

|   |           |   |           |
|---|-----------|---|-----------|
| <b>1.0 Description</b>                                  | (page 35) |   |           |
| <b>2.0 Features</b>                                     | (page 35) |   |           |
| <b>3.0 Application</b>                                  | (page 37) |   |           |
| 3.1 Safety instructions                                 | (page 37) |   |           |
| 3.2 Installation instructions                           | (page 37) |   |           |
| 3.3 Electrical connection                               | (page 37) |   |           |
| 3.4 Technical data                                      | (page 38) |   |           |
| 3.5 Dimensions illustration                             | (page 38) |   |           |
| <b>4.0 Power Reserve</b>                                | (page 39) |   |           |
| 4.1 Battery loading                                     | (page 39) |   |           |
| 4.2 Battery changing                                    | (page 39) |   |           |
| <b>5.0 Initial Operation</b>                            | (page 40) |   |           |
| 5.1 Entry adjustment                                    | (page 40) |   |           |
| 5.2 Setting date and time                               | (page 41) |   |           |
| 5.3 Selection schedule for automatic Summer/Winter time | (page 41) |   |           |
| 5.4 Changing automatic Summer/Winter time               | (page 42) |   |           |
| 5.5 Radio time switch                                   | (page 42) |   |           |
| 5.6 Connection and adjustment of the radio antenna      | (page 42) |   |           |
| 5.7 Initial operation of the radio time switch          | (page 44) |   |           |
| 5.8 Forced transmitter call                             | (page 44) |   |           |
| 5.9 Changing date/time                                  | (page 45) |   |           |
| <b>6.0 Manual Intervention in the Program</b>           | (page 45) |   |           |
| 6.1 Permanent switching <b>ON / OFF</b>                 | (page 45) |   |           |
| 6.2 Manual <b>ON / OFF</b> (override switching)         | (page 46) |   |           |
| 6.3 Random program                                      | (page 46) |   |           |
| 6.4 Random program <b>Start</b>                         | (page 47) |   |           |
| 6.5 Stop Random program/override switching              | (page 47) |   |           |
| 6.6 Locking/unlocking the keyboard                      | (page 47) |   |           |
| <b>7.0 Programming</b>                                  | (page 48) |   |           |
| 7.1 Programming weekly program                          | (page 48) |   |           |
| 7.2 Programming data program                            | (page 49) |   |           |
| 7.3 Programming single switching times                  | (page 49) |   |           |
|   |           | <b>7.4 Programming pulse program</b>                            | (page 50) |
|   |           | <b>8.0 Priority program</b>                                     | (page 50) |
|   |           | <b>8.1</b> Programming weekly program with P1-P9                | (page 52) |
|   |           | <b>8.2</b> Setting time period for the weekly program P1-P9     | (page 52) |
|   |           | A. Recurring annually   | (page 52) |
|   |           | B. Weekly Program only in one specified year                    | (page 53) |
|   |           | C. Stipulating public holiday without fixed date                | (page 53) |
|   |           | <b>8.3</b> Time limited permanent switching                     | (page 54) |
|   |           | <b>9.0 Program Interrogation</b>                                | (page 54) |
|   |           | <b>9.1</b> Interrogating only designated switching times        | (page 54) |
|   |           | <b>9.2</b> Whole program Interrogation                          | (page 55) |
|   |           | <b>9.3</b> Interrogation of channel related date program        | (page 55) |
|   |           | <b>9.4</b> Interrogate channel-related date program             | (page 55) |
|   |           | <b>9.5</b> Interrogate weekly program with priority             | (page 56) |
|   |           | <b>9.6</b> Interrogate astro program                            | (page 56) |
|   |           | <b>10.0 Changing a stored program</b>                           | (page 57) |
|   |           | <b>11.0 Cancellation</b>  | (page 58) |
|   |           | <b>11.1</b> Cancellation of individual switching times          | (page 58) |
|   |           | <b>11.2</b> Cancellation of date program                        | (page 58) |
|   |           | <b>11.3</b> Cancellation of priority program                    | (page 59) |
|   |           | <b>11.4</b> Complete program cancellation of one channel        | (page 59) |
|   |           | <b>11.5</b> Cancel everything                                   | (page 60) |
|   |           | <b>12.0 Data Exchange / Security</b>                            | (page 60) |
|   |           | <b>12.1</b> Entering data from time switch onto the memory card | (page 61) |
|   |           | <b>12.2</b> Reading data from memory card into time switch      | (page 61) |
|   |           | <b>12.3</b> Preview programming with software                   | (page 61) |
|   |           | <b>13.0 Tips and Dodges</b>                                     | (page 62) |
|   |           | <b>14.0 Glossary</b>  | (page 63) |
|   |           | <b>15.0 Table of errors</b>                                     | (page 64) |

### 1.0 Description

- 1 Display dat exchange with **Obelisk**
- 2 Interface for **Obelisk 64K**
- 3 Hour
- 4 Cursor for menu selection
- 5 Display date day
- 6 Display month
- 7 Display year
- 8 Second symbol (displays the impulse length in sec. togehter with **7**)
- 9 DCF77 receive display
- 10 Impulse symbol
- 11 Display 1x switching times
- 12 Display for astro switching times (sunrise, sunset)
- 13 Additional information for switching status display **r** = random/  
**P 1... 9** = priority level/ **H** = Manual / **F** = Duration
- 14 Switching status
- 15 Channel number
- 16 Display weekday 1 = Monday ...
- 17 Symbol of public holidays without a fixed date
- 18 Keyboard for operation of the clock
- 19 Programming LCD of the BCU
- 20 Programming button of the BCU
- 21 Battery holder
- 22 Connection DCF77 antenna
- 23 Bus connection
- 24 Reset button
- 25 Mains connection for integrated antenna mains unit; connection necessary only for operation with DCF77 antenna

### 2.0 Features

- 16-Channel-Yearly Time Switch
- Time switch programming or PC programming using Windows from Win 95 / WIN NT / 2000 / XP with software **Obelisk**
- The time switch can be programmed up to the year 2063 in advance
- Data transfer and security possible with memory card
- Data can be transferred from time switch to time switch, from time switch to PC and vice versa
- **Functions:** switching, dimming, transmitting time, receiving time
- BCU 2.1 integrated in unit
- 500 switchings for free block formation of channels and week days
- Stipulating public holidays without a fixed date
- Permanent switching times by means of EEPROM
- Day/Week/Year program
- Random program
- Pulse program
- Switching times: ON or OFF delay
- automatic stipulating of public holidays without fixed date
- 1x-function for all date-related switching times
- 10 priority programs consisting of 10 individual weekly programs per channel
- Time limited permanent switching ON/OFF
- Approx. 1.5 years battery reserve by means of exchangeable environmentally friendly lithium cell
- Channels 1 to 4 can be programmed as astro switching channels.

### Features of the Astro Function

#### What does the astro program mean for this switching clock?

On the basis of knowledge of the location of the switching clock (longitude and latitude), an astro program determines the astronomical times for sunrise and sunset automatically.

#### What does the switching clock do with the astro times?

The switching clock switches on and off according to astro values which are updated daily and re-calculated every day.

#### Which channels can be used for the astro function?

Astro functions can be used and implemented with channels 1 to 4 exclusively.

#### Generation and sending of astro data

An astro program can be generated only with the Obelisk 2.1 software and be transferred to the switching clock with the Obelisk 64K memory card.

#### What influence do the astro data have on the memory space?

The astro data do not occupy any of the 500 memory locations which are available for switching times.

#### Which priorities do the astro times have when overlapping normal switching times?

Priority programs identified as **P1 to P5** are implemented in addition to the switching time.

Nevertheless, priority programs **P6 to P9** suppress the astro switching times in case of an overlap of time.

### 3.0 Application

The time switch controls connected bus participants via a group address. It transmits either 1, 2 or 8-bit telegrams, including the time and the date. With the time program and the corresponding application, the time can be transmitted and received via the BUS. Transmission of current switch-time or date telegrams is only possible in automatic mode.

### 3.1 Safety instructions

-  Work on the European installation bus must only be carried out by qualified electrical technicians. National regulations and any valid safety conditions should be observed.
- > The time switch and the bus line must be connected in accordance with applicable DIN – VDE guidelines and the ZVEI/ZVEH Handbook.

The time switch:





- > Must only be operated with the data from the product database ...
- > Must only be used in dry areas.
- > The time switch is suitable for use in environmental conditions with normal pollution.
- > The time switch is suitable for mounting on the 35 mm hat rail.

Unauthorised modifications to the equipment render the warranty invalid.

### 3.2 Installation Instructions

In spite of expensive protection measures, exceptionally strong magnetic fields can lead to the destruction of the micro-processor controlled time switch.

**We therefore recommend attention be given to the following points before installation:**

-  Use separate lead for the mains voltage supply.
-  Suppress inductive loads with suitable RC filters.
-  Do not mount product in direct proximity to sources of interference as e. g. transformers, contactors, PCs and TV and communication equipment.
-  After suffering interference, we recommend, before re-setting, a RESET with a new initial set up (chapter 5.3).
-  Strongly heat-generating products on the right side of the product shorten the life of the battery.

### 3.3 Electrical Connection

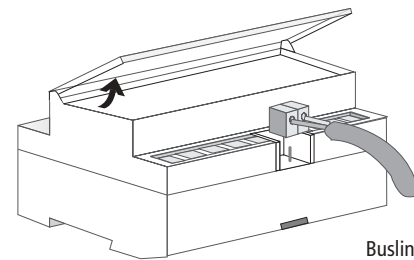



### 3.4 Technical Data

|                                     |   |
|-------------------------------------|---|
| <b>Description:</b>                 | <b>Yearly-Time-Switch</b>                           |
| Program Type:                       | Day/Week/Year                                       |
| Operating voltage:                  | Bus-connection                                      |
| Interval consumption:               | <150 mW incl. BCU                                   |
| Time Base:                          | Quartz  |
| Memory Locations:                   | 500   |
| Minimum Switching Time:             | 1 second/minute                                     |
| Minimum Pulse:                      | 1 second  |
| Switching Accuracy:                 | Accurate to the second or radio exact               |
| Accuracy:                           | ±1 sec./day at 20 °C                                |
| Power Reserve:                      | Lithium cell 1.5 years at 20 °C                     |
| Permissible Ambient Temperature:    | -5 °C ... +45 °C (-5T45)                            |
| Protection Class:                   | II if installed according to EN 60335               |
| Enclosure Type:                     | IP 20 in accordance with EN 60529                   |
| Time Base:                          | Radio exact<br>(with power reserve quartz operated) |
| Max. distance of the radio antenna: | 200 m   |
| Enclosure Type:                     | IP 54 in accordance with EN 60529                   |
| Max. Loading:                       | 10 products   |

Note deviating technical data on the rating plate.  
Rights to technical improvements are reserved.

### Note

The time switches conform to the European Regulations 73/23/EWG (low voltage rules) and 89/336/EWG (EMV-Regulations).  
If the time switches are used with other products in one installation, attention must be given to ensure that the whole installation does not cause radio interference.

### 3.5 Illustration of Dimensions

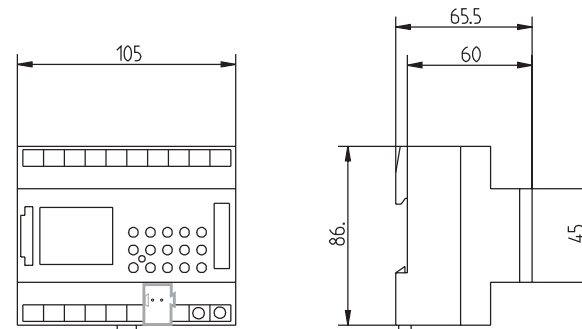

#### 4.0 Power Reserve

In the event of a power failure, the battery back-up provides for the maintenance of correct time (approx. 1.5 years). Even without power and with a drained battery, the switching times remain permanently stored.

#### 4.1 Battery Loading

- Note the polarity of the lithium battery.
- Insert the lithium battery into the holder (see diagram 1).
- Push the battery holder into the battery compartment.
- Press the battery holder down, until it audibly locates.

Dia. 1

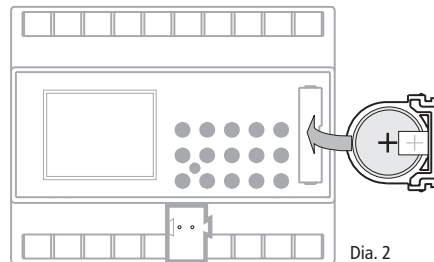
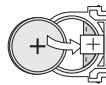

Dia. 2

#### 4.2 Battery Changing

##### Important Instructions

##### Battery changing with mains voltage

All memorised program data is maintained.

##### Battery changing without mains voltage

Note: date and time are lost.

1. Lift the battery draw with a suitable screw driver (see diagram 3).
2. Remove the lithium battery from the holder (see diagram 4).
3. Note the polarity of the new lithium cell.
4. Insert the Lithium battery into the holder (see diagram 1).
5. Push the battery holder into the battery compartment (see diagram 2).
6. Press the battery holder down until it audibly locates.
7. Dispose of lithium battery in an environmentally friendly way .

Dia. 3

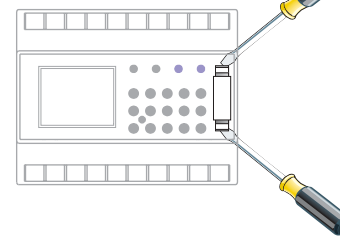

Dia. 4

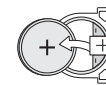



### 5.2 Setting date and time

On initial operation press button **RES** with a pointed object e.g. pencil, and afterwards release it.

**Example:**

The time switch is to be set up on 14.02.2002 at 13.28.

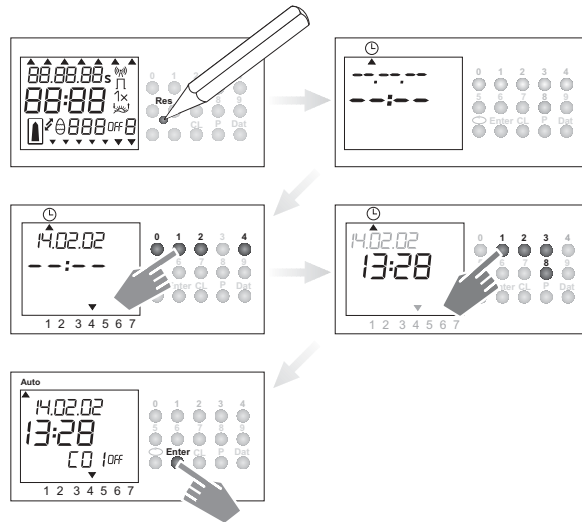

**Note:**

After the initial operation automatic Summer/Winter time is already programmed.

☞ Basic setting is for Central Europe: **dat 1**.

☞ If another or no change over standard is required, this can be changed at any time, as described in chapters 5.4.

### 5.3 Selection Schedule for Automatic Summer-/Winter time

| Setting      | Commencement   | Commencement                          | Area          |
|--------------|--|---------------------------------------|---------------|
| <b>dat 0</b> | no change  | no change                             |               |
| <b>dat 1</b> | last Sunday in March<br>2:00 → 3:00  | last Sunday in October<br>3:00 → 2:00 | EU            |
| <b>dat 2</b> | last Sunday in March<br>1:00 → 2:00  | last Sunday in October<br>2:00 → 1:00 | UK            |
| <b>dat 3</b> | 1st Sunday in April<br>2:00 → 3:00   | last Sunday in October<br>3:00 → 2:00 | North America |
| <b>dat 4</b> | individual Summer/Winter time table, programmable only with Obelisk software |                                       |               |

#### 5.4 Changing Automatic Summer/Winter time

##### Default dat 1

Select the new switching time (chapter 5.4).

**Example:** basic setting **dat 1**  
**Change to:** Switchover rule **dat 0**

**Note:** For radio controlled time switch is necessary.

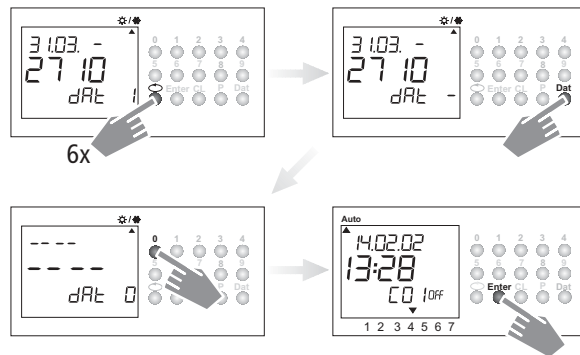

Back into automatic program with button  $\checkmark$ .

#### 5.5 Radio Time Switch

The operation of the radio time switch is exactly the same without DCF-antenna. The correct time, date and Summer/Wintertime change-over set themselves automatically with the DCF77 radio receiver.

##### Interesting Details:

- Accuracy of the radio receiver +/- 1 sec. in 1,000,000 years
- Transmitter location is Mainflingen near Frankfurt
- Transmitting radius of the transmitter approx. 1000 km
- Synchronisation is effected after initial setting-up and then daily at night.

#### 5.6 Connection and Adjustment of the Radio Antenna

We recommend the following mounting positions:

- outside the control box (at least 4 m away)
- under the roof
- or in a protected position outdoors

Avoid mounting positions near:

- radio transmitting installations
- radiological equipment
- television and personal computers

### A. Operation without DCF77 radio reception

1. Connect the bus line only. A connection to the 230V network is not necessary.
2. In this case, set the summer/winter change to the correct changeover standard, see chapter 5.3/5.4.

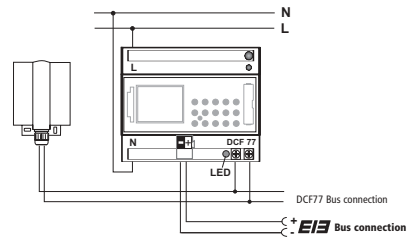

### B. FW/S connection with radio reception

1. Connect the radio time switch to the bus line and to the 230V mains. The 230 V mains voltage serves for the supply of the integrated antenna mains part.
2. Connect only antenna to the time switch. In this case, the polarity of the connection is very important. The antenna signal is safety extra-low voltage. Ensure that there is safe isolation from the voltage supply.

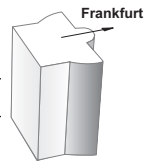

### C. Adjusting the DCF radio antenna

1. Set the radio antenna so that the LED installed in the front flashes at one second intervals.

### D. Connecting several radio time switches to the DCF antenna

fig. 1

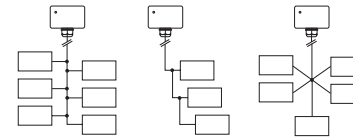

1. First, connect only **one** time switch to the 230 V mains supply.
2. After this, connect further time switch devices **to the antenna. Please observe polarity!**

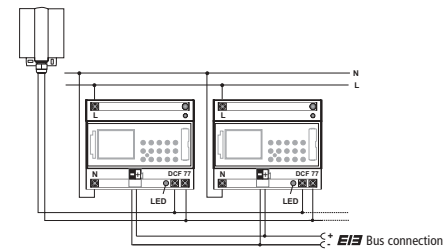

The connection to the DCF antenna may take the form of a star, bus or tree topology, see fig. 1).

**Note:** If an LED at the DCF lights up, simply reverse the polarity at this connection!

3. **Following this**, connect the other devices the 230 V mains supply.
4. Align the antenna, see chapter C.



### 5.7 Initial Operation of the Radio Time Switch

#### A. Setting-Up Automatically

**Note:** During synchronisation press **no** buttons!

The synchronisation test would be discontinued immediately. To obtain a new start after this, **RES** button must be pressed again.

1. The display counts from **00** to **59** (see illustration 2)  
Depending on the reception quality of the DCF77 signal, this procedure can be repeated several times.

2. If the time switch has completely received the **1<sup>st</sup>** signal  
 continues to flash (see ill. 3). The date, the weekday and the time will be shown on the LCD display. Only when a further signal is received, does the symbol  
 stop flashing, the channel statuses will be displayed (see fig. 4).  
The clock is now ready for operation.

#### B. Setting-Up Manually

**Tip:** If the clock, on the initial set-up, does not synchronise even after several attempts, possibly because of a disturbed reception signal, we recommend setting-up as described in chapter 5.2. The clock will then try once more to synchronise itself on the signal, during the night.

**Example:** The time switch has synchronised itself on 03.04.2002 at 10.20.

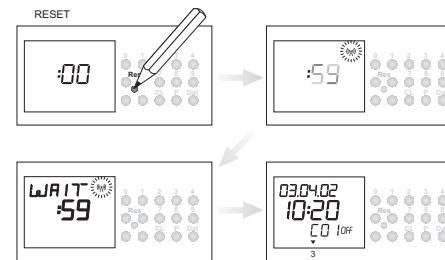

### 5.8 Forced Transmitter Call

The synchronisation of the time switch is effected after the initial setting-up, then daily between 1.00 and 3.00.

A radio synchronisation can be called up manually during the day (transmitter call).

#### Start of the Transmitter Call

1. Press **Dat** button for approx. 3 secs.
2. Then release.

The timeswitch synchronises itself on the DCF77 signal.

#### In the LCD display can be seen:

The  symbol flashes only during a DCF77 synchronisation!

If the time switch has synchronised itself, a program review takes place.

The channels take on, afterwards, the specified switching positions, from the individual program.

The  symbol is permanently in the LCD display.

### 5.9 Changing Date / Time

With the cursor in Pos. 1, any flashing value, the actual time or date, can be changed with the buttons 0 ... 9.

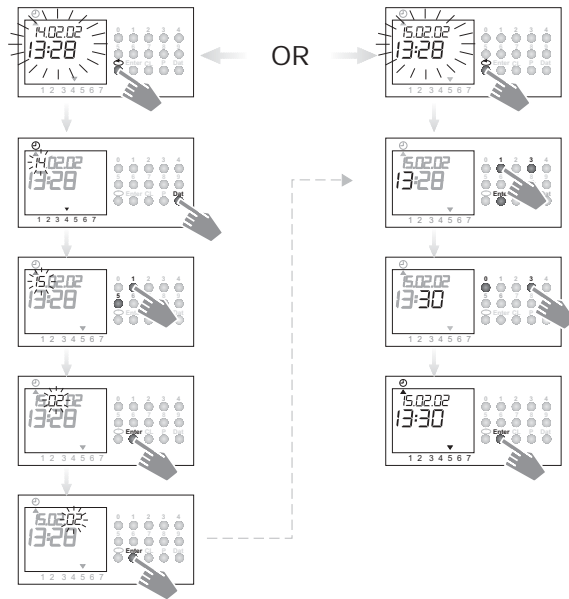

- Press **Enter** repeatedly, until the cursor is below Auto
- or follow the line and change the actual time.

### 6.0 Manual Intervention in the Program

#### 6.1 Permanent ON / OFF

Each channel can be manually switched in automatic menu to permanently **ON**. A permanent switching has highest priority. The channel remains in the permanently ON switching position until manually cancelled.

**Example: Channel 1 permanent ON.**

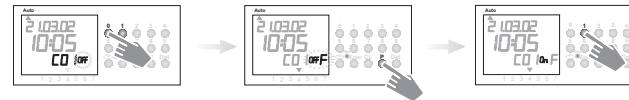

**Example: Channel 1 permanent OFF.**

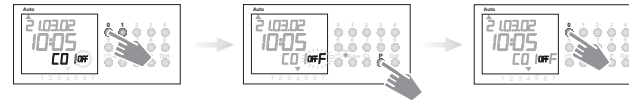

Each channel can be manually switched in automatic menu to permanently **OFF**. After cancellation of a permanent switching the time switch effects a program recall. This results in the time switch checking the stored program and implementing the correct switching condition.



### 6.2 Manual ON / OFF (override switching)

Each channel can be switched **ON** manually in the automatic program. In which case, the symbol **H = hand** appears in the display.  
 An override switching is cancelled again by the next switching command. The **H** display is turned off.

**Select channel 1:** Button **0** and **1**

**Select channel 2:** Button **0** and **2** = channel etc.

**Select status:** Button **1** = switch on, button **0** = switch off

**Example:** Switch channel **C1** on manually

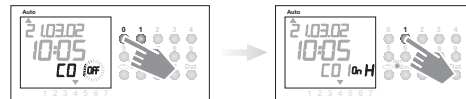

Each channel can be switched **OFF** manually in the automatic program. An override switching in the automatic program is corrected again by the next switching command. (The **H** symbol is turned off).

**Select status:** Button **1** = switch on, button **0** = switch off

**Example:** Switch channel **C1** off manually

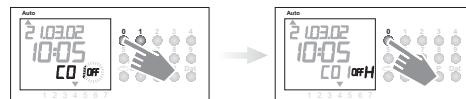

### 6.3 Random Program

#### General Comment

A random program causes the time switch to switch ON or OFF at random between one or more pairs of switchings (ON and OFF switching time).  
 Duration of the random ON and OFF switching time approx. **10 –120 minutes**.  
 The random program can be selected individually for each time channel.

#### Example:

Between 19.00 and 22.00 random ON (display:r)

Between 0.00 and 06.00 random ON (display:r)

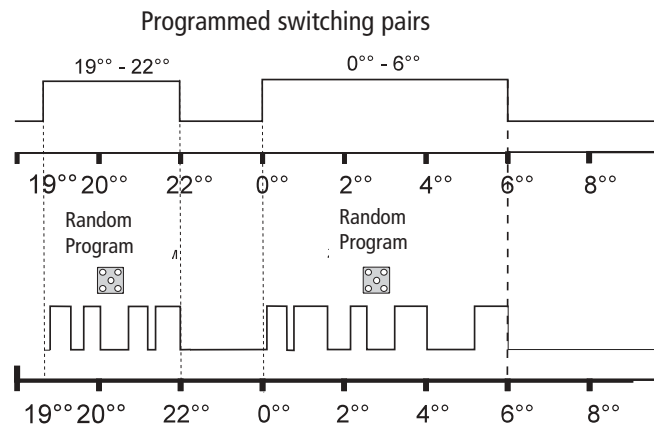

#### 6.4 Random Program Start

A random program can be switched ON manually in the automatic program (Auto) at any time. It remains active until switched OFF (chapter 6.5).

**Note:** If the random program is active in a channel, the symbol **r** (random) appears beside the channel.

**Example:** Switch ON random program in Channel C1.

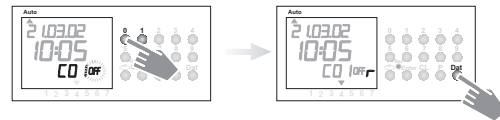

#### 6.5 Stop Random Program / override switching

A random program override switching can be interrupted at any time. After cancellation of the random program override switching, the time switch carries out a program review. This causes the time switch to inspect the stored program and then take up the correct switching status.

**Example:** Stop random program Channel C1

**Note:** The symbol **r** turns OFF.

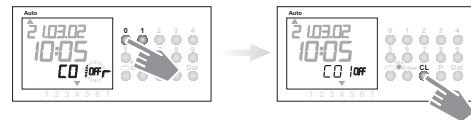

#### 6.6 Locking/ unlocking the keyboard

##### Effect:

The memory card allows you to prevent operation of the device by unauthorized persons. In this case time switch query and programming are impossible without the memory card.

##### Locking the keyboard:

1. Insert the memory card into the data interface.
2. Press key **8** for approx. 3 secs until the **Obelisk** icon  is flashing.

##### Operating the time switch

If after a button is pressed and the Symbol  is blinking, the keyboard is locked.

1. Insert the memory card into the data interface.
2. You can select the desired program using the  $\vee$  key.
3. Now you can remove the memory card in order to continue programming. When the time switch returns to auto mode, the keyboard is locked.

##### Canceling the keyboard lock

1. Insert the memory card into the data interface.
2. Press key **P** until the icon  appears.
3. Press key **P** for approx. 3 secs until the icon disappears.
4. Remove the memory card.

Now the time switch can be operated again without obstruction.

7.0 Programming

7.1 Programming Weekly Program

e.g.: Channel C3 is to switch on at 7.30 from Mon to Fri **ON**

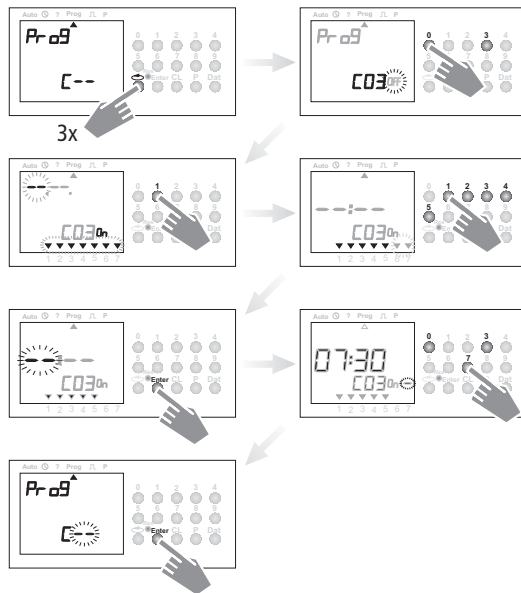

Example 2: Weekly program – set switch OFF time

– Channel C3 is to switch OFF at 18.30 from Mon to Fri

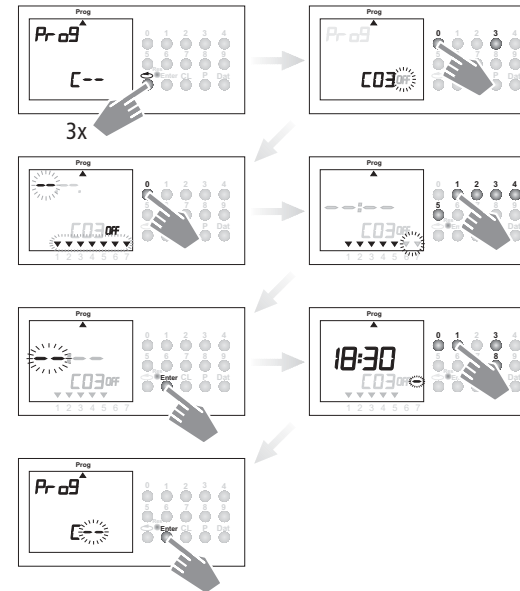

Additional programming as described, or back into the automatic program with button √ .

### 7.2 Programming Data Program

**Example.:** Channel C3 is to switch ON on the 1.5 at 7.30

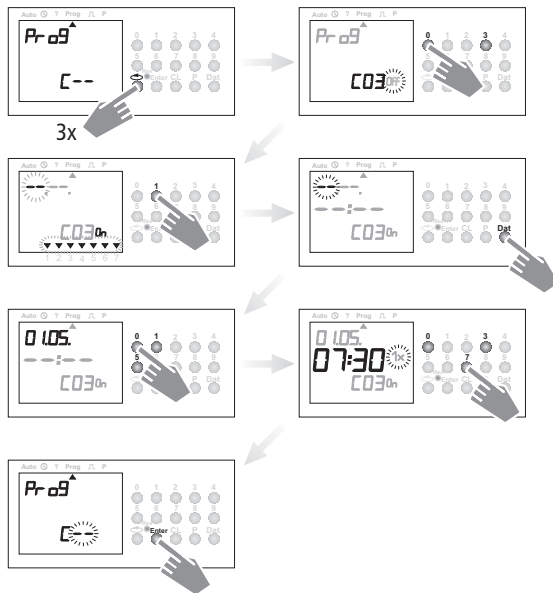

Additional programming as described or back into the automatic program with button v .

### 7.3 Programming Single Switching Times

**Example:** Channel C3, 1 switch ON on the 10.5 at 8.30

**Note:** Only date related switching times can be programmed with the function 1x see illustration 7. Once the switching time is effected, it cancels itself automatically at mid-night.

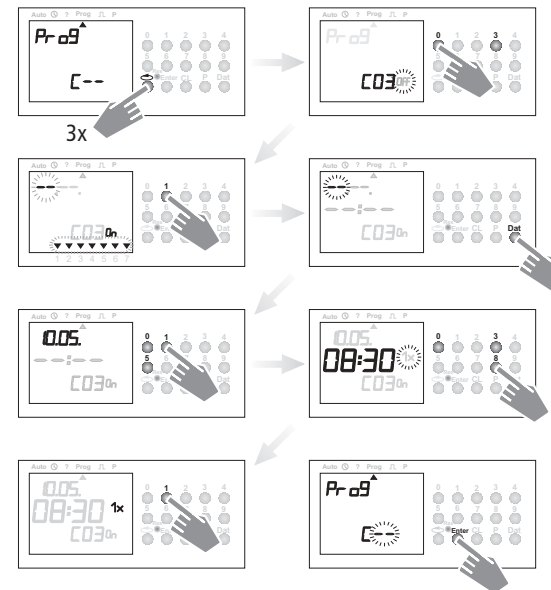

### 7.4 Programming Pulse Program

**Example:** Channel C2 pulse duration: 5 secs from Mon to Fri at 7.15.

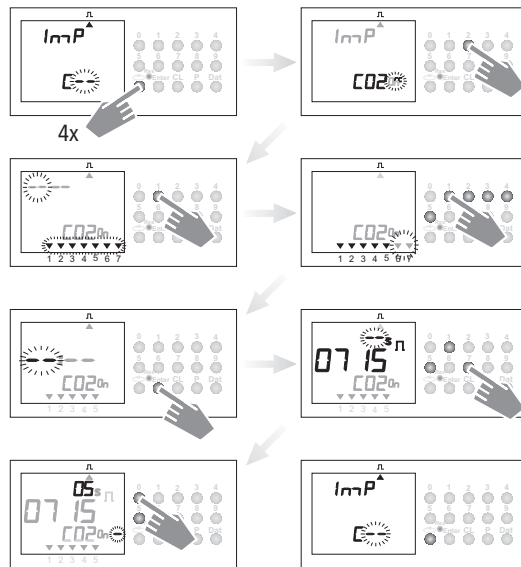

**Note:** After a time adjustment, pulses are only effected, which are programmed at least one minute after the time adjustment.

### 8.0 Priority Program

With the time switches up to 9 different weekly programs can be performed in addition to the normal weekly program. A firm weekly program P1 ... P9 can be requested at any fixed periods of time.

That is, the programming consists of:

1. Setting the weekly program (see chapter 8.1).
2. Setting commencement and completion date (see chapter 8.2).

If the time period of several weekly programs cut across one another, the program with the highest index number prevails e.g. weekly program P9 prevails over weekly program P3.

In order to maintain control, we recommend that the various weekly programs are noted in the table at the end of the user instructions or to be loaded in the **Obelisk** software and printed out.

Switching times are executed in the following order:

- Permanent switching
- 1x switching times. chapter 7.3.
- Time limited permanent switching. chapter 7.3 (out priority over ON).
- Date switching times. chapter 8.3 (out priority over ON).
- Weekly program with priority. chapter 8.2/8.3 (P9 priority over P1).
- Weekly program. chapter 7.1/7.2.
- etc.

Weekly Program Schedule with Priority

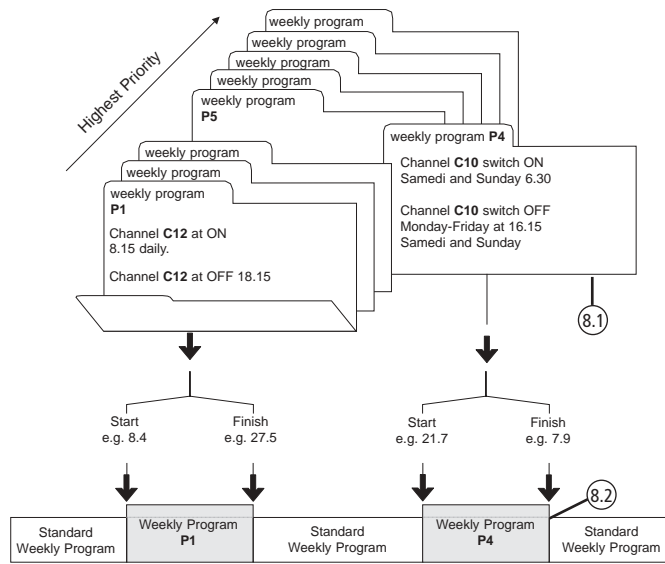

When changing to a new weekly program (e.g. on 8.4 at 0.00 hr), all channels in question are switched as if the new weekly program has been valid for some time. This means the new weekly programme makes a review of the program.

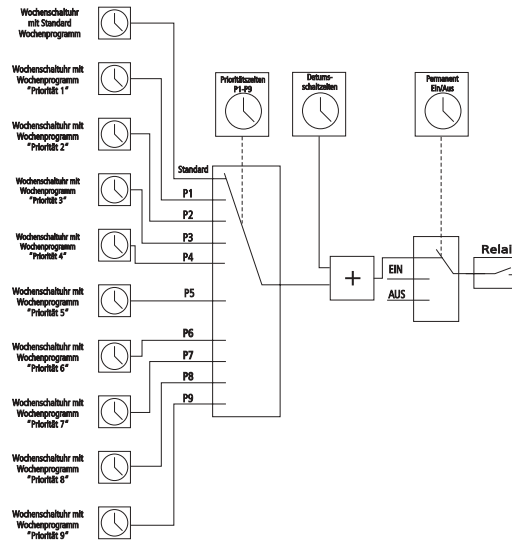

### 8.1 Programming Weekly Program with Priority P1 .. P9

**Example** Channel C12 switch on daily at 8.15  
Weekly program gets priority sequence P1.

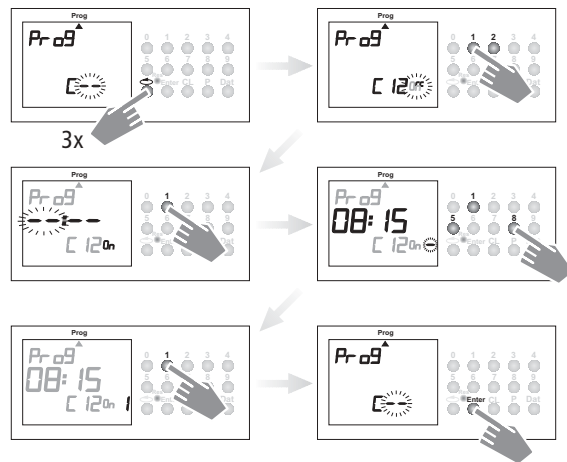

**Note:**  
Pulse switching times can also be fixed with priority sequence. For weekly programs with priority, any number of ON/OFF switching commands can be specified.

### 8.2 Setting Time Period for Weekly Program P1 .. P9

#### A. Recurring annually

The time period of a weekly program P1 .. P9 is fixed by entering a commencement and finishing date. The weekly program begins at 0.<sup>00</sup> on the commencement date and ends at 24<sup>00</sup> on the finishing date.

**Example:** As opposed to the normally active program on Channel C12 from 8 April until 27 May, the individual priority program with index P1 is to become effective. In the fixed time period with priority sequence P1 .. P9, the whole standard program (without priority sequence) is suppressed.

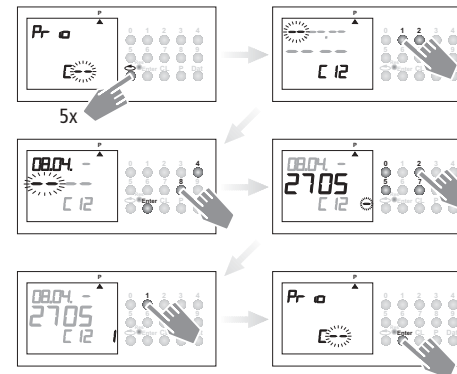

Additional programming as described or with button  $\checkmark$  back into the automatic program.

### B. Weekly program only in one specified year

**Example:** Only in year 2002 from 8th April to 27th May, e.g. the weekly program P2 activated.

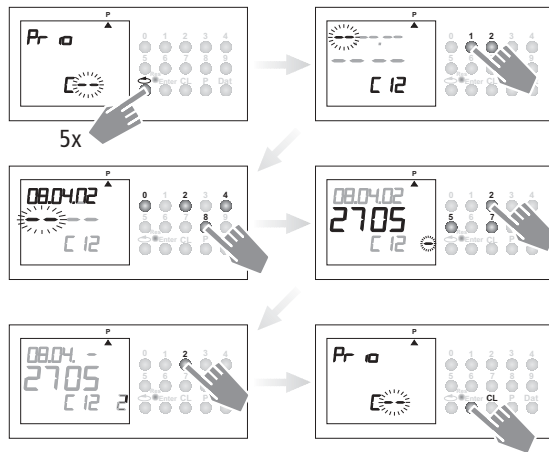

### C. Stipulating public holidays without a fixed date

**Example:** Following this measure, a public holiday such as Whitsun (not a fixed date) will be activated automatically and will execute, e.g., program P2.

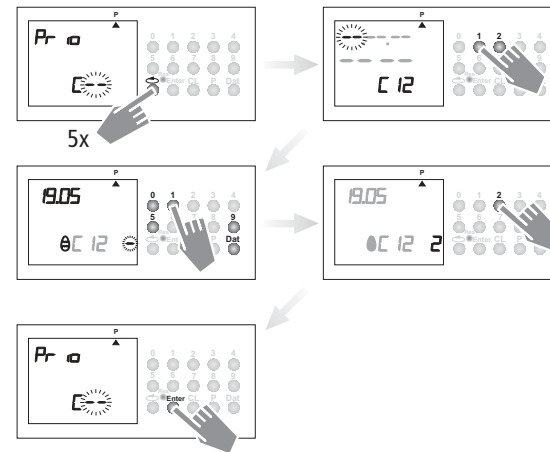

Programming of public holidays without fixed dates only needs to be carried out once, e.g. following initial start-up. This applies to holidays connected with Easter such as Ascension, Whitsun, Corpus Christi, Ash Wednesday, Good Friday etc. Program the date of **all** of these holidays that do not have a fixed date **once** only for the **current** year.



### 8.3 Time Limited Permanent Switching ON / OFF

E.g.: All connected equipment is to remain switched OFF during the Christmas holidays between 23 December 2002 and the 7 January 2003.

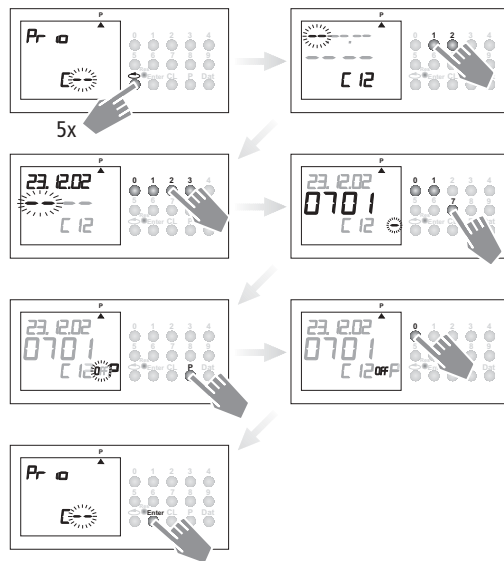

Additional programming as described or with button √ back into the automatic program.

### 9.0 Program Interrogation

#### 9.1 Interrogating Only Designated Switching Times

1. Illustration: menu selection and display of the free memory locations e.g. 480
2. Illustration: e.g. select channel e.g. C3 (press button 3)
3. Illustration: begin interrogation e.g. from Mondays: button 0, 1 press.
4. Illustration: Interrogate further switching times

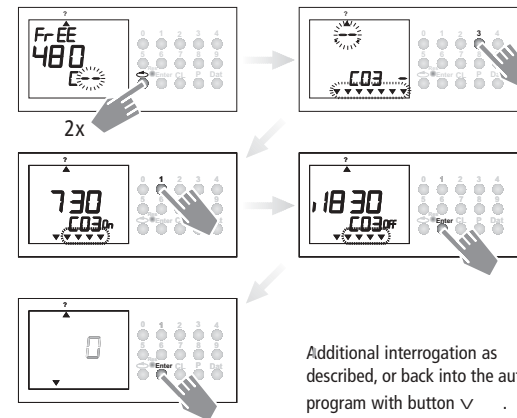

Additional interrogation as described, or back into the automatic program with button √ .

### 9.2 Whole Program Interrogation

Menu Selection cursor under ?  
By pressing **ENTER** button (several times) interrogate whole program.

With button  $\vee$  back into the automatic program (Auto).

### 9.3 Interrogation of Channel Related Date Program

The complete interrogation of the date program is effected as described in 9.3.  
The entry step in illustration 4 (button 0,1) must be omitted in this case.  
All stored date-related switching times will be shown one after the other from January (01).

### 9.4 Interrogate Channel-Related Date Program

**Illustration 1:** Menu selection and display of the free memory locations, e.g. 480

**Illustration 2:** Select channel, e.g. C3, press button 3, Select date program, press **Dat** button

**Illustration 3:** Start interrogation, e.g. from May press button 5 (Interrogation from February, press button 2, etc.)

**Illustration 4:** Search for the desired switching times, press the **Enter** button  
For example: On 1 May, channel C1 will be switched on at 7.30 hrs

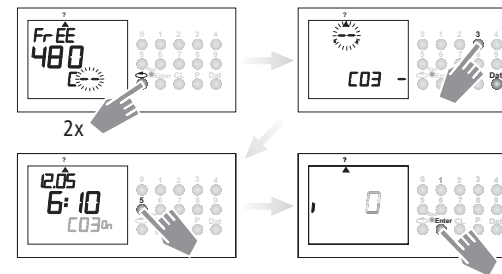

### 9.5 Interrogating weekly program with priority

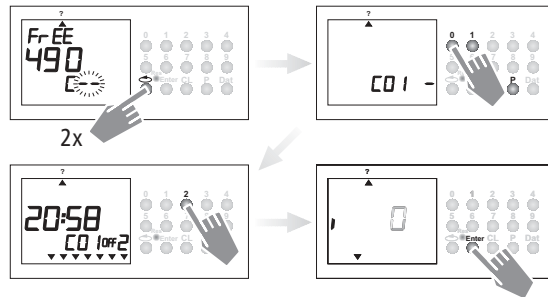

- Fig. 1:** Display of available memory space **490**
- Fig. 2:** Select: Channel **C1**  
Only have priorities displayed, press button **P**
- Fig. 3:** Priority selection, have everything displayed with priority 2
- Fig. 4:** Press **Enter** to have further programs with priority 2 displayed



**Note:** If, while in interrogation mode, a date, the year and the symbol  are displayed, then this indicates a public holiday without a fixed date.

To cancel: Press button  to return to the automatic program.

### 9.6 Interrogate Astro Programs

- Illustration 1:** Display memory locations still free **480**
- Illustration 2:** Selection of e.g. Channel **C3**
- Illustration 3:** With **Enter** button, search for switching time and (or have displayed. Symbol  shows the time calculated for sunrise.
- Illustration 4:** With **Enter** button, search for further switching time and/ or have displayed. Symbol  shows time calculated for sunset.

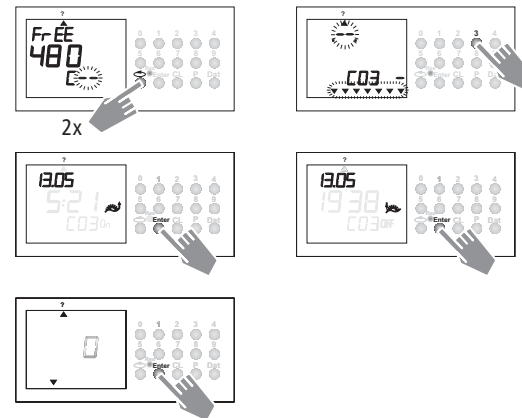

### 10.0 Changing Stored Program

Every stored program, no matter whether weekly or yearly program, can be changed to meet individual requirements.

**Requirement:** Cursor must be in Pos. **Auto** ☉ **? Prog** ⏏ **P** ☼ / ☼.

**Example:**

**Illustration 1:** Example: Free memory locations **470**

**Illustration 2+3:** By pressing the **Enter** button, the switching time to be changed can be searched for and displayed step-by-step.

#### Information for all further steps:

**Change:** Use button **0** to **9**.  
**Do not change:** Confirm the setting displayed and move to the next setting with the **Enter** button.

**Illustration 4:** Start with **P** = correction button

**Illustration 5:** **Change:** e.g. Channel C14 off (Ill. 3) to Channel C7 off

**Illustration 6:** Switching status e.g.: Off with **0** button, On with **1** button

**Illustration 7:** Switching time is still made daily for moment (see ill.)

**Change weekdays:**

e.g. **not** Sat, Sun

Press **6** and **7** buttons

**Illustration 8:** Save change

**Illustration 9:** Change time

**Illustration 10:** Save and return to display of free memory locations.

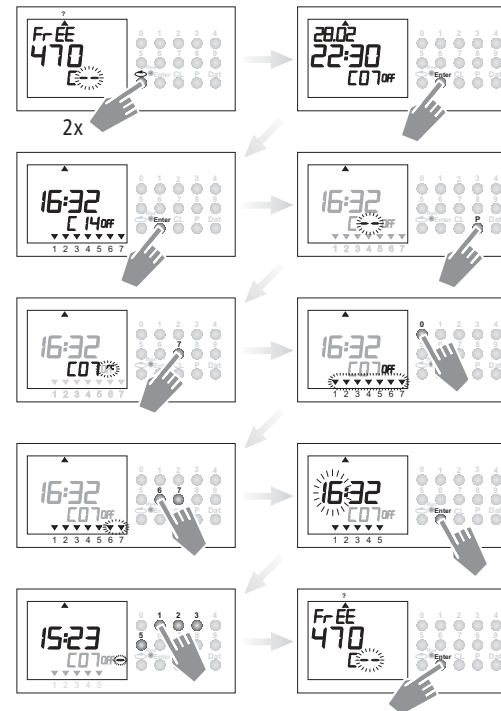

Additional changes as described, or back into the automatic program (Auto) with button **☉**.

## 11.0 Cancellation

### 11.1 Cancellation of Individual Switching Times

**Illustration 1:** Menu selection ? and display of free memory locations e.g. 470

**Illustration 2:** Search for switching times: Press **Enter** button

**Illustration 3:** Delete: Press **CL** button and then **Enter**

Cancel deletion process: Press **CL** button instead of **Enter**

**Illustration 4:** **Enter** button: Memory looks for further switching times

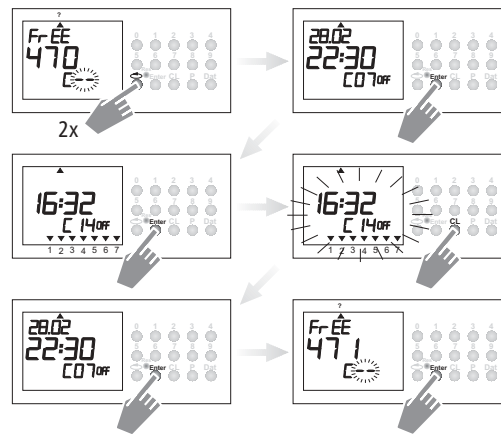

Continue cancellation as described, or back into the automatic program (Auto) with button  $\nabla$ .

### 11.2 Cancellation of Date Program

**Illustration 1:** Menu selection ? and display of free memory locations e.g. 480

**Illustration 2:** Select channel, e.g. C3, press **0** button and then **3**

Select date switching times, press **Dat** button

**Illustration 4:** Start query from February: Press **0**, **2** buttons (March 0 and 3)

Search for switching time to be deleted: Press **Enter** button

**Illustration 5:** Delete the switching time: Press **CL** button and then **Enter**

Cancel deletion process: Press **CL** button instead of **Enter**

**Illustration 6:** **Enter** button: Memory looks for further switching times

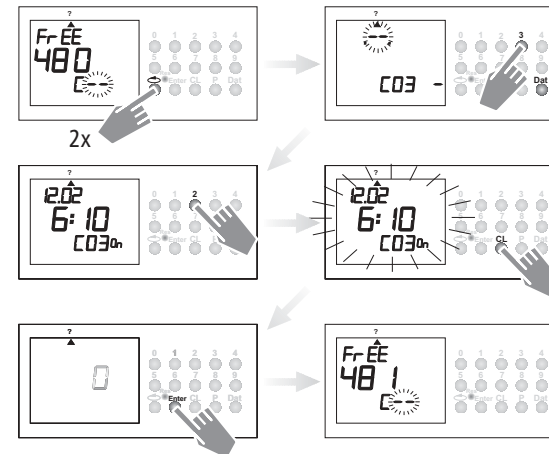

Continue cancellation as described, or back into the automatic program (Auto) with button  $\nabla$ .

### 11.3 Cancellation of the Priority Program

- Illustration 1:** Menu selection ? and display of free memory locations e.g. 152
- Illustration 2:** Initiate the cancellation procedure, press CL button
- Illustration 3:** Select channel e.g. C1, press Button 0 and 1
- Illustration 4:** Select the priority program for cancellation e.g. P6, press button 6  
Discontinue cancellation procedure, press CL button again
- Illustration 5:** Confirm cancellation procedure, press Enter button

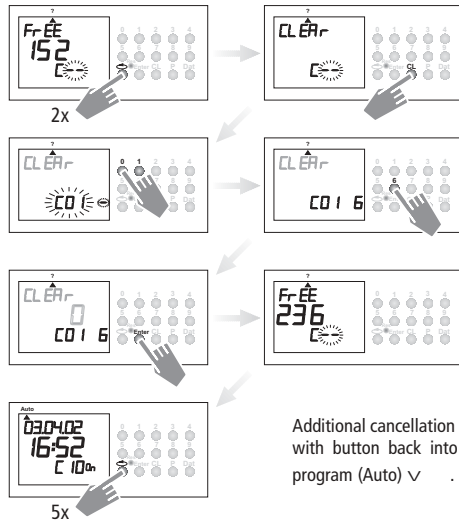

Additional cancellation as described, or with button back into the automatic program (Auto) ✓

### 11.4 Complete Program Cancellation of One Channel

The program of one channel can be cancelled completely. The cancellation is effected as described in chapter 11.3. The entry step in Illustration 3 (button 6) must be omitted in this case.

### 11.5 Cancel Everything

**Illustration 1:** Menu selection ? and display of free memory locations e.g. 162

**Illustration 2:** Cancel program, press button CL

**Illustration 3:** Cancel everything, press button 0

Discontinue cancellation, press CL button again

**Illustration 4:** Confirm cancellation, press Enter button

**Illustration 5:** Display 500 memory locations, all switching times are cancelled

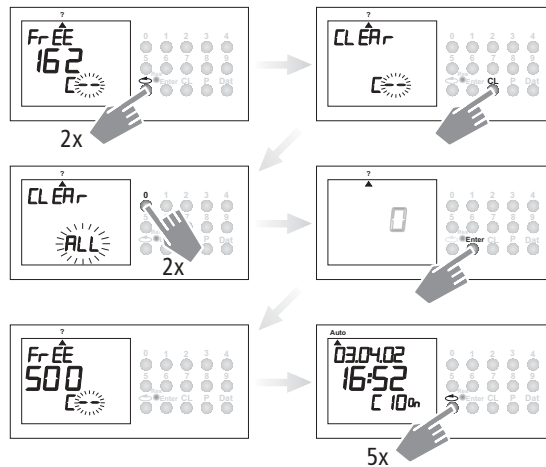

With button ∇ back into the automatic program (Auto).

### 12.0 Data Exchange / Security

The program prepared with the Obelisk 2.1 software can be exported and stored in the memory card.

The data can:

- be archives or
- be transmitted and read from
- time switching clock to time switching clock or from
- time switching clock to the software.

III. 4

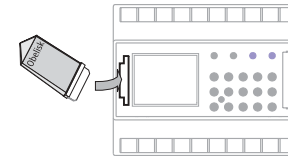

The Obelisk 64K memory card can be used exclusively for the transmission of data of this switching clock.

Data transmission with the Obelisk 64K memory card is not possible for the 4-channel time switches 5WG1 372-5EY01 and 5WG1 372-5EY02.

### 12.1 Entering Data from Timeswitch onto Memory Card

1. Insert the memory card into the data interface (ill. 4)
2. Select menu ?
3. Write data onto the memory card: Press the **Enter** button.

info: The data will be exported when the **End** symbol is present in the LCD display. If the Obelisk 64K memory card is withdrawn too soon, all stored switching times of the time switching clock will be deleted (see table in chapter 16).

4. Remove the memory card.
5. Change back into the **Auto** menu by pressing the **Enter** button.

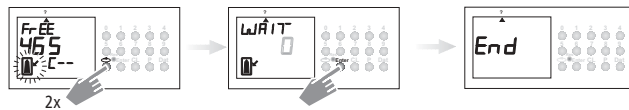

### 12.2 Reading Data from Memory Card into Time Switch

1. Insert the memory card into the data interface (ill. 4).
2. Select the **Prog** menu.
3. Read in data: Press the **Enter** button.

info: The data will be exported when the **End** symbol is present in the LCD display. If the Obelisk 64K memory card is withdrawn too soon, all stored switching times of the time switching clock will be deleted (see table in chapter 16).

4. Remove the memory card.
5. Change back into the **Auto** menu by pressing the **Enter** button.

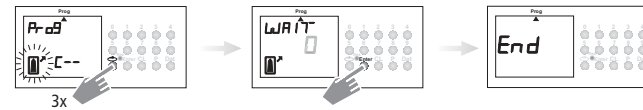

### 12.3 Preview Programming with Software OBELISK

The possibility exists for preparing a program on the computer with the software program. The prepared program can be written onto the memory card and also be printed out. The memory card can now be as secure data or for reading into another time switch.

- Condition:**
- PC from 486 free hard disk storage capacity approx. 1 MB
  - from WIN 95 / WIN 98/ WIN 2000/ XP/ WIN NT

**You will require:**  
**Obelisk 2.1 + Obelisk-Interface V2.0 program software + Obelisk 64K memory card.**

#### Attention!

Do not use the memory card 5WG1 810-8EY01 with the 16-channel time switch with DCF77 connection REG 373!

Please consult our Customer Service Department.

Functional diagram

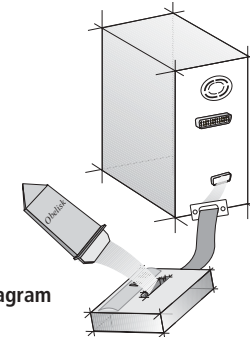



**13.0 Tips and Dodges**

**1. Priority Program with Random Switching**

Possibility for starting a random program automatically during public or annual holiday times.

1. Program weekly program with the desired ON and OFF switching times and priority sequence **P1 .. P9** (chapter 8.1)
2. Specify the time period for the weekly program (chapter 8.2).
3. Activate random program once manually (chapter 6.4).

**2. Special Program for holidays**

Procedurally during holidays to switch ON and OFF connected units at different times:

1. Program your desired holiday program. The ON and OFF switching times must occur daily. A priority sequence **P1..P9** must be assigned to the switching times (chapter 8.1).
2. Specify the time period for the weekly program e.g. only for the 1st May → begin 01.05 finish 01.05 (chapter 8.2).

**3. Pulse Program for Time delayed Switch-ONs**

A switch-ON time e.g. at 7.0 and 10 secs can be achieved by:

1. programming a switch-ON time e.g. 7<sup>00</sup> ON (O) (chapter 7.1)
2. Additional pulse program (chapter 7.4) with same switch-ON time.

1. Switch-ON time e.g. 7<sup>00</sup> O
2. Additionally at 7<sup>00</sup> pulse OFF (P) for the duration of 10 secs
3. Effective at 7<sup>00</sup> 10 secs switch ON

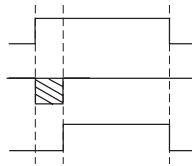

**Note:** After a time adjustment, only pulses, which are programmed at least 1 minute after the time adjustment, are carried out.

**4. Pulse Program for Time Delayed Switch-OFF**

A switch-OFF time e.g. at 8.0 and 10 secs. can be achieved by:

1. Programming a switch-OFF time eg.g. 8<sup>00</sup> (chapter 7.1)
2. Additional programming of a simultaneous pulse switching time of 10 secs. duration.

1. Switch-OFF time e.g. 8<sup>00</sup> OFF P
2. Additional pulse ON (O) at 8<sup>00</sup> for 10 secs duration
3. Effective at 8<sup>00</sup> 10 secs. switch OFF.

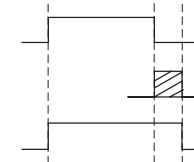

**Note:** After time adjustment, only pulses, which are programmed at least 1 minute after the time adjustment are carried out.

#### 14.0 Glossary

##### What does automatic operation (Auto) mean?

The cursor is below **Auto**. Current time is displayed.  
The switching sequence of the time switch is determined by the stored switching times.

##### What is automatic return?

When in the interrogation or programming mode, if no button is used for a long time, the display reverts automatically, after approx. 40 secs. to automatic operation. The product then takes up the switching status specified by the program.

##### Program recan?

This results in the time switch checking the stored program and implementing the correct switching condition.

##### What does entry correction mean?

In the event of wrong entry during programming, by pressing the CL button, the entry can be cancelled and immediately corrected.

##### What does weekday block formation mean?

Simultaneous programming at one switching time e.g. 6<sup>00</sup> ON on several days of the week e.g. Monday, Tuesday and Friday.  
Only one memory location is used.

##### What does channel block formation mean?

Simultaneous programmed switching times, which are effective in several channels, take up only **one** memory location.  
**Advantage:** Faster programming of the switching times.

##### What does the astro program mean?

On the basis of knowledge of the location of the switching clock (longitude and latitude), an astronomical program determines the astronomical times for sunrise and sunset automatically.  
The switching clock switches On and Off according to astro values which are updated and re-calculated daily. The astro program can only be programmed through the **Obelisk software**.

##### What does memory card mean?

Mobile data carrier can be used for:

- security of the programmed time program
- duplication of the programmed time program
- faster programming of additional time switches with the same program

##### Option only with software Obelisk:

- programming on the PC, store on memory card
- read program into time switch(es)
- program print out possible

##### What does RESET mean?

By pressing the RESET button, a defined new start for the time switch is effected. The current time and date are cancelled. The stored switching times are maintained permanently.

##### What does EEPROM mean?

An EEPROM is an electronic memory, which can store memorised data even without current (without battery back up) for a period of approx. 40 years.

##### What is an LCD?

An LCD display is a liquid crystal display, with which current time and stored data (switching times) can be shown.

### 15.0 Table of errors

In order to increase the reliability of operation, several internal tests are run by the time switch. If any error appears during these tests, the LCD will display the following error numbers.

**Error no. 4, 5, 6, 7:**

Error in the transmittance of data memorized in the memory card.

1. Transfer program once again onto program card.
2. Repeat transaction.
3. No success.

**Error no. 3:**

Program card has been withdrawn prior to end of data transfer.

Repeat transaction.

**Error no. 1, 2, 8:**

Program memory defect.

