

Transponder Reader
TR22A01KNX
TR22A11KNX

Product Handbook



Product: **Transponder Reader**
Order Code: **TR22A01KNX - TR22A11KNX**
Application Program ETS: **EEL_RDT1_10 Transponder Card Reader**

Index

		Pag.
1	General Introduction	3
2.	Technical data	4
2.1	Wiring Diagram	5
2.2	Operating and display elements	5
2.3	Dimension drawing	5
2.4	Mounting and wiring hints	6
3.	Product and functional overview	7
4.	Parameters	9
4.1	Parameter window “General Configurations”	9
4.2	Parameter Window “Relay 1 Configuration”	11
4.3	Parameter Window “Relay 2 Configuration”	14
4.4	Parameter Window “Input 1 Configuration”	15
5	Communication Objects	18
6	Application Notes	22

1 General Introduction

Eelectron is an Italian company with a focus on designing and manufacturing electronic devices dedicated to building and home evolution and closely related software tools.

As of year 2005, Eelectron applies to KNX association, fulfilling his requirements with the main goal of giving a contribution to the diffusion of the world's only open Standard for home and building automation.

Eelectron philosophy of comprehensive aesthetic design and engagement in developing highly innovative devices, matched with KNX Interoperability and compliance with international requirements, has engendered Eelectron's distinct reputation.

Eelectron experience is devoted to end users, with a constant training activity, assistance on products and a continuous development that deserves particular attention to upcoming needs and applications, to energy saving and to solutions directed to make Users life easier and simpler.

2. Technical data

Transponder Reader



Order Code :
TR22A01KNX (Light Grey Varnished)
TR22A11KNX (Dark Grey)

The Transponder Reader TR22A01KNX is an EIB/KNX wall mounting device suitable to access control application. This device can be used in any kind of building (Hotel, Hospital, Offices, Parking, etc..) where the access control application is required.

The device is equipped with two binary inputs (potential free contacts) that can be used, for instance, to control whether the door lock has been opened or closed or other signals coming from external switches/contacts (i.e. windows, bathroom emergency alarms, etc..).

The transponder reader is equipped also with two output relays which can be used for any purposes, typically to open the door or turning on the courtesy light inside the room.

The device configuration for commissioning in terms of physical address, group addresses and parameters is done with ETS (Engineering Tool Software) through a download of the Application Program.

Power Supply	External Auxiliary Voltage	<ul style="list-style-type: none"> • 12 (24) V AC/DC \pm 10%
Inputs	Number Input Signal Voltage Input Signal Current (close contact)	<ul style="list-style-type: none"> • 2 (potential free) • $U_n = 24V$ • $I_n = 1ma$
Outputs relays	Number Output switching currents	<ul style="list-style-type: none"> • 2 • 24 VAC, 2A cosp 0.6.
Control Elements	1 programming push button	
Display elements	1 LED red (back) for ETS programming 1 LED red/green (front) 1 LED red (front) 1 LED amber (front) 1 LED green (front)	<ul style="list-style-type: none"> • "Access Not Allowed/Allowed" signalling • "Room Occupied" or "Do not Disturb" o other alarm • "Room Service Call" o other alarm • "SOS alarm" o other alarm
Physical specifications and Dimensions	Housing Colours Dimensions Weight Installation	<ul style="list-style-type: none"> • plastic • Light Grey Varnished (TR22A01KNX), Dark Grey (TR22A11KNX) • (WxHxD): 110 x 78 x 37,1 mm • ca. 120 g. • flash mounting in 2-3 modules or wall round box \varnothing60mm, 40mm deep
Electrical Safety	Pollution degree Protection class Safety class Overvoltage category	<ul style="list-style-type: none"> • 2 (according to EN 60664-1) • IP20 (according to EN 60529) • III (according to EN 61140) • III (according to EN 60664-1)
CE Mark and Certifications	CE EIB/KNX	<ul style="list-style-type: none"> • In accordance with EMC and Low Voltage guidelines • According to EN 50090-1-2

2.1 Wiring Diagram

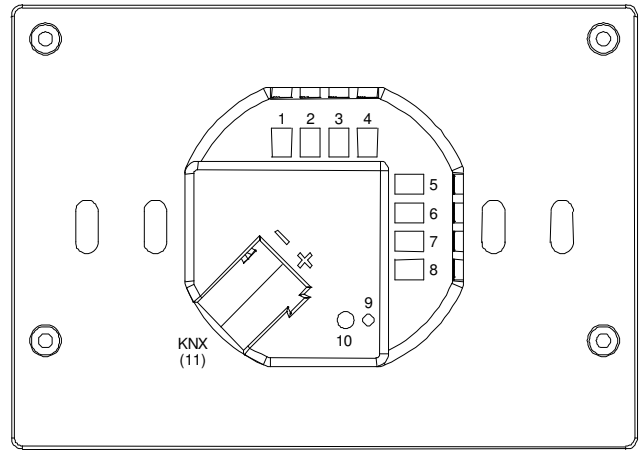
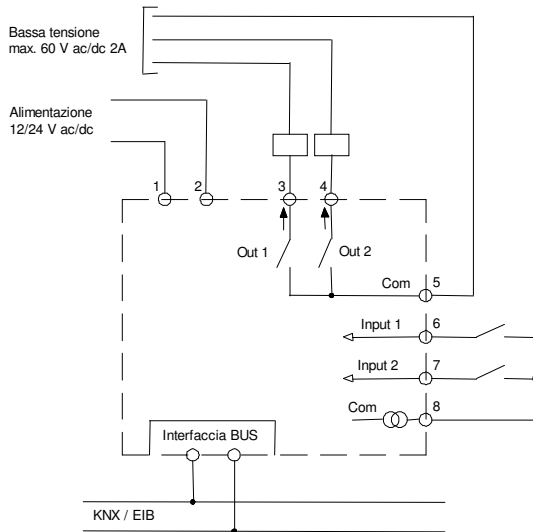

2.2 Operating and display elements

Front Side with glass frame cover

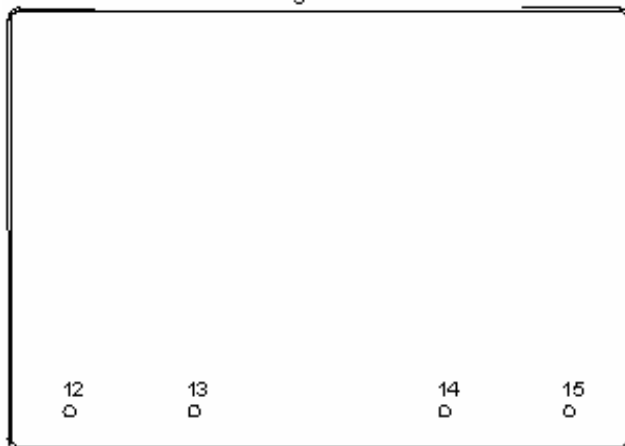

Connections:

- 1 Power Supply 12/24 Vcc/ac
- 2 Power Supply 12/24 Vcc/ac
- 3 OUT 1 terminal relay 1 (NO)
- 4 OUT2 terminal relay2 (NO)
- 5 COM Outputs
- 6 IN 1 (potential free)
- 7 IN 2 (potential free)
- 8 COM Inputs
- 11 Bus Connection Terminal:
 Black = bus polarity (-)
 Red = bus polarity (+)

Operating Elements:

- 9 Programming LED
- 10 Programming push button
- 12 Led 4
- 13 Led 3
- 14 Led 2
- 15 Led 1

2.3 Dimension drawing

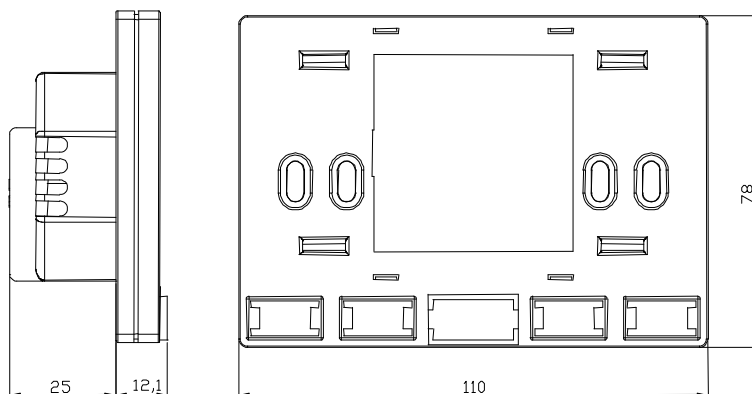

2.4 Mounting and wiring hints

The device may be used for permanent indoor installations in dry locations within wall boxes.

Requirements for installation

- The device must not be connected to 230V cables.
- The prevailing safety rules must be heeded.
- The device must be mounted and commissioned by an authorised installer.
- The applicable safety and accident prevention regulations must be observed.
- The device must not be opened. Any faulty devices should be returned to manufacturer.
- For planning and construction of electric installations, the relevant guidelines, regulations and standards of the respective country are to be considered.

Requirements for commissioning

- Connect each single KNX/EIB bus core inside the bus connection terminal block observing bus polarity .
- Slip the bus connection block into the guide slot placed on the front side of this device and press the block down to the stop.
- In order to commission the device, a PC with ETS2 version V1.3 or higher is required as well as an interface to the bus, e.g. via an RS232 interface or via a USB interface.
- The device configuration (KNX physical address assignment) is done by pressing the programming push button located on the front of the housing.

Supplied state

- The device is supplied with the physical address 15.15.255.
- It is therefore necessary to load parameters and group addresses during commissioning. However the complete application program can be reloaded if required.
- The bus connection terminal block is included in the package.
- The instruction sheet is included in the package.

Maintenance

- The device is maintenance free.
- In case of damage during transportation or storage, no repairs may be carried out by external staff.
- When the device is opened the right to claim under guarantee expires.

3. Product and functional overview

The **Transponder Reader - TR22A01KNX/TR22A11KNX** is an EIB/KNX wall mounting device suitable to access control application.

This device can be used in any kind of building (Hotel, Hospital, Offices, Parking, etc..) where the access control application is required.

The device is equipped with two binary inputs (potential free contacts) that can be used, for instance, to control whether the door lock has been opened or closed or other signals coming from external switches/contacts (i.e. windows, bathroom emergency alarms, etc..).

The transponder reader is equipped also with two output relays which can be used for any purposes, for instance in case of Hotel application to open the door or turning on the courtesy light inside the room.

The product provides on the front side four LEDs in order to enlighten 4 icons to display the following states (e.g. in case of Hotel management):

- Access Allowed/Not Allowed
- SOS request
- Service Call (clean room, etc..)
- Client status (“Busy room” or “Do not Disturb”)

The LEDs and icons can be configured in association with other alarms or events (see LEDs signalling in the “Application Notes” included).

The transponder reader can reads cards or keys at a maximum distance of 30mm from the front side.

The access control follows a sequence where the “Build Number” has been checked at first, then the expiration data, next the password ID for client/guest/service identification, then the enabled days of week and hours range. In case card reading pass all checks the door is opened, the courtesy light inside is switched on and a specific 1 bit object associated to the identified class of user is sent. At the same time the Transponder Reader sends the access response to the bus in order to be detected and stored by a visualization or management software..

The reader can identifies up to four types or classes of users through the reading of four different ranges of passwords written in the cards created with the “*Transponder Encoder*” (code: *TE00A01USB*).

This device provides also an alarm function by sending an “Alarm” object (1bit) to alarm, for instance, a centralized visualization software (e.g. “*eAccess*” or “*eHotel*”) that a power failure was occurred and then recovered next. This advice can be useful to visualization and monitoring software to update some configuration data to the readers and to the card holders or for other purposes.

The physical address, group address and parameters are assigned and programmed with the ETS tool software. In order to commission the device, a PC with ETS2 version V1.3 or higher is required as well as an interface to the bus, e.g. via an RS232 interface or via a USB interface.

This device must be configured and loaded with the following application program:

EEL_RDT1_10 Transponder Card Reader

With this application program the following functions can be parametrized and configured:

Application Program: EEL_RDT1_10 Transponder Card Reader

- Max number of group addresses: 35
- Max number of group address associations: 32

General Configurations	<ul style="list-style-type: none"> • <u>Single or Multiple (max 4) user groups identification</u> • <u>Grant date and grant days control enable</u> • <u>Power failure and recovery alarm enable</u>
Input 1 (and 2) Configuration	<ul style="list-style-type: none"> • <u>Switching states ON or OFF can be set depending on input pulse edge evaluation (rising or falling edge).</u> • <u>Cyclical sending option at adjustable intervals</u>
Relay 1 Configuration	<ul style="list-style-type: none"> • <u>“General Purpose” or “Door Open” function selection</u> • <u>Normally open or closed contact setting</u> • <u>Time switching (e.g.: “Door lock timing release”)</u>
Relay 2 Configuration	<ul style="list-style-type: none"> • <u>“General Purpose” or “Courtesy Light” function selection</u> • <u>Normally open or closed contact setting</u> • <u>Time switching (e.g.: “Courtesy light timeout”)</u>

Note: The default settings for the options are underlined (e.g. Options: no/yes)

4. Parameters

4.1 Parameter window “General Configurations”

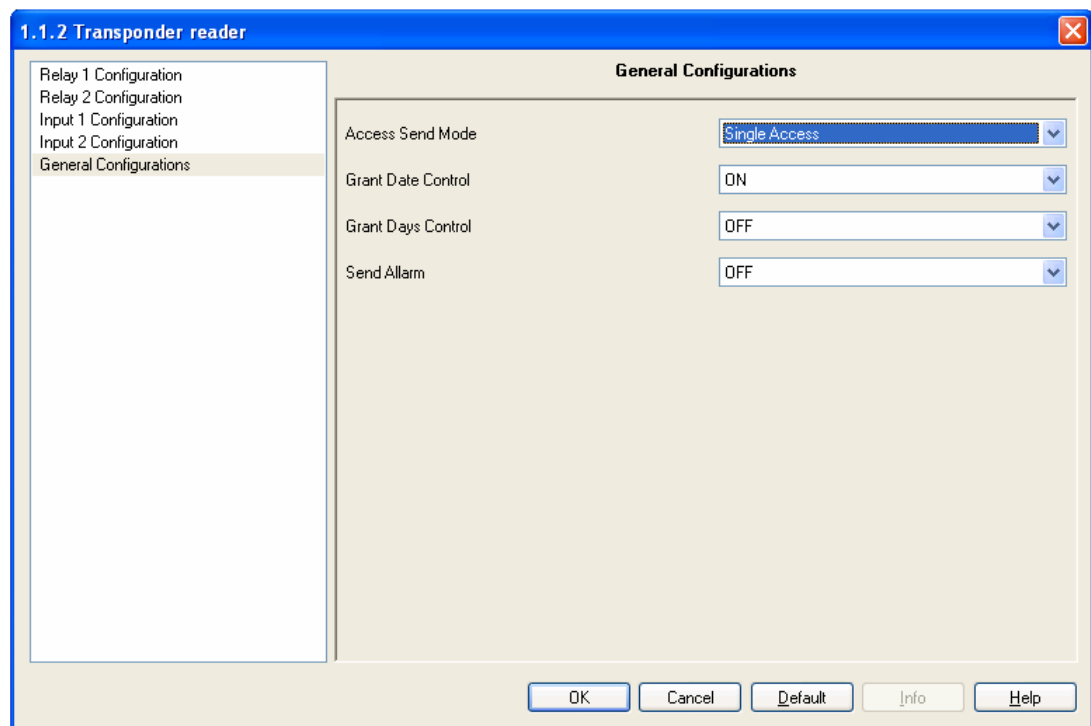

Fig. 1: Parameter Window “General Configurations”

- **Access Send Mode**

Options: Single Access
 Different Access

Option “*Single Access*”: enables the 1 bit object (“Valid Access”) that is sent to the bus in case a valid access has been identified by the reader. With this option only one single group of users are managed in the range of passwords admitted.

Option “*Different Access*”: enables four 1 bit objects (“Access 1”, ..., “Access 4”) corresponding to the reading and entrance allowed of users whose password belongs to one of four pre-defined range of passwords.

As a password is identified as belonging to one of these four classes, than the object “Access X” is sent to the bus.

This feature allows the identification of users within these 4 classes (e.g. clients, staff, maintenance service, emergency, etc..).

- **Grant Date Control**

Options: $\frac{ON}{OFF}$

Option “ON”: enables expiration date control during transponder card or key reading.

Option “OFF”: disables expiration date control

- **Grant Days Control**

Options: $\frac{OFF}{ON}$

Option “OFF”: the days of week allowed for entrance are not checked.

Option “ON”: enables the days of week control.

Note: in both cases the transponder reader always reads and checks the timing hour valid range associated to the card.

- **Send Alarm**

Options: $\frac{OFF}{ON}$

Option “OFF”: the device does not send the object “Alarm”

Option “ON”: the device sends the object “Alarm” in case of power failure after the power supply has been recovered.

Note: this feature is useful to visualization software in order to re-send data to the readers after a power failure in order to re-synchronize data and time with the central unit (pc) or for any other purposes.

4.2 Parameter Window “Relay 1 Configuration”

The Relay 1 configuration parameters are shown in the next window:

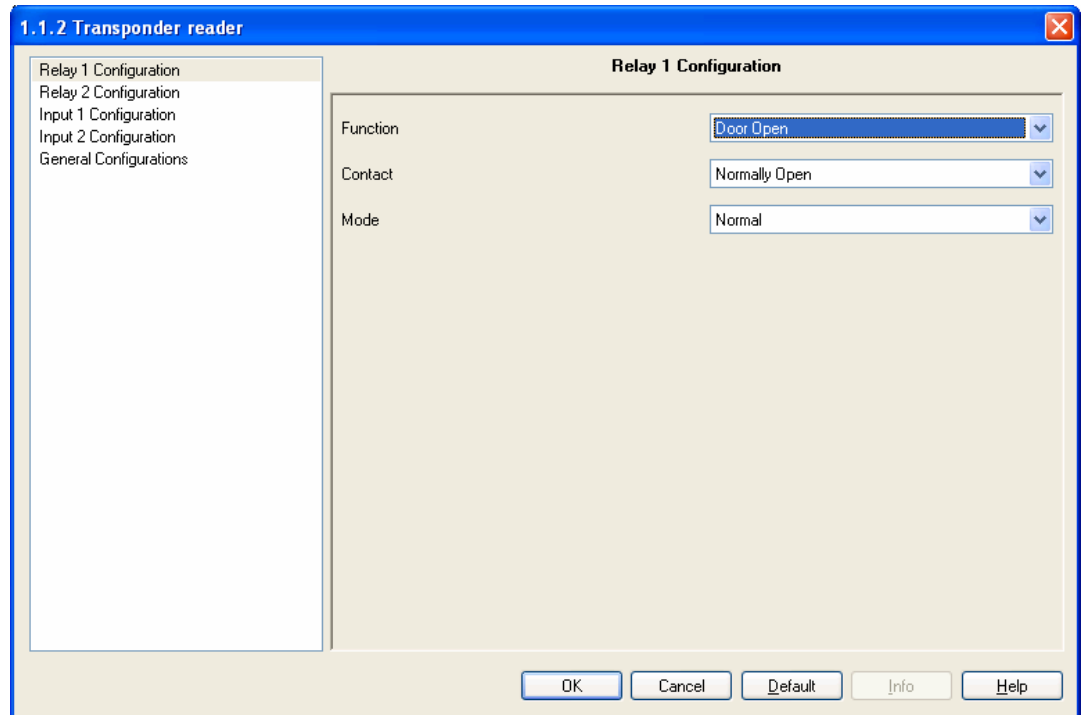

Fig. 2: Parameter Window “Relay1 Configuration”

- **Function**

Options: General Purpose
 Door Open

Option “*General Purpose*”: Relay 1 is controlled only by the “Relay 1” (1 bit) communication object as normal independent binary output channel.

Option “*Door Open*”: the Relay 1 is switched (ON or OFF depending on option selected in the next parameter “Contact”) if a valid transponder card is read or via the “Door Unlock” (1 bit) communication object.

- **Contact**

Options: Normally Open
 Normally Close

Option “*Normally Opened*”:
 Off telegram = contact open
 On telegram = contact closed.

- Option “*Normally Closed*”:
 Off telegram = contact closed
 On telegram = contact open.

- **Mode**

Option: Normal
Timing

Option “Normal” : the Relay1 will be switched ON by sending an ON command and will be switched OFF by sending an OFF command within the associated object “Relay 1”.

The status of the relay contact can be inverted by parameter setting “Contact”: Normally Close”.

Option “Timing”: enable the time switch function (e.g. electrical lock control). See next.

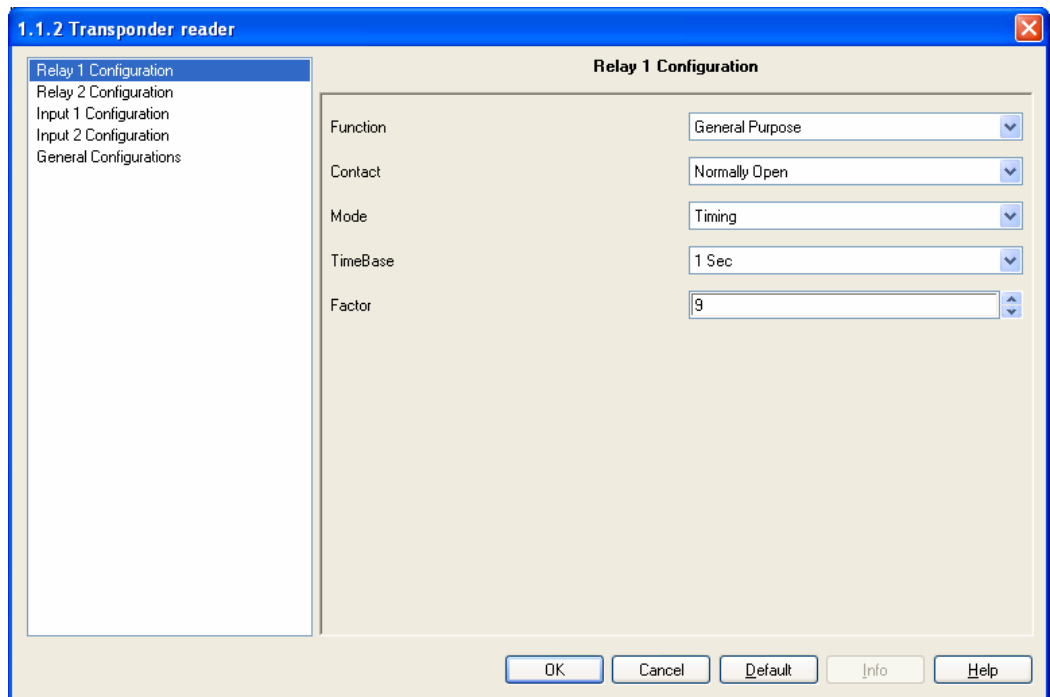

Fig. 3: Parameter Window “Relay 1 Configuration” with Mode = “Timing”.

When an On telegram is received via the output object, it is routed directly to the relay. The Off delay that has been assigned starts at the same time. Every further “1” (ON) that is received before the timer has elapsed, resets the delay and restarts it. Once the period has elapsed, a “0” is passed to the output. An Off telegram deletes the Off delay and is immediately routed to the output.

The time for the Off delay is set here. This is calculated from the selected base “TimeBase” multiplied by the factor “Factor” that is entered here:

$$T_{ON} = \text{TimeBase} \times \text{Factor}$$

Note: An attempt should always be made to set the required time with the smallest possible base as the base that is selected here also simultaneously specifies the maximum timing error.

- **TimeBase**

Options: 250ms, 500ms, 1Sec, 1Min, 1Hour

- **Factor**

Options: 0...10...255

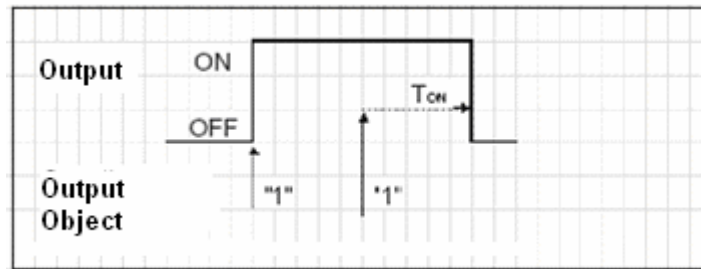

Fig. 4: Timing Mode (e.g. for electrical lock pulse operating control).

4.3 Parameter Window “Relay 2 Configuration”

Relay 2 differs from Relay 1 only for the first parameter setting “Function”.

The Relay 2 configuration parameters are shown in the next window:

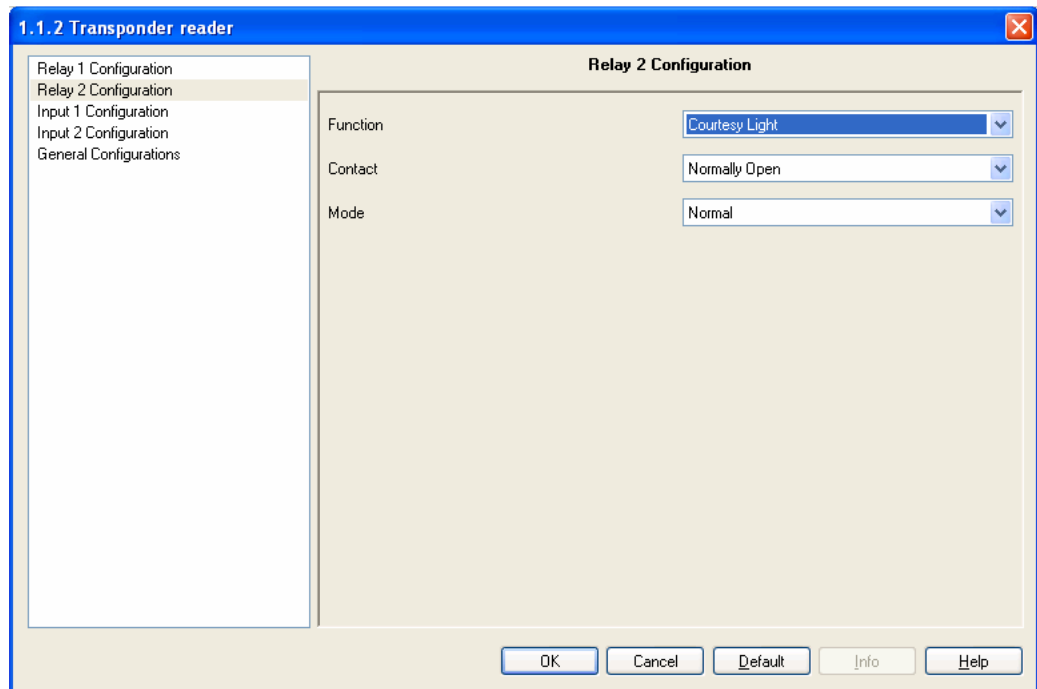

Fig. 5: Parameter Window “Relay 2 Configuration”

- **Function**

Opzioni: General Purpose
Courtesy Light

Option “*General Purpose*”: Relay 2 is controlled only by the “Relay 2” (1 bit) communication object as normal independent binary output channel.

Option “*Courtesy Light*”: the Relay 2 is switched (ON or OFF depending on option selected in the next parameter “Contact”) if a valid transponder card is read or via the “Courtesy Light” (1 bit) communication object.

All the other parameters are completely similar to “Relay 1 Configuration” settings, so please see functional descriptions in par. 4.2.

Note: please see *Outputs timing diagrams* in “Application Notes”.

4.4 Parameter Window “Input 1 Configuration”

Parameters associated to Input1 channel are the same as ones associated to Input 2.

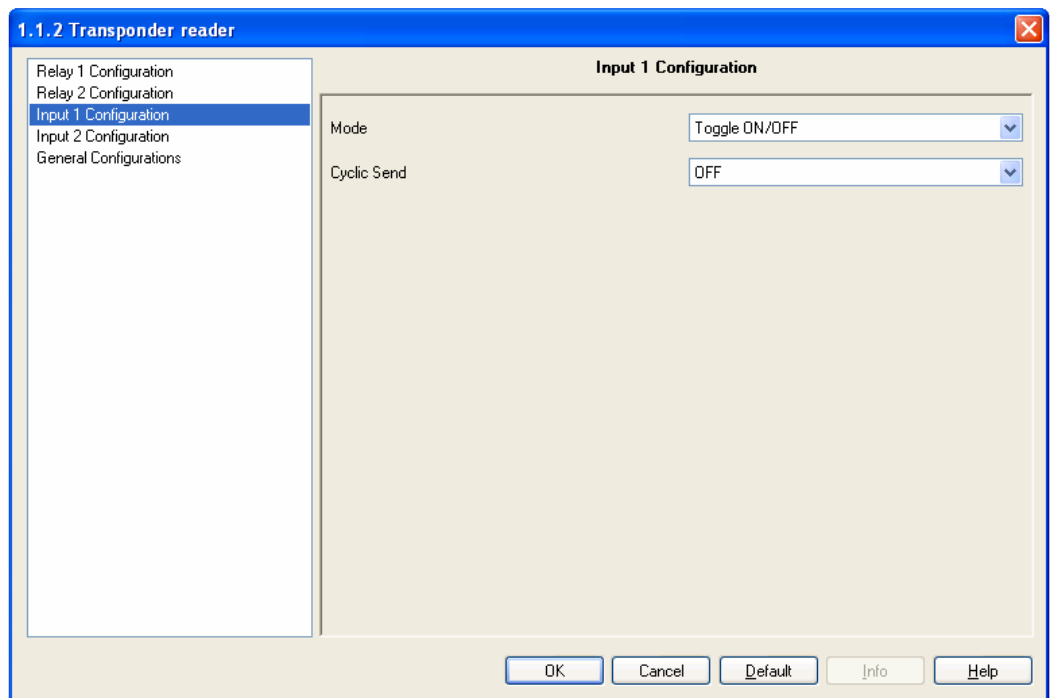

Fig. 6: Parameter Window “Input 1 Configuration”

Mode

Options:

Rising ON
Rising OFF
Falling ON
Falling OFF
Rising ON / Falling OFF
Rising OFF / Falling ON
Toggle ON/OFF
Toggle OFF/ON

With this parameter we can program which status we need to send to the bus (ON/OFF; TOGGLE) when a rising or falling edge is detected in the input signal.

Behaviour:

“Rising On”: A rising edge causes a logic “1” to be transferred to the communication object. A falling edge does not alter the object value.

“Rising Off”: A rising edge causes a logic “0” to be transferred to the communication object. A falling edge does not alter the object value.

“Falling On”: A falling edge causes a logic “1” to be transferred to the communication object. A rising edge does not alter the object value.

“Falling Off”: A falling edge causes a logic “0” to be sent to the communication object. A rising edge does not alter the object value.

“Rising On, Falling Off”: A rising edge causes a logic “1” to be transferred to the communication object. A falling edge causes a logic “0” to be sent.

“Rising Off, Falling On”: A rising edge causes a logic “0” to be transferred to the communication object. A falling edge causes a logic “1” to be sent.

“Toggle ON/OFF”: Each rising edge causes the object value to be inverted. This means that a logic “1” is sent to the communication object after the first rising edge. The next one sends a logic “0” and so on. A falling edge does not alter the object value.

“Toggle OFF/ON”: Each falling edge causes the object value to be inverted. This means that a logic “1” is transferred to the communication object after the first falling edge. The next one sends a logic “0” and so on. A rising edge does not alter the object value.

Cyclic Send

Options: *ON*
 OFF

This parameter enables the cyclical sending of current value of Input1 to the bus at a set interval.

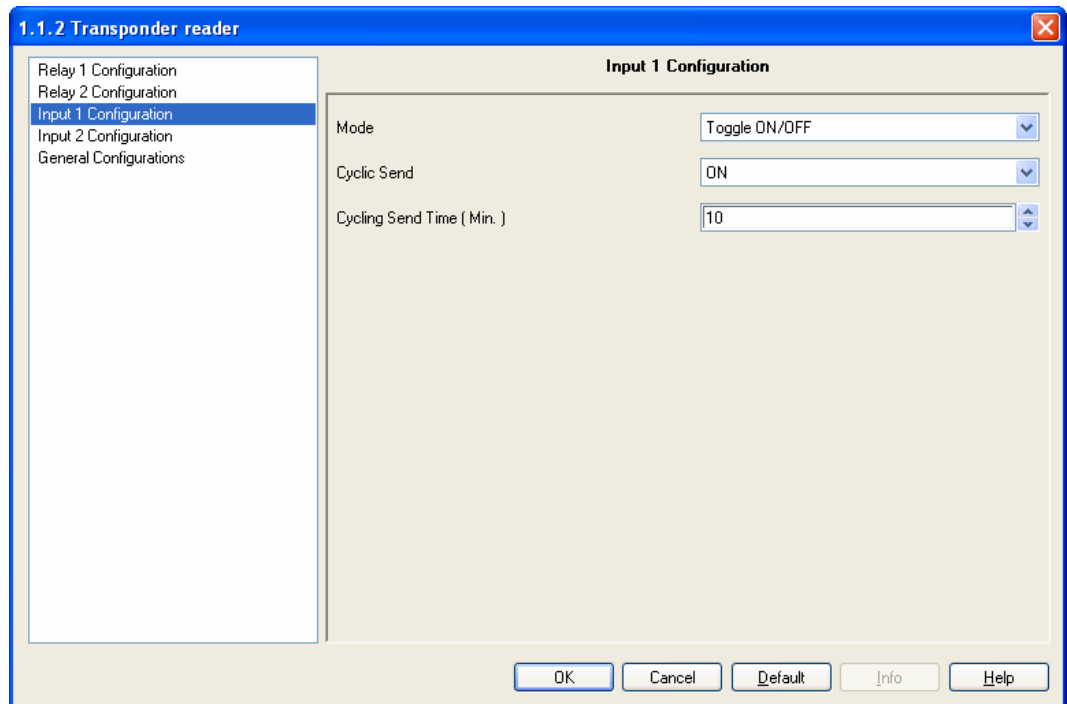

Fig. 7: Parameter Window “Input 1 Configuration” with Cyclic Send enabled (ON).

- **Cycling Send Time (Min)**

Options: 1...10...255

The cyclic time for sending telegrams repeatedly on the bus with Input1 current value is specified here.
The time units are minutes.

Note: please see Inputs timing diagrams in “Appication Notes”.

5 Communication Objects

The EIB/KNX communication objects provided within the application program “EEL_RDT1_10 Transponder Card Reader” are shown next:

Number	Name	Object Func...	Des...	Length	C	R	W	T	U
0	Door Unlock	On/Off		1 bit	C	R	W	T	-
1	Relay 2	On/Off		1 bit	C	R	W	T	-
2	Led 2	On/Off		1 bit	C	R	W	T	-
3	Led 2 Blink	Blink/Off		1 bit	C	R	W	T	-
4	Led 3	On/Off		1 bit	C	R	W	T	-
5	Led 3 Blink	Blink/Off		1 bit	C	R	W	T	-
6	Led 4	On/Off		1 bit	C	R	W	T	-
7	Led 4 Blink	Blink/Off		1 bit	C	R	W	T	-
8	Date	Set Data		3 Byte	C	R	W	T	-
9	Time	Set Time		3 Byte	C	R	W	T	-
10	Build Number	Set Plant ID		2 Byte	C	-	W	T	-
11	Guest Data	Password		10 Byte	C	-	W	T	-
12	Access Code	Access Data		4 Byte	C	-	-	T	-
13	Access 1	Enable		1 bit	C	R	-	T	-
14	Access 2	Enable		1 bit	C	R	-	T	-
15	Access 3	Enable		1 bit	C	R	-	T	-
16	Access 4	Enable		1 bit	C	R	-	T	-
18	Input 1	On/Off/Toggle		1 bit	C	R	-	T	-
19	Input 2	On/Off/Toggle		1 bit	C	R	-	T	-
20	Allarm	On		1 bit	C	R	-	T	-

Fig. 8: Communication Objects (some objects are visible if enabled by specific parameter setting).

Nr.	Function	Name	Type	Flag
0	On/Off	Relay 1 / Door Unlock	EIS1, 1bit DPT 1.001	C,R,W,T
<p>This object is received from the bus to control the output relay 1. In case the “Door Open” function is enabled this object is named “Door Unlock” and the relay 1 is switched also in case of valid transponder card reading and consequent entrance acknowledge (for this usage the relay1 should be connected to a door lock). In case the output relay is set as “Normally Open” contact the relay is closed when value “1” is received and it is opened in case of value “0” (vice versa in case of “Normally Closed” contact). If Timing Mode is enabled when an On telegram is received via the Output object (“Relay “1 or “Door Unlock”), it is routed directly to the relay 1. The Off delay that has been assigned starts at the same time. Every further “1” (ON) that is received before the timer has elapsed, resets the delay and restarts it. Once the period has elapsed, a “0” is passed to the output. An Off telegram deletes the Off delay and is immediately routed to the output.</p>				

Nr.	Funzione	Nome	Tipo	Flag
1	On/Off	Relay2 / Courtesy Light	EIS1, 1bit DPT 1.001	C,R,W,T
<p>This object is received from the bus to control the output relay 2.</p> <p>In case the "Courtesy Light" function is enabled this object is named "Courtesy Light" and controls the relay 2 to be switched ON/OFF. Relay 2 is also switched ON/OFF in case of valid transponder card reading and consequent entrance acknowledge (for this usage the relay2 should be connected to the courtesy light).</p> <p>In case the output relay is set as "Normally Open" contact the relay is closed when value "1" is received and it is opened in case of value "0" (vice versa in case of "Normally Closed" contact).</p> <p>If Timing Mode is enabled when an On telegram is received via the Output object ("Relay "1" or "Courtesy Light"), it is routed directly to the relay 2. The Off delay that has been assigned starts at the same time. Every further "1" (ON) that is received before the timer has elapsed, resets the delay and restarts it. Once the period has elapsed, a "0" is passed to the output. An Off telegram deletes the Off delay and is immediately routed to the output.</p>				
2,4,6	On/Off	LedX	EIS1, 1bit DPT 1.001	C,R,W,T
<p>The object LedX is used to control via bus the Ledx placed on the front of the housing.</p> <p>In case a switching "ON" is received with this object the LedX is switched ON continuously until a switching "OFF" signal is received.</p> <p>This command has priority on the object "LedX Blink".</p> <p>For a LEDs signalling example please see "Application Notes" at par. 6.</p>				
3,5,7	Blink/Off	LedX Blink	EIS1, 1bit DPT 1.001	C,R,W,T
<p>It receives from the bus an activation or deactivation blinking command for the LedX.</p> <p>The LedX blinks with a timing period of 0,5 sec.</p> <p>For a LEDs signalling example please see "Application Notes" at par. 6.</p>				
8	Set Date	Date	EIS4, 3byte DPT 11.001	C,R,W,T
<p>The Date object value is used to synchronize the transponder reader with a visualization software and to verify the access qualification of a valid card.</p> <p>In the device and on the card the date is in dd,mm,yy format where "yy" is a number from 90 to 89 and corresponds to the years from 1990 to 2089.</p> <p>The updating is normally done via bus at least one time a day and each time that the supervision centre receives an "Alarm" signal (i.e. after a power failure).</p>				
9	Set Time	Time	EIS3, 3byte DPT 10.001	C,R,W,T
<p>The Time object value is used to verify the access qualification of a valid card and to control the timing hour valid range.</p> <p>The updating is done normally via bus at least one time a day and each time that the supervision software (e.g. "eHotel" or "eAccess") receives an "Alarm" signal (i.e. after a power failure).</p>				

Nr.	Funzione	Nome	Tipo	Flag
10	Set Plant ID	Build Number	EIS10, 2byte DPT 7.001	C,W,T
<p>The object "Build Number" is used to identify the installation or the building where the transponder readers are installed.</p> <p>This code avoid any possible risk of using the same card for entrance in two different buildings. It is sent by the building management software during commissioning.</p>				
11	Password	Guest Data	NON EIS 10 byte	C,W,T
<p>The object "Guest Data" is sent by the access control management software to the transponder readers and holders in order to enable entrance and card identification once the transponder card is read.</p> <p>This object (non KNX standard object) contains the user password id, the expiration date, the enabled timing entrance ranges, the valid entrance days of week and the expiration data. After the "Build Number" reading and acceptance the transponder reader or holder controls the password and any other information associated in order to allow or not allow the room entrance.</p> <p>"Guest Data" object is normally sent during transponder readers and holders configuration by the access control software ("eAccess" or "eHotel").</p>				
12	Access Data	Access Code	EIS12, 4byte DPT 15.000	C,T
<p>This object is used to send to the bus the result of a transponder card reading. Within this object the password and some reading feedbacks are sent to the centralized access control software (e.g. "eHotel" or "eAccess") to be managed or stored.</p>				
13..16	Enable Access	Access X	EIS1, 1bit DPT 1.003	C,R,T
<p>If "Access Send Mode" has been set to "Different Access" than the four (1 bit) switching objects "Access1"... "Access 4" are visualized.</p> <p>This object is sent only after a card reading acknowledge and entrance allowed. Depending on which type or class of user has been detected during a card reading the object "Access X" is sent.</p> <p>At the same time the device sends also the object "Access Code" with the accepted password and other access control info about card reading results.</p> <p>In case "Access Send Mode" parameter is set to "Single Access" these objects are not enabled but only the unique "Valid Access" object next is used.</p>				
17	Enable Access	Valid Access	EIS1, 1bit DPT 1.003	C,R,T
<p>This object is sent only after a card reading acknowledges and entrance allowed. If "Access Send Mode" has been set to "Single Access" than only the 1 bit switching object "Valid Access" is used to advice that the entrance has been accepted.</p> <p>At the same time the device sends also the object "Access Code" with the accepted password and other access control info about card reading results.</p>				

6 Application Notes

Examples of timing diagrams for Inputs

1. Configured with edge evaluation: "rising On"



6. Configured with edge evaluation: "rising Off, falling On"

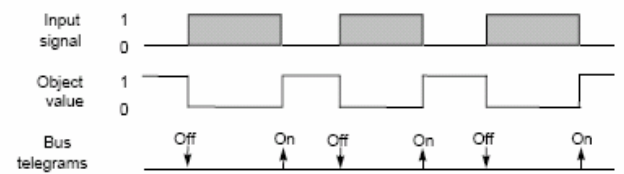

2. Configured with edge evaluation: "rising Off"

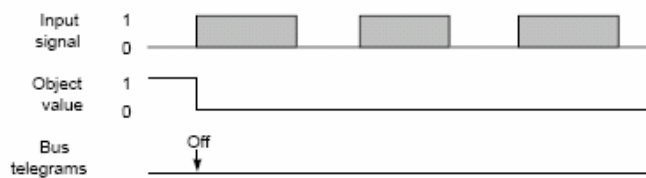

7. Configured with edge evaluation: "Toggle On Off"

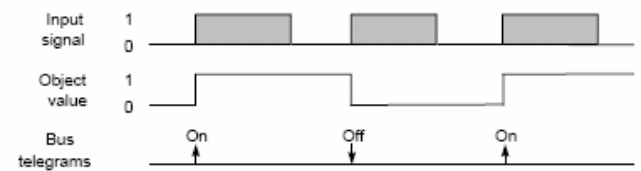

3. Configured with edge evaluation: "falling On"

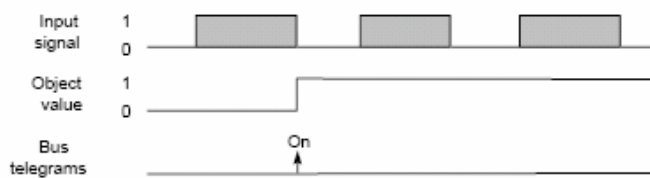

8. Configured with edge evaluation: "Toggle Off/On"

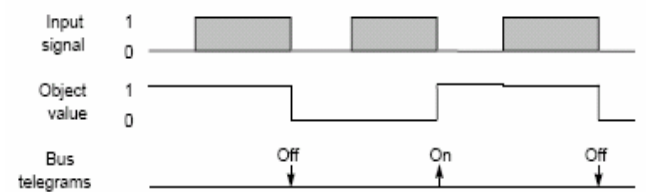

4. Configured with edge evaluation: "falling Off"

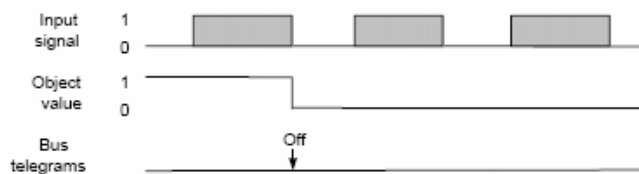

5. Configured with edge evaluation: "rising On, falling Off"

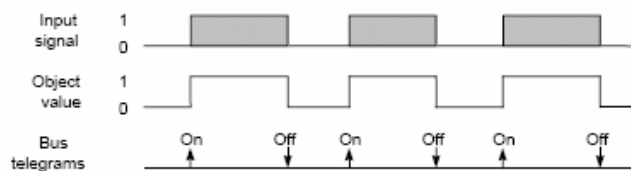

Examples of timing diagrams for Outputs

1. Switching

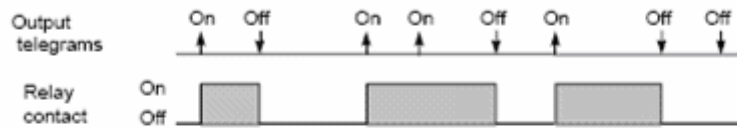

2. Switching with a time switch function

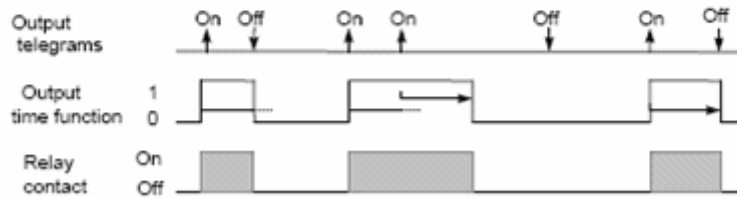

LEDs signalling: Hotel room management application notes

The four LEDs placed on the front of the cabinet are used to enlighten the corresponding four icons in order to signal and advice transponder card reading feedbacks and some different alarms or user calls coming from the room.

The first LED1 (red/green) is used only for transponder card or key reading feedbacks. This functions are fixed and not configurable by planners or users.

The other 3 LEDs can be freely associated, through group addresses associations, to different kind of alarms or signals coming from the room inside and received from other KNX input components such as push buttons or sensors.

Next follow a typical Hotel room management usage of such LEDs.

Application Example: LEDs signalling in Hotel Room Management

- LED1 red/green = “access control”. The LED1 is normally OFF. When is ON can assume the following display functions:
 - Fixed Green light for 3 sec.: Entrance Allowed (door open command is sent to the bus and/or the relay1 and 2 are activated)
 - Red blinking for 3 sec.: Reading Error (unreadable card or wrong card reading). No entrance is allowed.
 - Fixed Red light for 3 sec.: Entrance Not Allowed (“Build Number” or “Password” or “Grant Date” (if control enabled with parameter) or “Grant Days” (if control enabled with parameter) not valid;
 - Blinking Green Light for 3 sec.: Entrance Not Allowed (access time does not match with timing hours ranges associated to the password);
 - Red and Green LEDs blinking: after an ETS configuration download or after power supply.

The signalling functions, with a fixed or blinking light, associated to the next LEDs (LED2, LED3, LED4) can be configured freely by ETS using the corresponding group objects. In case of Hotel room management, for instance, they can be used associated to push buttons as follows:

- LED2 red = “SOS alarm” or any other alarm;
- LED3 amber = “Room busy”, “Do not Disturb” or any other alarm;
- LED4 green = “Room Service Call” or any other alarm;

- Any information inside this manual can be changed without advice.
- This handbook can be download freely from the website: www.eelectron.com
- **Exclusion of liability:**
Despite checking that the contents of this document match the hardware and software, deviations cannot be completely excluded. We therefore cannot accept any liability for this. Any necessary corrections will be incorporated into new versions of the manual.