



b.a.b-technologie gmbh

KNXeasy Gateway Dokumentation

Datum: 21. February 2012

DE



b.a.b – technologie gmbh

im INHOUSE Dortmund
Rosemeyerstr. 14
44139 Dortmund

info@bab-tec.de

Tel.: +49 (0) 231 – 476 425 - 30
Fax.: +49 (0) 231 – 476 425 - 59
www.bab-tec.de



INHALTSVERZEICHNIS

1	Application	5
2	The KNXeasy Protocoll	6
3	Prepare ESF Data.....	8
4	Configuration	10
4.1	Network parameter	10
4.2	KNXeasy Gateway.....	11
	ESF+	11
	KNXeasy to MySQL	11
4.3	System.....	13
5	KNXeasy Monitor	14
6	KNXeasy Function	15
6.1	KNXnet/IP to KNXeasy.....	15
6.2	KNXeasy to KNXnet/IP.....	15
6.3	KNXeasy Status Requests.....	15
7	Configuration tool for the KNXeasy gateway.....	16
7.1	Configuration Page network Parameter.....	17
7.2	KNXeasy Configuration.....	18
7.2.1	System.....	19
7.3	Updatefunction	20
7.4	Datamanagement	22
7.4.1	Import von esf Dateien	23
	ESF Import	24
7.4.2	Editing EIB group addresses	24
7.4.3	EIS Typen.....	25
7.4.4	Saving data as sam file	26
7.4.5	Export of esf+ files.....	26
7.4.6	Perspectives and Views	28
7.4.7	Views - Hex Converter	29
7.4.8	Views - Device Overview.....	30
7.4.9	Views - Device Details	31
7.4.10	Views - KNXeasy Monitor.....	31
8	FAQ.....	33



Abbildungsverzeichnis

Figure 1 KNXeasy connecteda.....	5
Figure 2 ESF Import.....	8
Figure 3 Simple Adress Manager.....	8
Figure 4 Network Parameter.....	10
Figure 5 KNXeasy Configuration.....	11
Figure 6 System.....	13
Figure 7 KNXeasy Monitor.....	14
figure 8 b.a.b-technologie Manager.....	16
figure 9 Connetion Dialog.....	16
figure 10 Network Parameter.....	17
figure 11: KNXeasy Configuration.....	18
figure 12 Eingabefenster.....	18
figure 13 System.....	19
figure 14 Update.....	20
figure 15 Install.....	21
figure 16 datamanagement.....	22
figure 17 Import.....	23
figure 18 ESF Import esf.....	24
figure 19 ESF.....	25
figure 20 Save Data.....	26
figure 21 ESF Export.....	27
figure 22 ESF Export.....	28
figure 23 Views Hex Converter.....	29
figure 24 Views Device Overview.....	30
figure 25 Views Device Details.....	31
figure 25 Views KNXeasy-monitor.....	32



1 APPLICATION

KNXeasy is connected to your local area network via ethernet. It translates the binary KNXnet / IP bidirectional into a simple ASCII protocol. Internally, the device uses an address-state table as a snapshot KNX installation. For later analysis, the the KNX telegrams can be stored into a MySQL database. For configuration only the free of charge b.a.b-technologie manager software is needed.

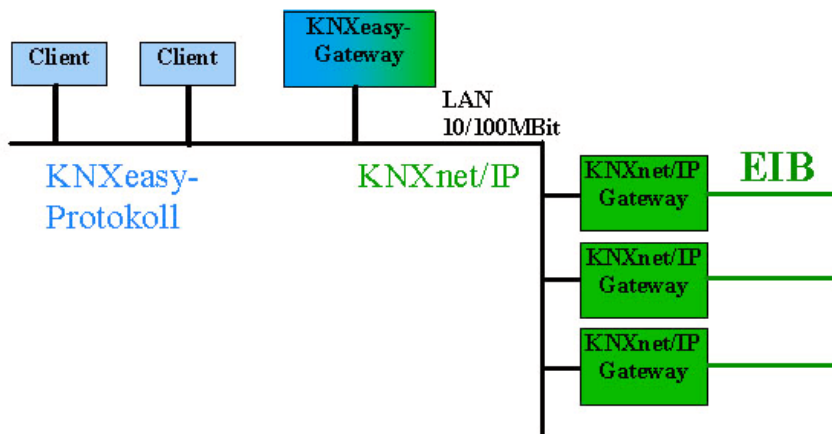

Figure 1 KNXeasy connecteda

Specifications

Montage top hat rail

Connectors DC-IN (10-30 V), RJ-45(10 Mbit Ethernet)

Nominal current 70mA

Max. current 180mA (Bootvorgang)



2 THE KNXEASY PROTOCOLL

The KNXeasy protocol is a very simple ISO-8859-1 encoded ASCII protocol.

Command Structure

Each parameter is divided by space characters and may not contain whitespaces itself.

A B D E F

A: Source- / Targetdescriptor

B: SystemID

C: Command

D: Groupaddress

E: EIS-Type

F: Data

Source- / Targetdescriptor

Defines the source or target protocol. When a telegram is received in the KNXeasy protocol, this descriptor defines into which protocol the telegram will be translated. On the other way it defines the original protocol in which this telegram has been received.

Values:

- KNXnet/IP

SystemID

SystemID of the KNXnet/IP installation. In KNXnet/IP there can be 0 to 255 different system identifiers. for other applications values of 0 to 65535 are possible.

Command

The action which will be or has been executed.

Values:

- write KNXeasy -> KNXnet/IP: The given value (data) will be sent on the bus.
- KNXnet/IP -> KNXeasy: The value has been sent on the bus..
- read Request the current value of a group address. The answer will be generated using the internal address status table.
- status The answer to a read request which will only be sent to the requesting client.
- **Groupaddresses**
- The groupaddresses (destination address) can be used in two or three layer format.
- Three layer:
 - main group/middle group/sub group
- Two layer:
 - main group/sub group
- Comment:
- The groupaddresses are packed in an array of two bytes. The format just specifies the presentation of these two bytes. In both formats, the most significant bit differs the physical addressing from the group addressing.
- For three layer format, the following 4 bit are used for the main group (b, range 0 - 15). 3 bit are reserved for the middle group (c, range 0 - 7) and the lowest 8 bit defines the sub group (d, 0 - 255).
 - abbb bccc dddd dddd
- The two layer format just combine the middle and sub group as the 2 layer sub group with 11 bit length (c, range 0-2047). The main group still remains as 4 bit (b, range 0-15).
 - abbb bccc cccc cccc
- **Timestamp**



- The answer to a status read command contains a timestamp to compare the telegrams to each other:
- yyyy/mm/dd HH:MM:SS
- y = year; m = month; d = day; H = hour; M = minute; S = second

EIS-Typ und Daten

EIS_1	on off 1 0
EIS_2	on off 1 0 brightenX dimX (X = dimming level)
EIS_3	day: Mon Tue Wed Thu Fri Sat Sun or Mo Di Mi Do Fr Sa So time: hour:minute:second
EIS_4	day.month.year
EIS_5	x.y (z.B. 15.3; 2 Byte floating point))
EIS_6	x%
EIS_7	up down
EIS_8	on off disabled enabled
EIS_9	x.y (z.B. 15.3; 4 Byte floating point)
EIS_10u	x = 0 .. 65535
EIS_10s	x = -32768 .. 32767
EIS_11u	x = 0 .. 4294967295
EIS_11s	x = -2147483648 .. 2147483647
EIS_12	Not supported!!
EIS_13	a – z A – Z
EIS_14u	x = 0 .. 255
EIS_14s	X = -128 .. 127
EIS_15	“abcdefghijklmn” (max 14 Zeichen)
EIS_UNDEF	When a telegram is received from KNXnet/IP, KNXeasy tries to look up the groupaddress in the ESF+ data. If the groupaddress is not configured in the ESF+ file, KNXeasy sends the raw data of the telegram with EIS-type EIS_UNDEF each byte prefixed with 0x. KNXnet/IP 0 write 2/257 EIS_UNDEF 0x19 0x29

Examples:

KNXnet/IP 0 write 3/1/4 EIS_1 off

KNXnet/IP 0 write 3/2/4 EIS_15 „Lunchtime“

KNXnet/IP 0 read 1/1

KNXnet/IP 0 status 1/1 2008/04/09 10:18:00 EIS_5 12.80

3 PREPARE ESF DATA

Since KNXnet/IP telegrams do not contain any information about the data, KNXeasY needs a table in which groupaddresses are linked to EIS-types. Using this table the KNXeasY knows how to convert the data of the telegrams into human readable values. This information gets stored into a so-called ESF+ file.

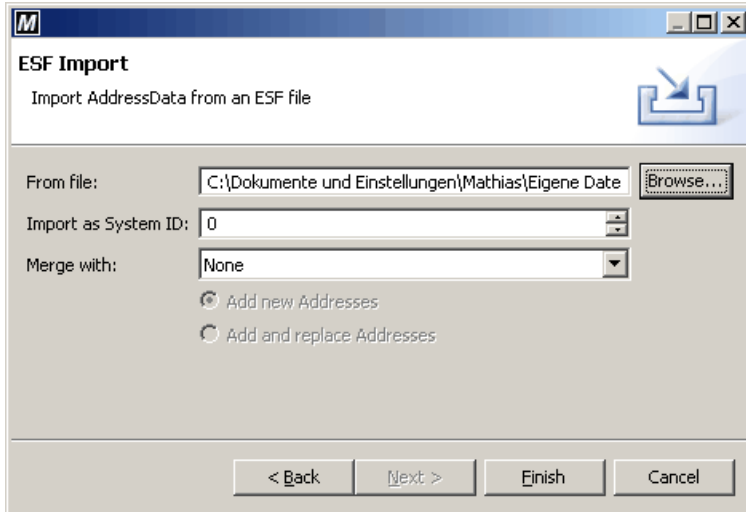

Figure 2 ESF Import

In the EIB programming software ETS you can export an ESF-file with the OPC export function. In this file all configured groupaddresses are listed and you can import this file into the manager. Go to the file -> import function and you will see the above window.

You have to select a system id for the selected ESF file for clear identification of the KNX installation (default 0). With the merge-option you can integrate this file into an already opened ESF editor. If the ETS project will be changed, you can add those changes to the ESF+ file using the merge function. If you click finish, the editor will be opened with a tree structure of the project data.

Most important is the column EIS type. Here you have to assign the correct EIS types to the group addresses. You can change the value by clicking into the EIS type field or by selecting one or more rows and using the popup menu with a rightclick. When all grouaddresses are configured correctly export the data into a ESF+ file.

Name	Address	Anzahl	EIS
Demotafel Unna rechts_1(2)	System ID: 0	15	
Schalten/Dimmen rechts	EIB Maingroup 10	5	
Neue Mittelgruppe	Middlegroup: 0	5	
Schalten 6152 Leuchte 1 rechts	10/0/1		EIS 1 (1 Bit On/Off)
Schalten 6152 Leuchte 2 rechts	10/0/2		EIS 1 (1 Bit On/Off)
Schalten 6155	10/0/3		EIS 1 (1 Bit On/Off)
Dimmen 6155	10/0/4		Undefined
Wert 6155	10/0/5		Undefined
Jalousie rechts	EIB Maingroup 11	2	
Neue Mittelgruppe	Middlegroup: 0	2	
auf/ab	11/0/1		EIS 1 (1 Bit On/Off)
stop	11/0/2		EIS 1 (1 Bit On/Off)
Heizung rechts	EIB Maingroup 12	6	
Leistung	EIB Maingroup 13	2	

Figure 3 Simple Adress Manager



Additionally to the ESF+ file you should save the editor into a .sam file. This file is used for later changes to the project data.

4 CONFIGURATION

To configure the KNXeasY you need the Manager software. Open the connection dialog in the menu Configuration -> KNXeasY.

The delivery status of KNXeasY is IP address 192.168.1.2 and SSH port 22.

If all necessary changes were made, the configuration can be saved using the save button in the upper right corner of the editor window.

4.1 NETWORK PARAMETER

To integrate KNXeasY into your network you might need to change the network parameters.

Network Parameters

Network Interface
Configure the settings for the network interface.

DHCP

IP-Address

Netmask

Gateway

DNS Server #1

DNS Server #2

DNS Server #3

Advanced Network Settings
Configure advanced network parameters

SSH Port

Network Parameters | KNXeasY Configuration | System

Figure 4 Network Parameter

Here you can configure the following parameters:

Network Interface

DHCP With the Dynamich Host Configuration Protocol (DHCP) the network parameters will automatically be configured by a DHCP server. If you check this box all other fields will be deactivated. You should not enable this function if there is no DHCP server in your network.

IP address The IP address of the KNXeasY. (Default 192.168.1.2)

Netmask Subnet mask which identifies the Network in combination with the ip address. (Default 255.255.255.0)

Gateway The gateway which can be used for broadcast messages or a database connection. The gateway must be reachable for the current IP address and subnet configuration.

DNS server You can define three DNS server. These will be used to resolv hostnames e.g. for the database connection.

Additional Settings

SSH port This is the port of the internal SSH server for configuration and maintenance purposes.



4.2 KNXEASY GATEWAY

- Loglevel The loglevel is used for maintenance purposes and should not be changed. This will decrease overall performance of KNXeasY.

- Network interface The internal network interface to use for KNXnet/IP and KNXeasY protocol

- Broadcast Adresse This address can be a broadcast or unicast address. KNXeasY messages will be sent to this address via UDP. If you change the IP address or subnet mask of your device, it might be necessary to adapt the broadcast address, too. If you are not sure which address to use, try out 255.255.255.255. Then KNXeasY will send messages to every available network

- Broadcast Port This port will be used for sending and receiving KNXeasY messages. (Default 4950)

- KNX installations KNXeasY can handle multiple KNX installations. Each installation is identified with the SystemID in the KNXeasY protocol and the multicast address and port for the KNXnet/IP protocol. Additionally the KNXeasY has a physical source address for each KNX installation.

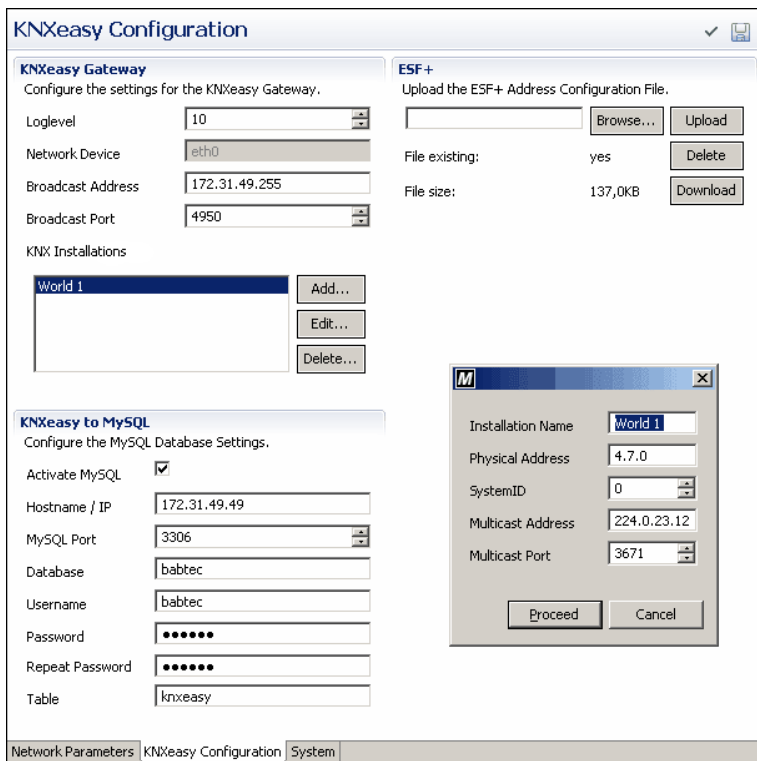

Figure 5 KNXeasY Configuration

ESF+

In this section you can upload delete or download the ESF+ file.

KNXeasY to MySQL

The KNXeasY offers the possibility to store all telegrams in a MySQL database for later analysis and evaluation. This MySQL Server can be used in the local network as well as on the Internet (Gateway and DNS must be correct).

In the database the plain text of the KNXeasY protocol is stored. In addition to this, the timestamp of the KNXeasY as well as from the database server is saved for each dataset.



Activate MySQL

The IP address or hostname of the MySQL server. If you use an external server, the gateway and DNS settings must be correct.

Hostname / IP

The IP address or hostname of the MySQL server. If you use an external server, the gateway and DNS settings must be correct.

Database The name of the database to use for KNXeasy data.

Username The username for this database.

Password The password for this database

Table The name of the table which will be used to store KNXeasy data.

This is the create-statement for the KNXeasy table in a database called 'babtec':

```

CREATE TABLE `babtec`.`knxeasy` (
  `id` int(11) NOT NULL auto_increment,
  `source_protocol` varchar(20) NOT NULL,
  `sernr` varchar(12) NOT NULL,
  `timestamp` varchar(50) NOT NULL,
  `source` varchar(10) default NULL,
  `dest` varchar(10) default NULL,
  `eistype` varchar(10) default NULL,
  `data` varchar(50) default NULL,
  `sysid` varchar(10) default NULL,
  `pid` varchar(10) NOT NULL,
  `db_time` timestamp NOT NULL default
CURRENT_TIMESTAMP,
PRIMARY KEY (`id`)
) ENGINE=MyISAM
AUTO_INCREMENT=865
DEFAULT CHARSET=latin1;

```

The table can be created using the MySQL Client software or phpMyAdmin. This is the table structure:

id	int(11) NOT NULL auto_increment <i>Primärschlüssel, eindeutige ID des Datensatzes</i>
source_protocol	varchar(20) NOT NULL Quellprotokoll. KNXnet/IP KNXeasy
sernr	varchar(12) NOT NULL Die Seriennummer des KNXeasy
timestamp	varchar(50) NOT NULL Interne KNXeasy Zeit
source	varchar(10) default NULL Physikalische Quelladresse
dest	varchar(10) default NULL Ziel-Gruppenadresse
eistype	varchar(10) default NULL EIS-Typ: EIS_UNDEF EIS_1 EIS_2 ...
data	varchar(50) default NULL Die umgerechneten Klartextdaten
sysid	varchar(10) default NULL



	Verwendete SystemID
pid	varchar(10) NOT NULL Interne ProzessID des KNXeasy für Wartungszwecke
db_time	timestamp NOT NULL default CURRENT_TIMESTAMP Die Zeit des Datenbankrechners

4.3 SYSTEM

On the System tab you can change the internal time of KNXeasy. This time is used to correctly timestamp the internal address table and the telegrams stored in the database.

Figure 6 System

The refresh button loads the current system time from the device. You can manually insert the correct time or use the local time button to insert your client system time. The commit time button saves the time to KNXeasy.

In the System Control section you can restart the internal KNXeasy software or do a complete system reboot. If you use the reboot option, the device will not be available for about a minute.

If there are new firmware revisions you can update your KNXeasy using the Firmware Update section.

5 KNXEASY MONITOR

The KNXeasy monitor can be used to listen to KNXeasy messages on the network. You can also send messages or do status requests.

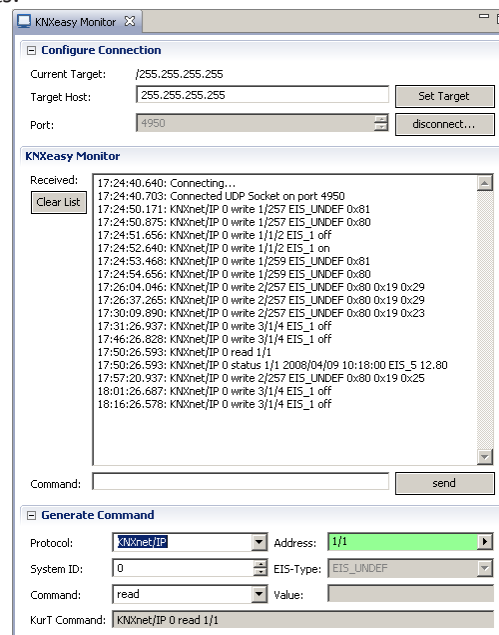

Figure 7 KNXeasy Monitor

To open the KNXeasy monitor click on the window menu and choose Show View > Monitor > KNXeasy Monitor.

To send KNXeasy messages you have to configure a UDP broadcast or unicast address. With the preconfigured address 255.255.255.255 you send KNXeasy messages into every network. If there is a router between your client PC and the KNXeasy, it must be configured to route the UDP packages into the target network.

The default port for KNXeasy is 4950. If you have a firewall, it must not block this port to see the messages. To start recording click on the connect button.

In the main record window you will see all KNXeasy messages. Every message will be labeled with the local PC time. This timestamp does not belong to the KNXeasy protocol. Using the command input you can send KNXeasy messages on your own. These messages can be entered manually or generated using the input mask.



6 KNXEASY FUNCTION

KNXeasY bidirectionally translates KNXnet/IP data into the very simple KNXeasY ASCII protocol.

6.1 KNXNET/IP TO KNXEASY

When KNXeasY receives a telegram from KNXnet/IP it decodes the groupaddress and tries to fetch this to the ESF+ data. If an EIS type has been assigned to that groupaddress, the KNXeasY transforms the data into plain text values.

The generated KNXeasY message will be sent as a write command to the configured UDP broadcast or unicast address. All clients which are listening on the KNXeasY port (default 4950) will receive this message.

The message will also be saved into the internal address state table and to the optional configured MySQL database.

6.2 KNXEASY TO KNXNET/IP

When KNXeasY receives a KNXeasY message, its data will be written to the address state table and the optional MySQL database. The data object will be transformed using the EIS specification in the message. KNXeasY generates a KNXnet/IP package and sends it to the configured Multicast address for the given SystemID.

6.3 KNXEASY STATUS REQUESTS

A KNXeasY status request (read) will be answered with data from the address state table. There is no option to request a status from the KNX installation defined for the KNXnet/IP protocol. When the KNXeasY is installed into an installation, it will take some time until all addresses have been sent at least once and are recorded into the address status table. The answer on the read command (status) will be sent to the client via UDP unicast.

7 CONFIGURATION TOOL FOR THE KNXEASY GATEWAY

Open the bab-tec manager with "manager.exe".



figure 8 b.a.b-technologie Manager

Click on "Configuration" and then on "KNXeas".

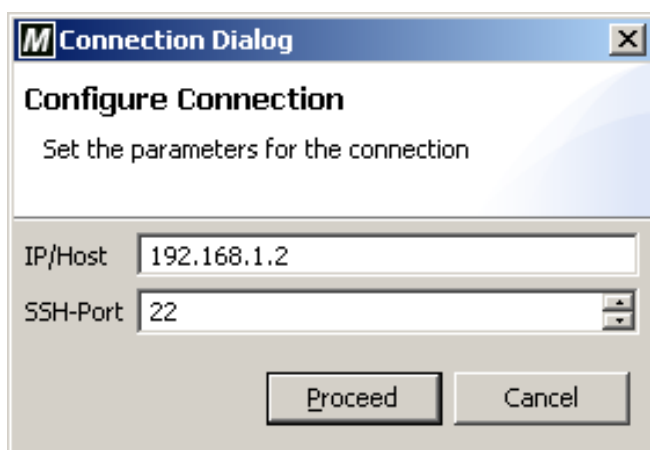

figure 9 Connetion Dialog

Type in the access data for your KNXeas gateway and click "Proceed".

The manager connects to the gateway and the "Network Parameters" page opens.



7.1 CONFIGURATION PAGE NETWORK PARAMETER

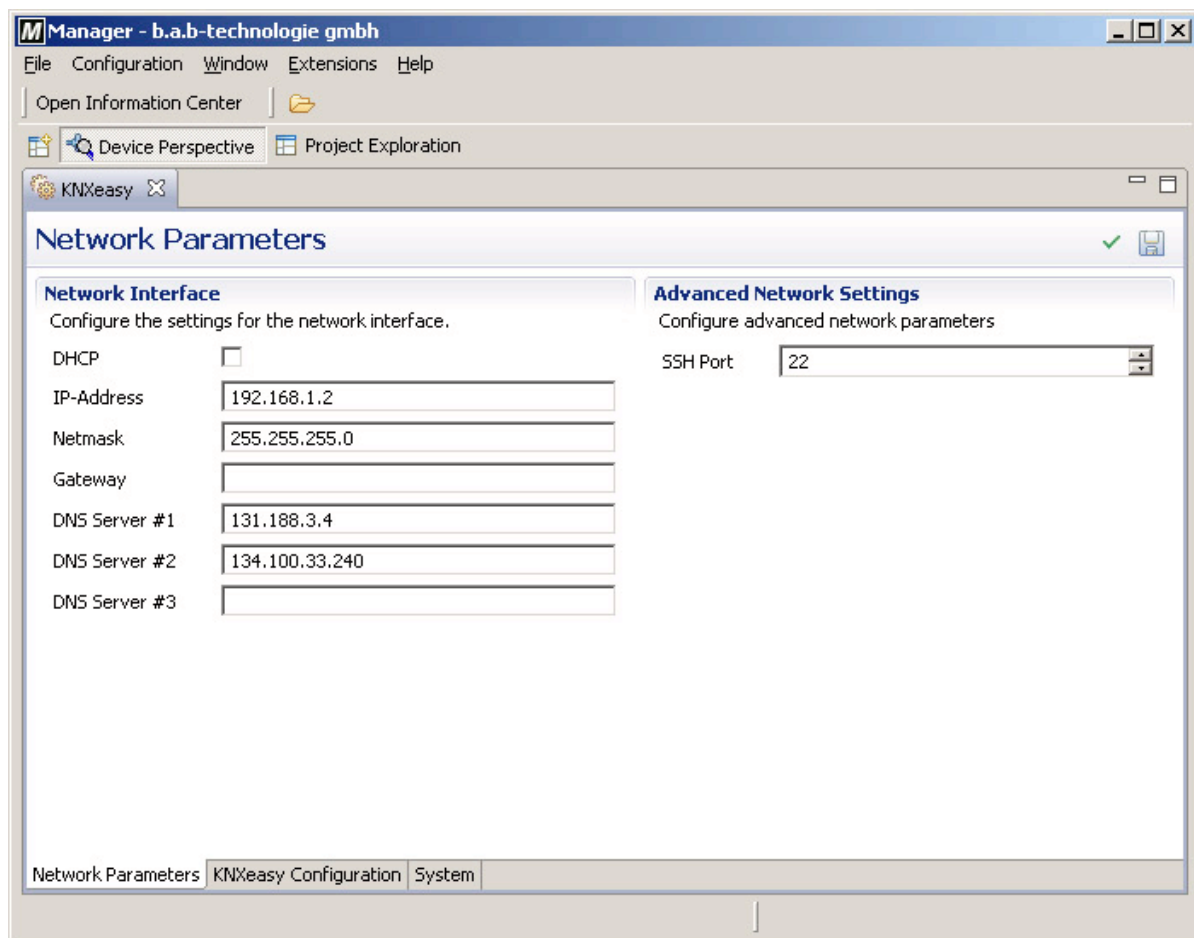

figure 10 Network Parameter

Here you can change the Network configuration of your gateway.

After changing the configuration for your requirements, click on "KNXeasY Configuration" below.

7.2 KNXEASY CONFIGURATION

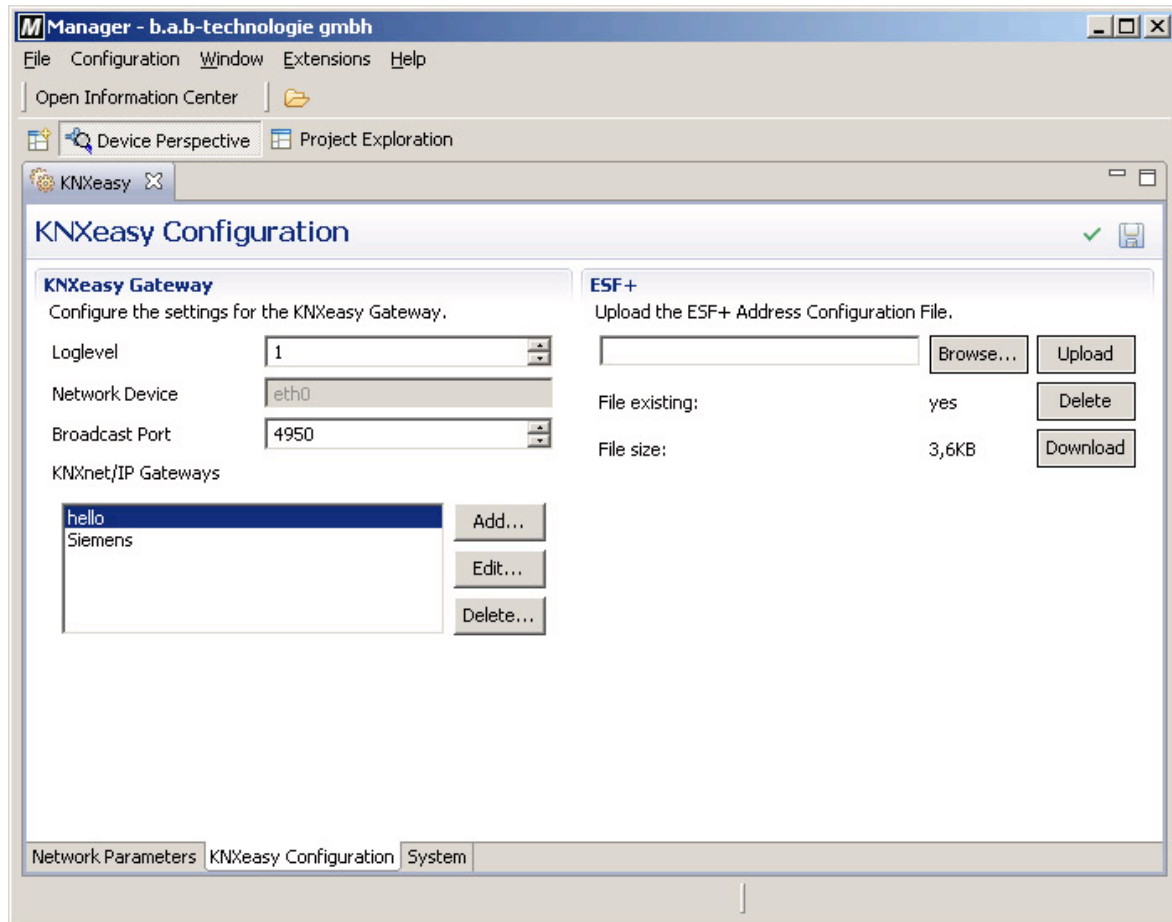

figure 11: KNXeas Configuration

The configuration of the gateway takes place on the left side in the array "KNXeas Gateway".

To add a new gateway, click "Add..."

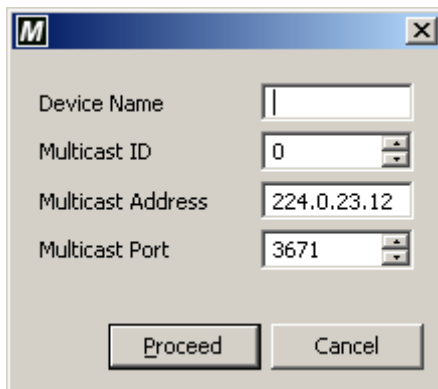

figure 12 Eingabefenster

Enter name, multicast ID, multicast address and multicast port of the new gateway.

Click "Edit..." to change the configuration of existing gateways.



To delete a gateway from the list, click "Delete...".

In the array "ESF+" you can load esfp files into the gateway and download or delete existing files

7.2.1 SYSTEM

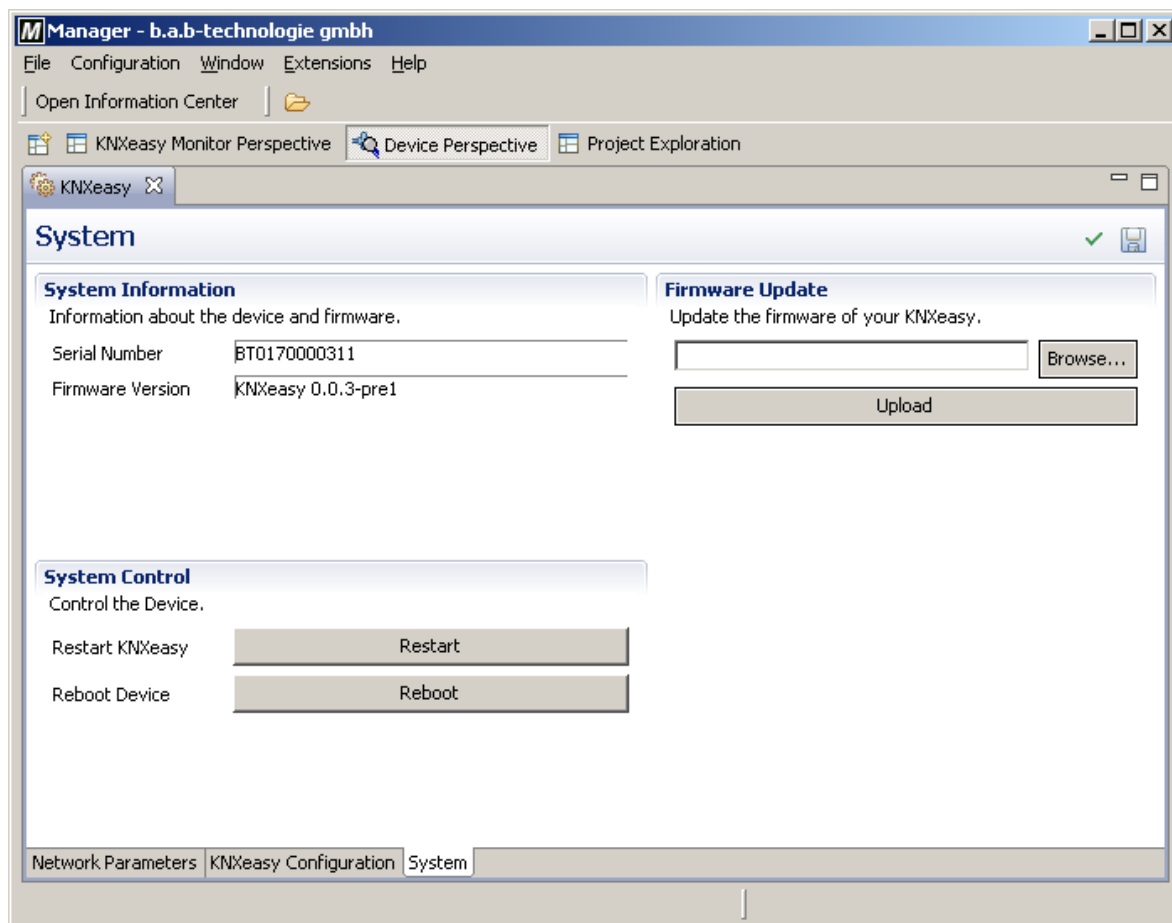

figure 13 System

System information is displayed on this page.

You can restart the KNXeasY software or reboot the gateway (hardware). Furthermore you have the possibility to do a firmware update.

7.3 UPDATEFUNCTION

To install updates or plugins for the manager, click "Extensions" in the menu bar and then on "Install and Update".

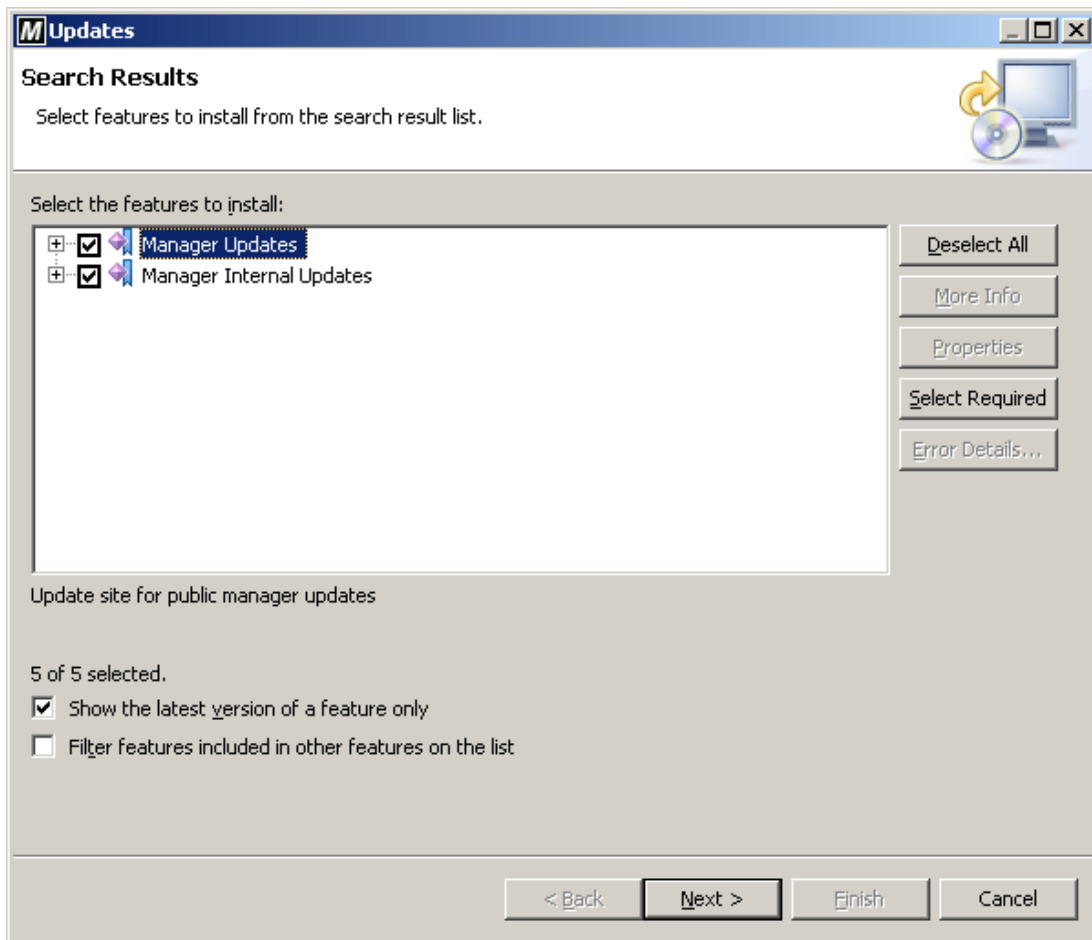

figure 14 Update

Now the manager looks for updates. Choose the updates or plugins you want to install in the following window and proceed with "Next".

Now the chosen updates are shown detailed.

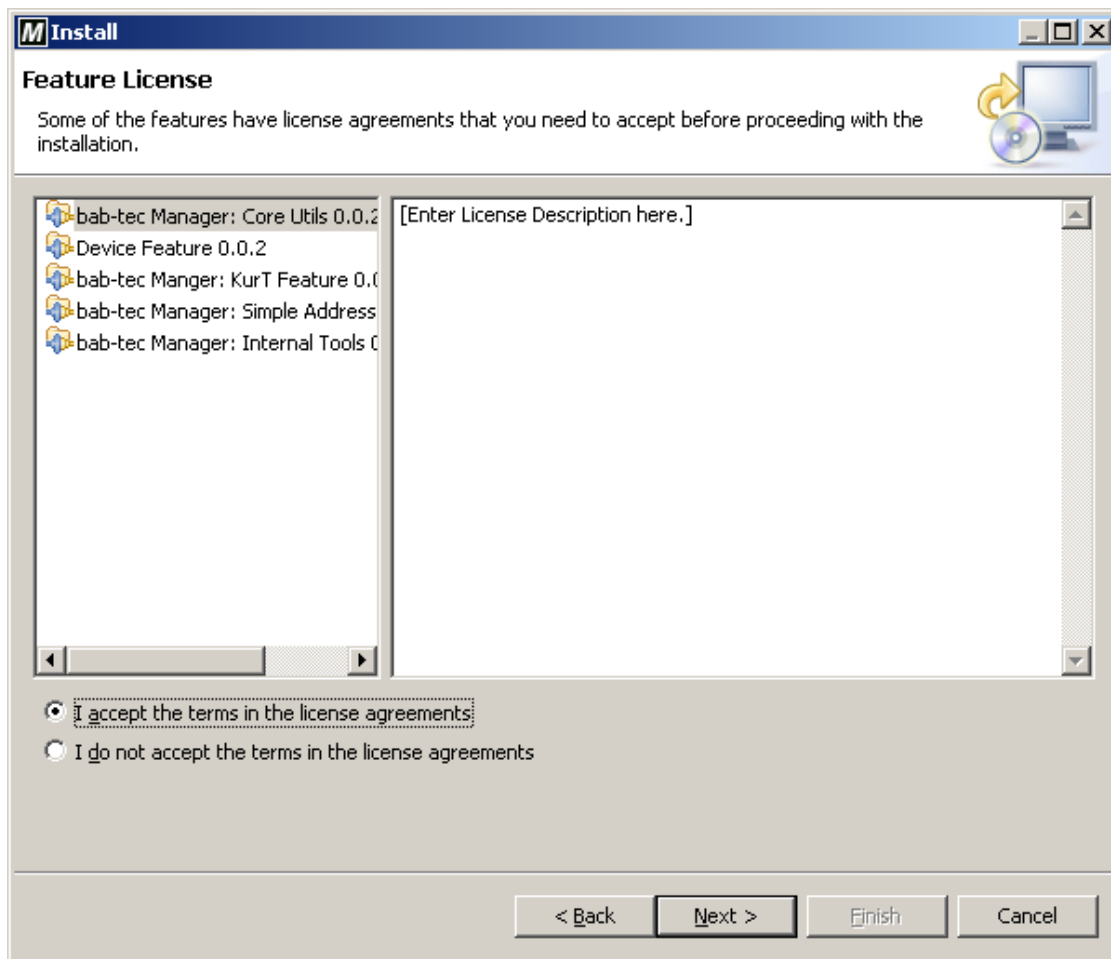

figure 15 Install

Accept the license agreements and click "Next" to download the updates.

Following the download of the updates starts.

After finishing the download, you get asked if you want to install the updates.

Click "Install all".

After the installation of the updates, the manager has to be restarted.

7.4 DATAMANAGEMENT

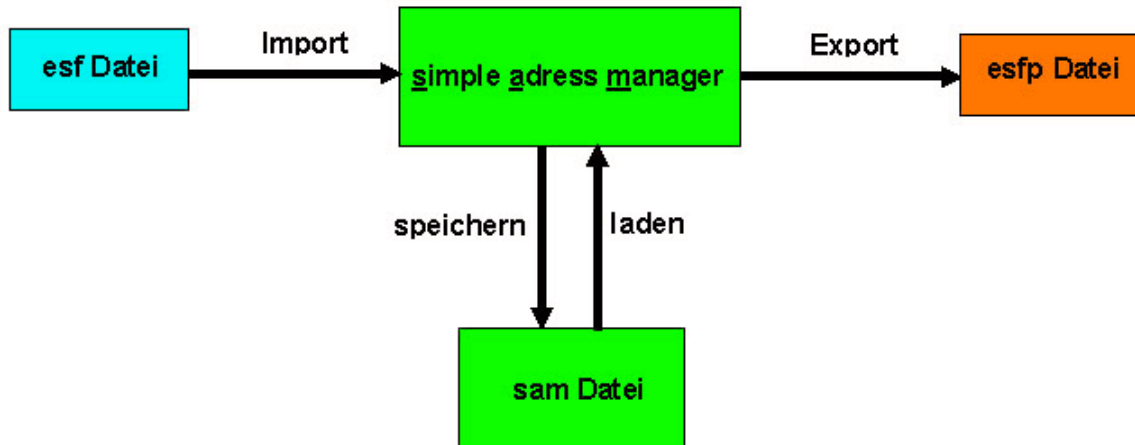

figure 16 datamanagement

The preparation of the EIB data takes place in the "simple adress manager". With that data the KNXeas telegrams are generated.

For this purpose, you first have to create an esf file from the ETS.

(Datei=>Export=>OPC-Export)

This file can be imported with the manager.



7.4.1 IMPORT VON ESF DATEIEN

Click on "File" in the menu bar and then on "Import".



figure 17 Import

Mark "ESF Import" and proceed with "Next".

ESF IMPORT

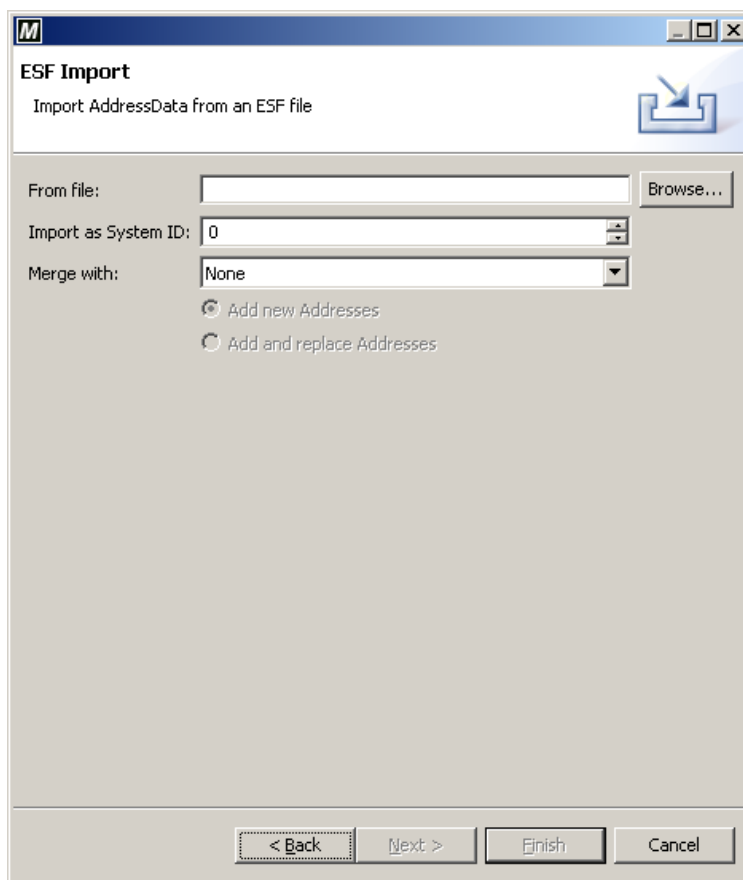

figure 18 ESF Import esf

Choose the esf file, you created with the ETS before and enter the SystemID of the eibPort.

If you have imported an esf file before, you can merge the new with the old esf file. At this, you have the options only to add new group addresses, or to replace existing group addresses.

Click "Finish" to complete this procedure.

7.4.2 EDITING EIB GROUP ADDRESSES

If you have imported an esf file, this file can be viewed and edited with the manager. The editor area opens in every perspective, if an esf file was imported. For proper performance of the gateway, the right EIS types have to be assigned to all group addresses.



Name	Address	Anzahl	EIS
Koffer 1	System ID: 0	22	
Zentral	EIB Maingroup 0	1	
Zentral Aus	0/1		EIS 1 (1 Bit On/Off)
Beleuchtung	EIB Maingroup 1	8	
Lampe 1 schalten	1/0		EIS 1 (1 Bit On/Off)
Lampe 1 dimmen	1/1		EIS 2 (Dimming)
Lampe 2 schalten	1/2		EIS 1 (1 Bit On/Off)
Lampe 2 dimmen	1/3		Undefined
Lampe 3 schalten	1/4		EIS 1 (1 Bit On/Off)
Lampe 4 schalten	1/5		EIS 1 (1 Bit On/Off)
Lampe 1 Wert	1/6		EIS 6 (1 Byte %)
Lampe 2 Wert	1/7		EIS 6 (1 Byte %)
Heizen	EIB Maingroup 2	7	
Heizen	2/0		EIS 1 (1 Bit On/Off)
Sollwert	2/1		EIS 5 (2 Byte FP)
Ist-Wert	2/2		EIS 5 (2 Byte FP)
Komfort-Betrieb	2/3		EIS 1 (1 Bit On/Off)
Nachtbetrieb	2/4		EIS 1 (1 Bit On/Off)
Frostschutz	2/5		EIS 1 (1 Bit On/Off)
aktueller Sollwert	2/6		EIS 5 (2 Byte FP)
Jalousie	EIB Maingroup 3	3	
Kontakte	EIB Maingroup 4	3	

figure 19 ESF

To define EIS types, click on the entry in the column "EIS" and change the value.

7.4.3 EIS TYPEN

EIS 1	On/Off (1 Bit)
EIS 2	Dim (4 Bit)
EIS 3	Time (3 Byte)
EIS 4	Date (3 Byte)
EIS 5	Floating-point (2 Byte)
EIS 6	Per cent value (1 Byte)
EIS 7	Motor (1 Bit)
EIS 8	Priority (2 Bit)
EIS 9	Floating-point (4 Byte)
EIS 10 unsigned	Counter unsigned (2 Byte)
EIS 10 signed	Counter signed (2 Byte)
EIS 11 unsigned	Counter unsigned (4 Byte)
EIS 11 signed	Counter signed (4 Byte)
EIS 12	Access code (4 Byte)
EIS 13	ASCII value (1 Byte)
EIS 14 unsigned	Counter unsigned (1 Byte)
EIS 14 signed	Counter signed (1 Byte)
EIS 15	Character string (14 Byte)

7.4.4 SAVING DATA AS SAM FILE

Imported (and maybe edited) esf files get saved in the bab-tec manager as simple address manager (sam) files.

Click on "File" in the menubar and then on "Save as".

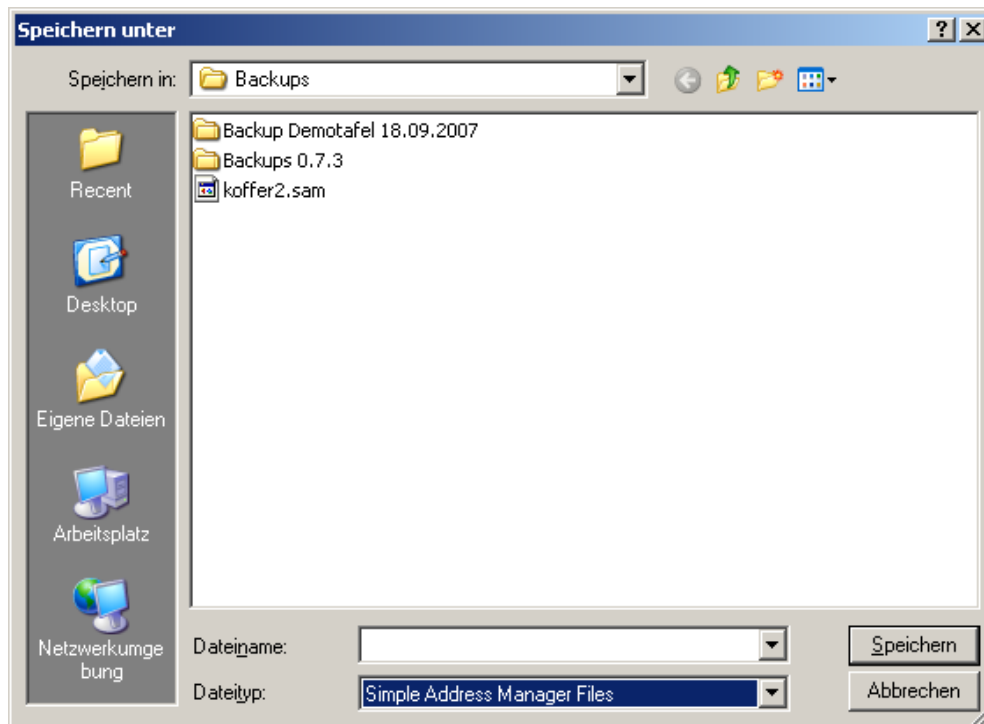

figure 20 Save Data

Choose the path for the file and proceed with "Save".

7.4.5 EXPORT OF ESF+ FILES

To use the sam files in the KNXeas gateway, the files have to be exported to esf+ files.

Click on "File" in the menubar and then on "Export".

Mark "ESF+ Export" and proceed with "Next".



figure 21 ESF Export

Choose the path for the esf+ file and click "Finish" to export the file.

7.4.6 PERSPECTIVES AND VIEWS

The desktop of the bab-tec manager is based on perspectives. They are shown as tabs. Click on "Window" in the menubar and then on "Open Perspective" to open a new perspective.

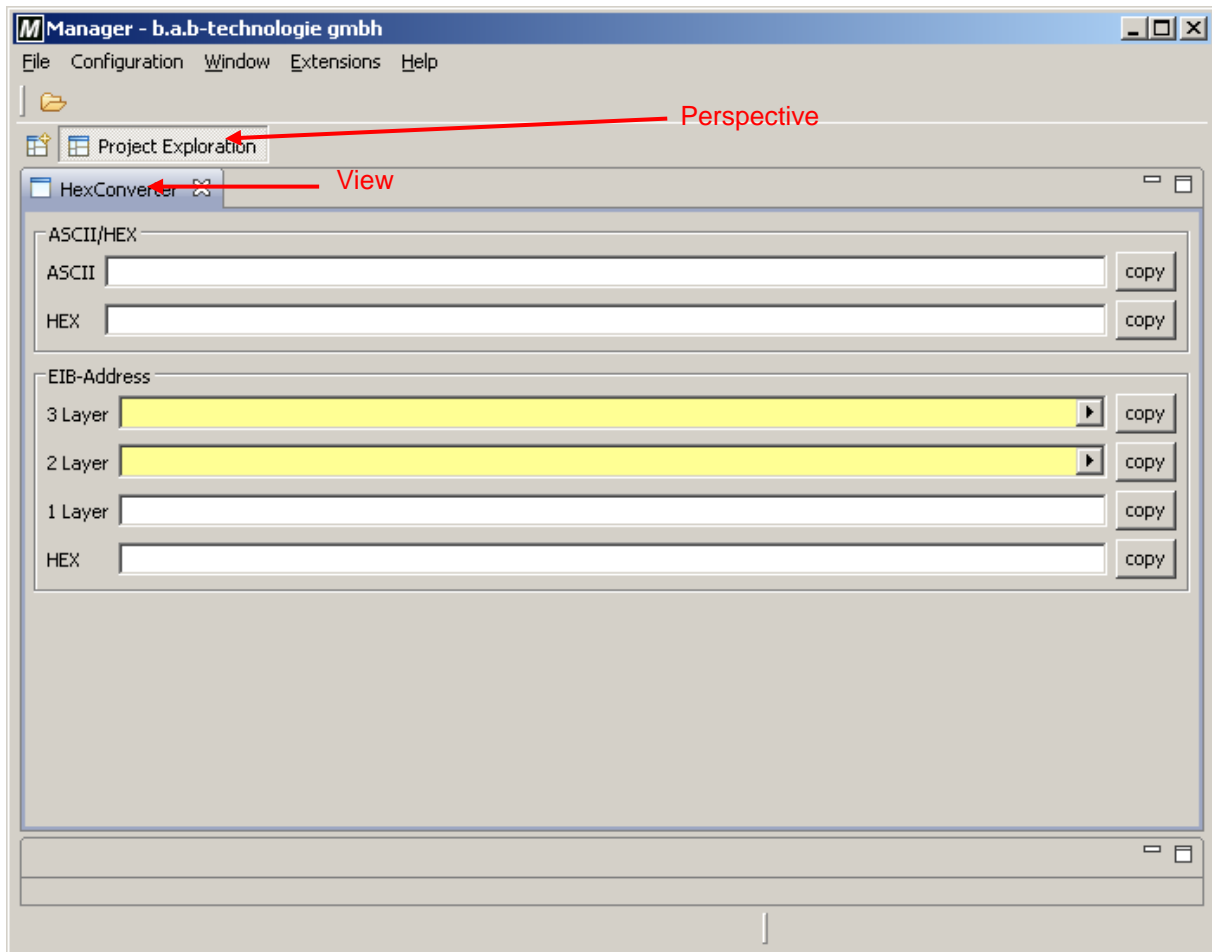

figure 22 ESF Export

You can open different "views" in every perspective. Those are the tools you can work with. To open a new view, click "Views" in the menubar and then on "Show View".

The default views of the perspectives:

KNXeas Monitor Perspective:	KNXeas Monitor
Device Perspective:	Editor area for group addresses Device Overview Device Details
Project Exploration:	Editor area for group addresses Editor area for group addresses

You can open other views in every perspective.

To set the defaults, click the tab of the perspective with the right mouse button and choose "Reset".



7.4.7 VIEWS - HEX CONVERTER

This tool is able to convert ASCII values into hex values and reverse.

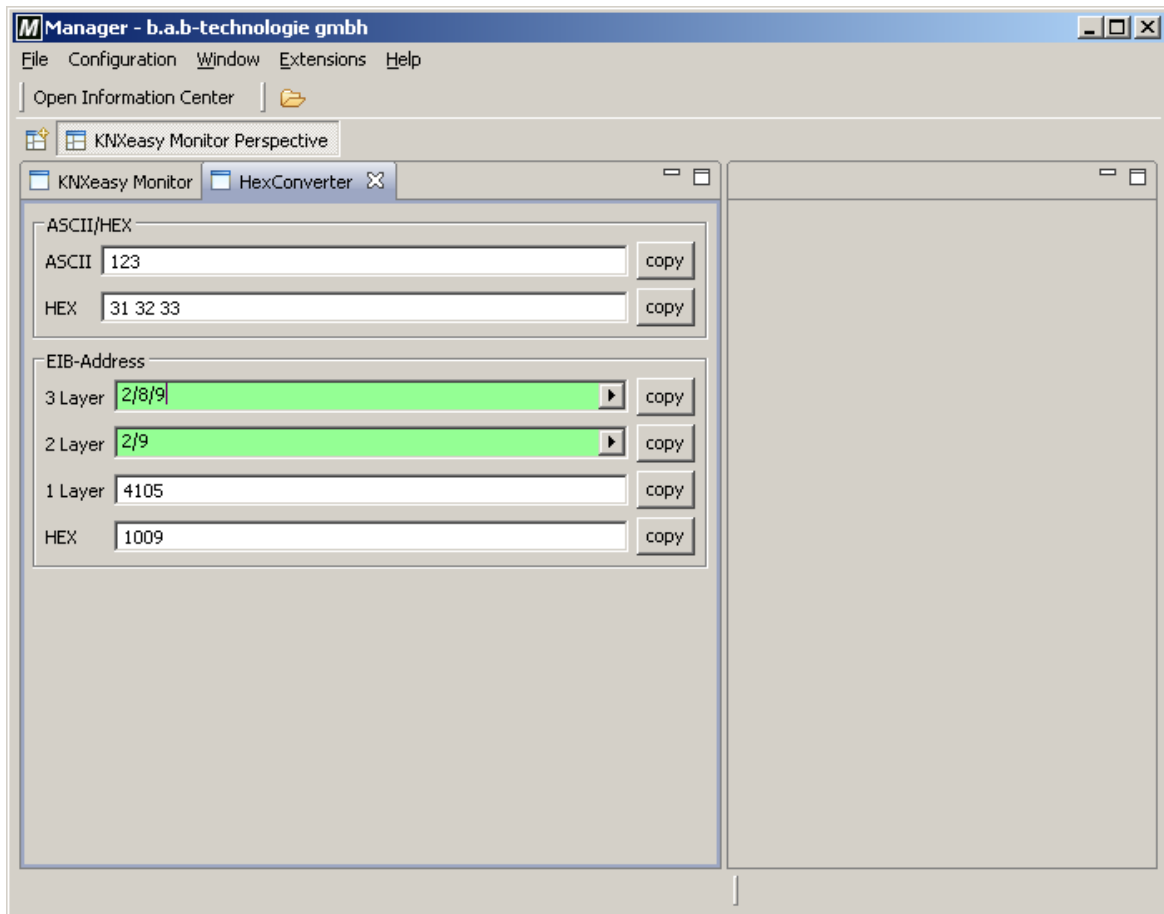

figure 23 Views Hex Converter

Just type in the value, you want to convert into the matching array and the converted values appear in the other arrays.

7.4.8 VIEWS - DEVICE OVERVIEW

In the "Device Overview" all discovered eibPorts get displayed.

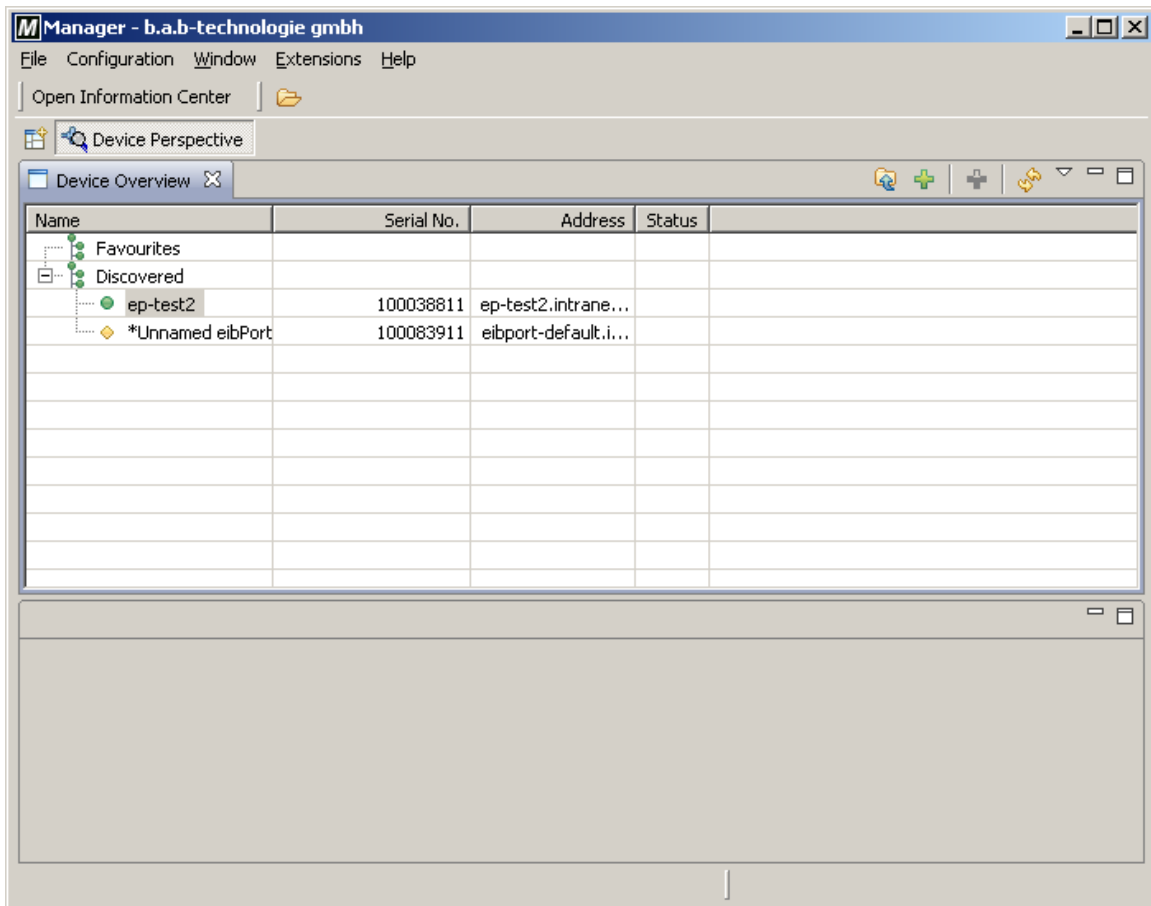

figure 24 Views Device Overview

If you click on an eibPort with the right mouse button, you can add it to, or remove it from the favourites.



7.4.9 VIEWS - DEVICE DETAILS

In the "Device Details" you can watch the configuration of an eibPort. First you have to open the "Device Overview" and mark an eibPort. Then open "Device Details".

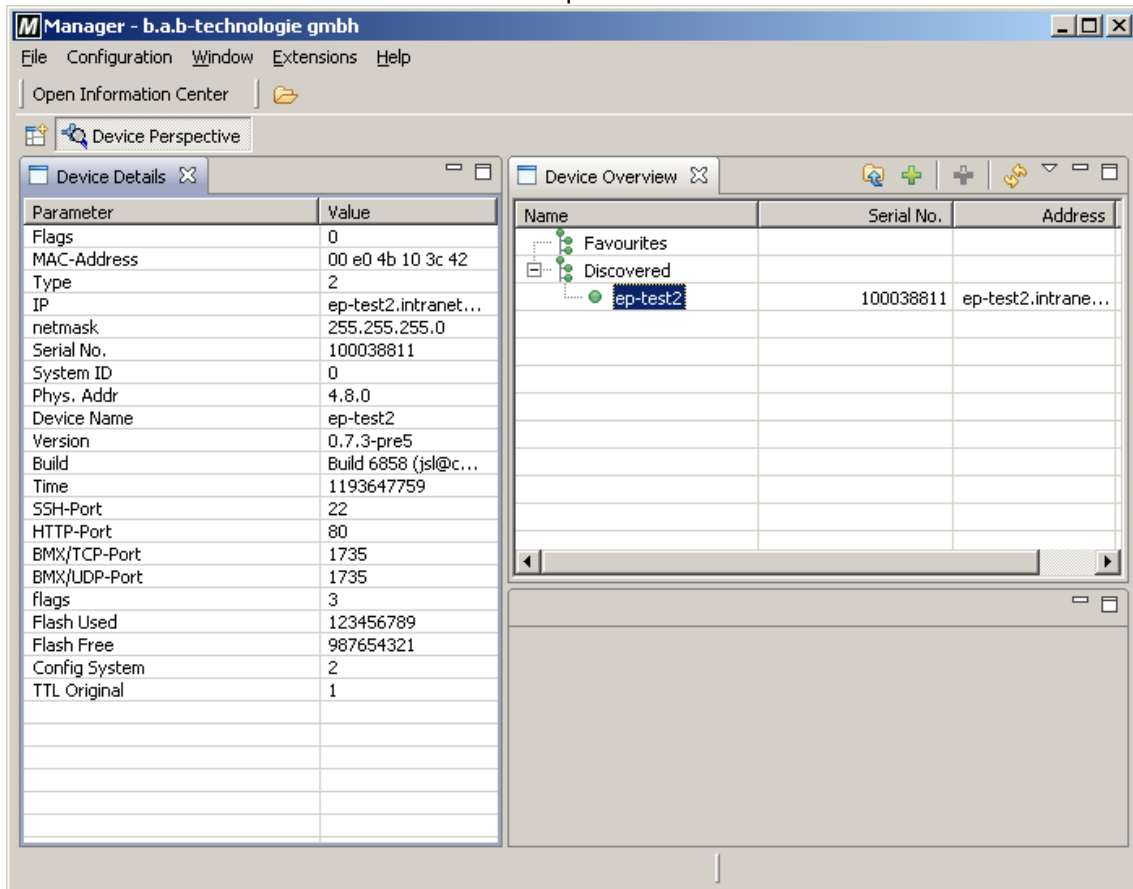

figure 25 Views Device Details

7.4.10 VIEWS - KNXEASY MONITOR

The KNXeasy Monitor is a tool to write values on EIB group addresses or read the current value of an EIB group address. The commands get converted to the KNXeasy protocol and then they get sent to the KNXeasy gateway. The gateway sends the commands to the eibPort.

The KNXeasy Monitor sends the data in the format below:

Protokoll SystemID Command Adress Value

So if you want to send the EIS_1 value "1" on the group address 1/0/1 at the eibPort with SystemID 0, the command reads as follows:

KNXnet/IP 0 write 1/0/1 EIS_1 on

You don't have to write these commands yourself. The manager generates the commands by using the array "Generate Command".

Beispiel: Senden eines Kommandos

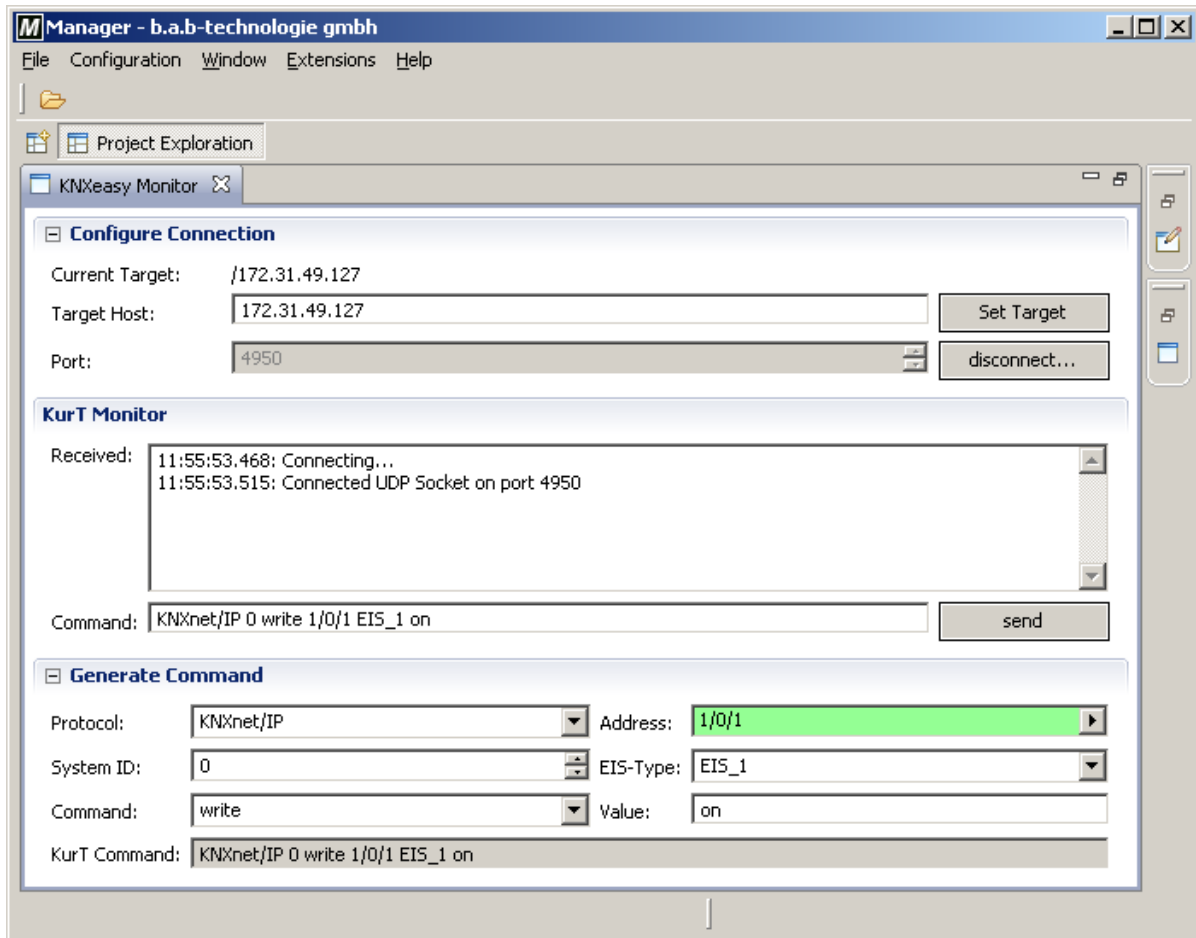

figure 26 Views KNXeas-monitor

First you have to connect to a KNXeas gateway. Enter the IP of the gateway in the array "Target Host" and click "Set Target".

Complete the checkboxes to generate the command. Here we send "1" on the group address 1/0/1 at the eibPort with SystemID "0".

Click "send" after completing the checkboxes. The command gets sent to the gateway and you can see it on the monitor.



8 FAQ

F: How do I discover KNXeasY if I have lost the IP address?

A: Open the discovery window in your manager. Click on the Window menu and choose Show View > Other > Device Overview. You can only discover KNXeasY devices which are in the same network than your client PC or every router between your PC and KNXeasY is configured to forward Multicast messages for the group 239.192.168.27 on port 1735.

F: I don't see any KNXeasY data in the KNXeasY monitor.

A: Verify the KNXeasY configuration for broadcast address and broadcast port. If the broadcast address is not in the configured subnet, you have to enter a valid gateway. The gateway can be KNXeasY itself. if you don't have a network router.

F: Why are KNXeasY messages not translated into KNXnet/IP or not sent on EIB?

A: Verify if your entered broadcast address covers the KNXeasY, too. Check the filter rules in your KNXnet/IP gateways. The group addresses and physical address configured for KNXeasY must not be blocked.