

Introduction



3.5" TFT Display with 256K colors and touchscreen for visualisation and control in KNX systems. The display has a resolution of 320x240 pixels with 256K colors (RGB). We use a 32-bit ARM processor with 200 MHz clock frequency. It is equipped with a Linux operating system and features a mini-USB port and a microSD slot for data storage. The Touch_IT contains a wide range of functions:

Switching and dimming, Display of the switching status, RGB control, On / Off Switching of several devices, Alarm functions, Display and setting of heating control parameters, Multiroom Functions, Astronomic clock timer, Clock timer, Datenlogging, Each page and element can be protected by global or dedicated passwords, Possibility for user defined layouts.

All functions are explained in detail in the following sections.

Guide



1 Product Page / Application Description

The following section describes the installation, the existing connections, the specifications and the commissioning and parameterisation by the ETS.

1.1 Product Page

3,5" Display for visualisation and control in KNX systems.

The **Touch_IT C3-AE-IP65** (on-wall, outdoor / damp room, IP65) is mounted with 2 screws onto the wall.

Installation **Touch_IT C3-xxx** is carried out using a mounting ring. Magnetic elements and the locking screw are used for fixation in a standard 60 mm in-wall socket.

The Touch_IT features an integrated KNX bus coupler and requires additional voltage 9 .. 32VDC / 1,5W.

Different control elements are available for the application software.

The Touch_IT must be projected using the ETS (EIB Tool Software) and the application program. Control elements and page layout can be parametrized using the ETS.

Areas of application

- Switching and dimming of lights
- Adjustment of color and brightness in RGB lights
- Displaying switching states in a building
- Switching various devices on and off
- Operating blinds
- Alarm functions, acoustic and optical
- Alarm display of motion sensors with clear text
- Displaying and setting heating adjustments
- Displaying indoor and outdoor temperature
- Weekly time switch



<p>Display: 3,5" TFT Touchscreen Processor: 200MHz 32-Bit ARM Operating System: Linux</p> <p>Additional Voltage: 9 .. 32VDC / ca. 1,5W</p> <p>Ambient Temperature Operation: -5 .. +55 °C Ambient Temperature Storage: -5 .. +60 °C</p> <p>Optional Temperature-Probe: 1-Wire bus</p> <p>Ambient temperature according to manufacturer's specifications.</p> <p>Protection Touch_IT C3-AE-IP65: IP65 Protection Touch_IT C3-xxx: IP20</p>	<div style="display: flex; justify-content: space-around;"> <div style="text-align: center;"> <p>Rear View -AE -AW -Sx</p> </div> <div style="text-align: center;"> <p>Side Elevation -AE -AW -Sx</p> </div> </div> <div style="display: flex; justify-content: space-around; margin-top: 10px;"> <div style="text-align: center;"> <p>Front View -AE -AW</p> </div> <div style="text-align: center;"> <p>Front View Sx</p> </div> </div> <div style="display: flex; justify-content: space-around; margin-top: 10px;"> <div style="text-align: center;"> <p>Front View AE-IP65</p> </div> <div style="text-align: center;"> <p>Side Elevation AE-IP65</p> </div> </div>
---	--

Commissioning and Connector Description

Commissioning the KNX display is carried out using the ETS (EIB Tool Software) and the corresponding application software. At delivery, the device is unprogrammed. All functions must be parameterized and programmed using the ETS. Please review the documentations belonging to the ETS.

The touch screen is designed for in-wall installation. The degree of protection is IP20. Installation is carried out using the support ring and the magnetic fixing. A locking screw type Torx-6 serves for fixation.

The connections of the Touch_IT C3-AE-IP65 are identical.

Please make sure that electronic parts do not get damaged by tools or cable ends during installation.

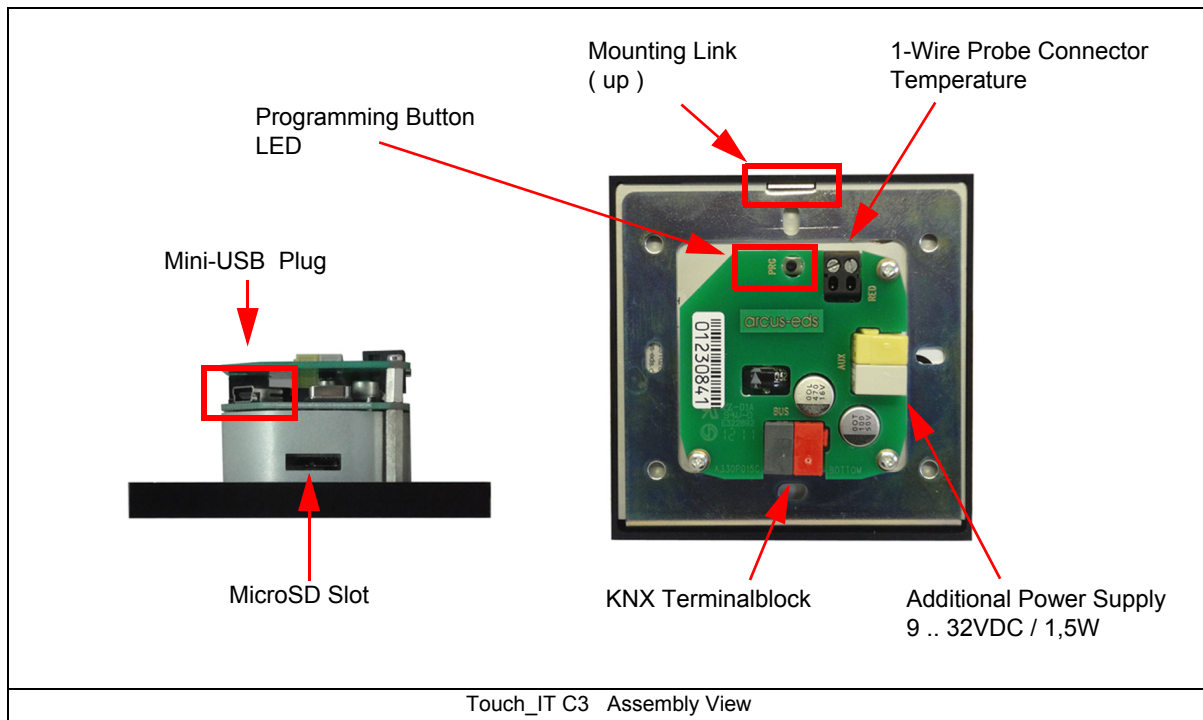

Technical Data

Technical Data - Touch_IT C3

Display	3,5" TFT color display (320x240 RGB) (256k color) touchscreen
Processor	200MHz 32-Bit ARM
Operating system	Linux
Background	Adjustable LED background light
Parameterization	ETS
Max. number of elements / Max. number of pages	8 / (5 control pages + 1 alarm page or 6 control pages)
Ambient temperature, storage	-5 .. +60 °C
Ambient temperature in operation	-5 .. +55 °C
Operational voltage	EIB/KNX bus voltage 21 .. 32VDC
Approx. power consumption	10 mA (at 24V DC)
Additional voltage	9 .. 32VDC / approx. 1.5 W
Bus coupler	Integrated

Technical Data - Touch_IT C3 (continue)

Commissioning via ETS	Touch_IT_xxx.pr5
Connections	EIB-2-polar terminal (red / black) AUX-2-polar terminal (yellow / white)
Optional Temperature Probe (1-Wire)	Yes
On-Wall	
Degree of protection	IP65
Installation type	on wall mounting
Casing	Aluminium anodized
Casing measurements	120 x 80 x 48 mm (W x H x D)
Articlenumber	22310265
In-Wall	
Degree of protection	IP20
Installation type	Installation with a mounting ring
Casing	Various
Casing measurements with bevel	82 x 82 x 8 mm (W x H x D)
Casing measurements square-edged	80,5 x 80,5 x 8 mm (W x H x D)
Articlenumber	22310xxx

Behaviour at Bus Voltage Recovery

All settings carried out using the ETS will be preserved.

Discharging Program and Resetting Device

If the visualization does not react due to a malfunction or incorrect configuration of the programming, the entire project work can be deleted by pressing the programming button. The device will be reset to delivery status. Please hold the programming button while connecting power supply and wait until the application for touch screen calibration appears. Normally, this takes 40-60 seconds. After entering the 5 calibration points, you can transmit your application once again.

1.2 Application Description

The following are the main settings for the Touch_IT in the ETS software are described.
A detailed description follows in Chapter 2, **Description Widgets**.

1.2.1 Main setting in the ETS

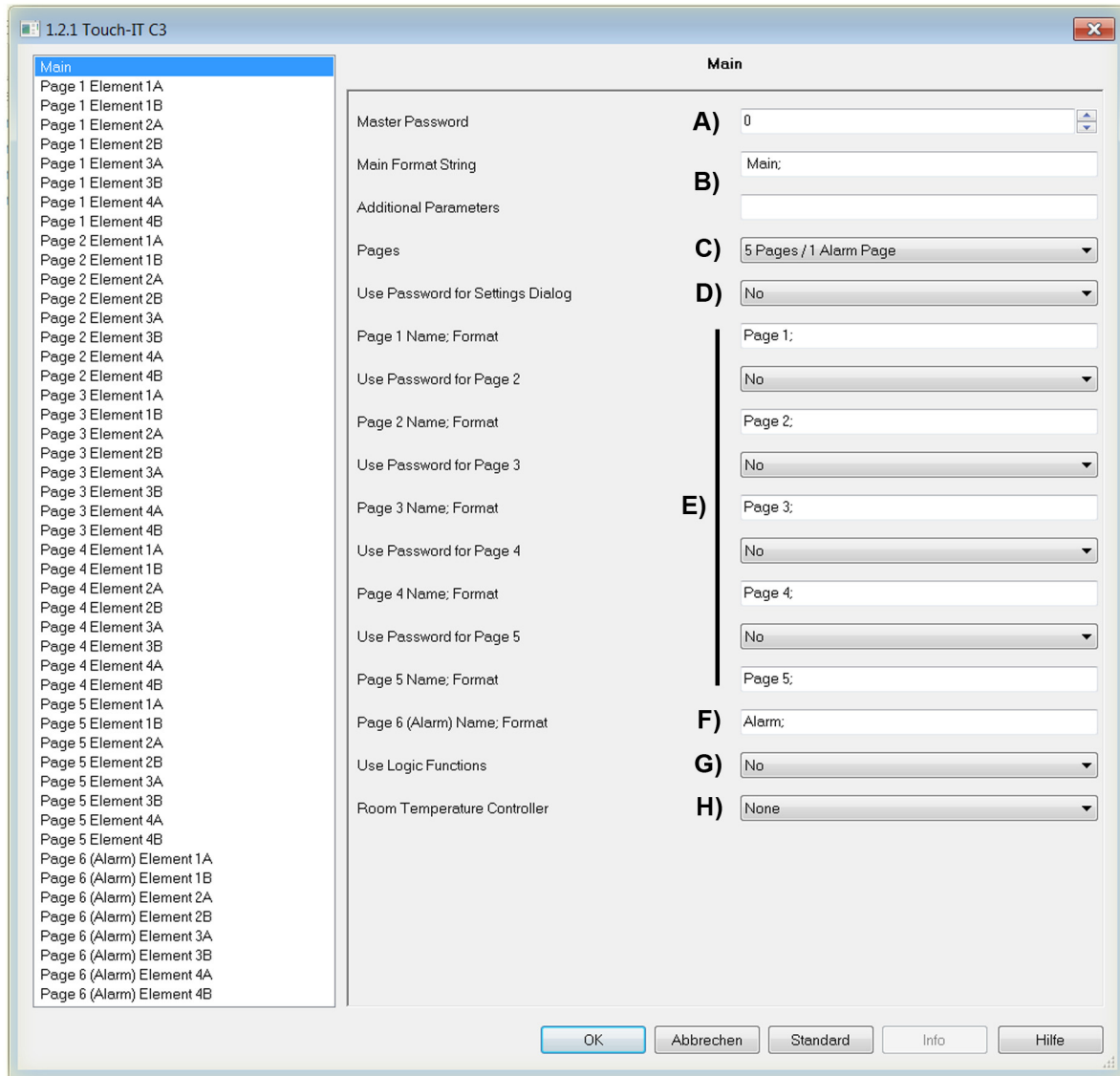

A) Master Password

A 4-digit password can be assigned to protect the different pages or object functions. In case that the value is "0", this function is inactive.

e.g.

In case that the password is "1", "0001" must be entered on the Touch_IT in order to access the protected page or to execute a function of the protected element.

B) Main Format String and Additional Parameters

These fields are used for global parameter setting. The following parameters can be used:

TDSEND	No default value assigned. Date and time will not be sent.
TDSEND=xx	Time allowance for sending time and date. Specified in solid hours. e.g. TDSEND=17 (Time and date will be sent every day at 5 pm)
STDLONG	Interpretation of a manual input as LONG (Default 500ms)
STDLONG=xx	Determines the time (in ms) from which the manual input will be taken as LONG.
STDREP	Default use of the general repetition rate. (Default 300ms)
STDREP=xx	Sets the repetition rate (in ms)
LAYOUT	Disables user's choice. Forces registered layout.
PGH	Defines the maximum display height for the widgets. The menu bar adapts to fill the display.

Two more parameters can be set in order to control standby object 194.

OBJ194OUT

This parameter determines how the output object reacts when the screen saver mode is changed. Values can be sent when activating and leaving the screen saver. The following scheme demonstrates the settings in dependency on the desired actions. Standby mode will be interpreted as an extended screen saver mode.

	Screensaver inactive			
		0	1	x
Screen saver active (or standby)	0	--	SW	Sx
	1	WS	--	xS
	x	Wx	xW	--

Demonstration:
Standby object parameters are to be set as follows: „Send a 1 when activating and a 0 when leaving the screen saver mode“. The outcome of this is:
OBJ194OUT=WS;

OBJ194IN

Incoming telegrams on the system standby object can change the current status of the screen saver. The changes can be defined for the values 0/1, as demonstrated in the following scheme.

	Possible settings				
		xx	Ox	Sx	Wx
Input	0	--	Standby	Screensaver	Wake-Up
	1	--	--	--	--
		xO	OO	SO	WO
	0	--	Standby	Screensaver	Wake-Up
	1	Standby	Standby	Standby	Standby
		xS	OS	SS	WS
	0	--	Standby	Screensaver	Wake-Up
	1	Screensaver	Screensaver	Screensaver	Screensaver
		xW	OW	SW	WW
	0	--	Standby	Screensaver	Wake-Up
	1	Wake-Up	Wake-Up	Wake-Up	Wake-Up

Demonstration:
The interpretation of an incoming telegram is to be carried out as follows:
Change into standby mode at 0, and into wake-up mode at 1
OBJ194IN=OW;

C) Pages

There are two possible options:

- 5 control pages + 1 alarm page
- 6 control pages

D) Use Password for Settings Dialog

Protect system page with a 4-digit password.

E) Page 1-5 Name; Format

The names of the control pages that appear in the layout menu can be assigned here.

The breakdown of widgets per page is homogeneous. By using of the parameter INHOM the page distribution will be set inhomogeneous. The advantages of inhomogeneous distribution is when different sized images are used on the page.

Use Password for Pages 2-5

Except for control page 1, all service pages can be protected/locked with a password.

(Exception: When 6 control pages are defined, page 6 also can be protected with a password.)

F) Page 6 (Alarm) Name; Format

The name of the control or alarm page that appears in the layout menu can be assigned here.

In addition, global alarm settings can be set here.

- RESCAN= Defines the time (in s) when alarm object is rescanned.
- BEEPOFF= Number of acoustic alarm signals
- AUTOHIDE = Leave alarm page if alarm condition is changed or confirmed in a different point.

G) Using Logic Functions

Further information on the logic functions is given in chapter 6, **Logic**.

H) Using Temperature Control

Further information on the regulation of the room temperature is given in chapter 5, **RTR**.



1.2.2 ETS Objects

Up to 196 group addresses can be administered. If no elements are activated yet, only the system objects within topology are displayed.

Nummer	Name	Gruppenadressen	Funktion	Datentyp	Länge	K	L	S	Ü	A	Priorität
192	System Time		Time	Time DPT_TimeOfDay	3 Byte	K	L	-	Ü	-	Niedrig
193	System Date		Date	Date DPT_Date	3 Byte	K	L	-	Ü	-	Niedrig
194	System Standby		Standby	1 bit DPT_Switch	1 bit	K	L	S	-	A	Niedrig
195	System LED1		LED	1 bit DPT_Switch	1 bit	K	L	S	-	A	Niedrig

e.g. Element 1A is active on page 1 and defined as a 1-bit object. Topology will change as follows:

Nummer	Name	Gruppenadressen	Funktion	Datentyp	Länge	K	L	S	Ü	A	Priorität
10	1.1-A Output, Switching		Switch	1 bit DPT_Switch	1 bit	K	L	S	Ü	A	Niedrig
11	1.1-A Input, Feedback		Switch	1 bit DPT_Switch	1 bit	K	L	S	Ü	A	Niedrig
192	System Time		Time	Time DPT_TimeOfDay	3 Byte	K	L	-	Ü	-	Niedrig
193	System Date		Date	Date DPT_Date	3 Byte	K	L	-	Ü	-	Niedrig
194	System Standby		Standby	1 bit DPT_Switch	1 bit	K	L	S	-	A	Niedrig
195	System LED1		LED	1 bit DPT_Switch	1 bit	K	L	S	-	A	Niedrig

Every element includes function-specific objects that can be linked (Cf. chapter 2, **Elements**). The exact analogy between parameter view and object view within topology will be displayed as follows:

e.g. Page 3, element 2B equals 3.2-B within topology.

2 Description Widgets

The following section describes the usable widgets and their special parameterizing and displaying. The breakdown of controls per page is homogeneous. You can set the parameters of the distribution to inhomogeneous. (See Page 6 E) Page 1-5 Name; Format)

2.1 Arrangement of the Control Elements

A maximum of 8 elements can be placed on a Touch_IT page.

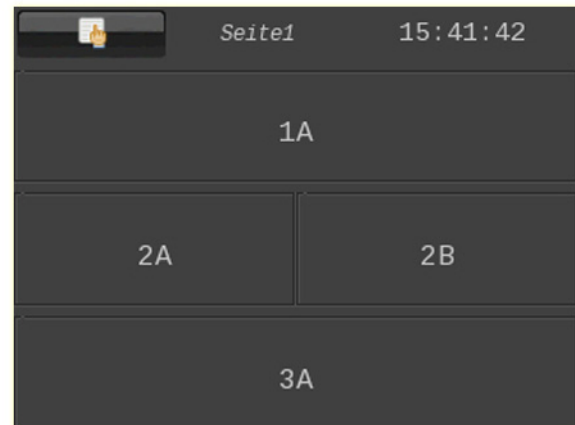
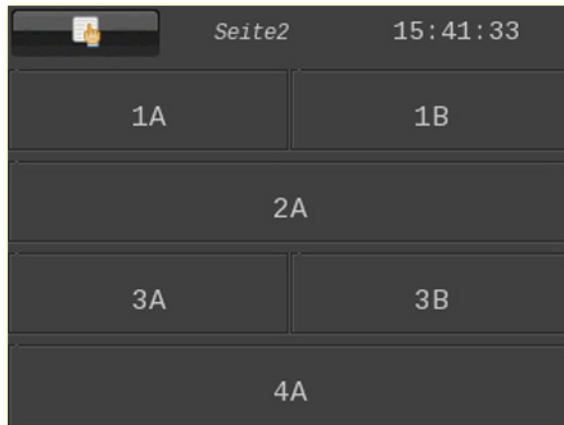
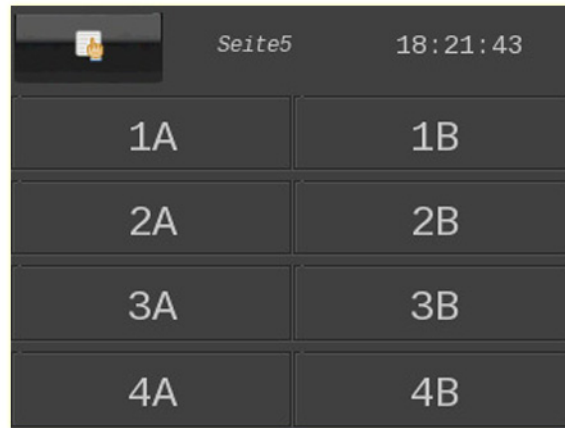

After uploading the parameters, the pages will be formatted automatically. If there is a smaller number of elements on a page, they will be maximized to the available surface (in case that the expand-settings (vertically and horizontally) are enabled).

2.2 Description of the Control Elements

2.2.1 Selecting and Presetting Control Elements

The selection of control elements is carried out through a parameterization within the ETS.

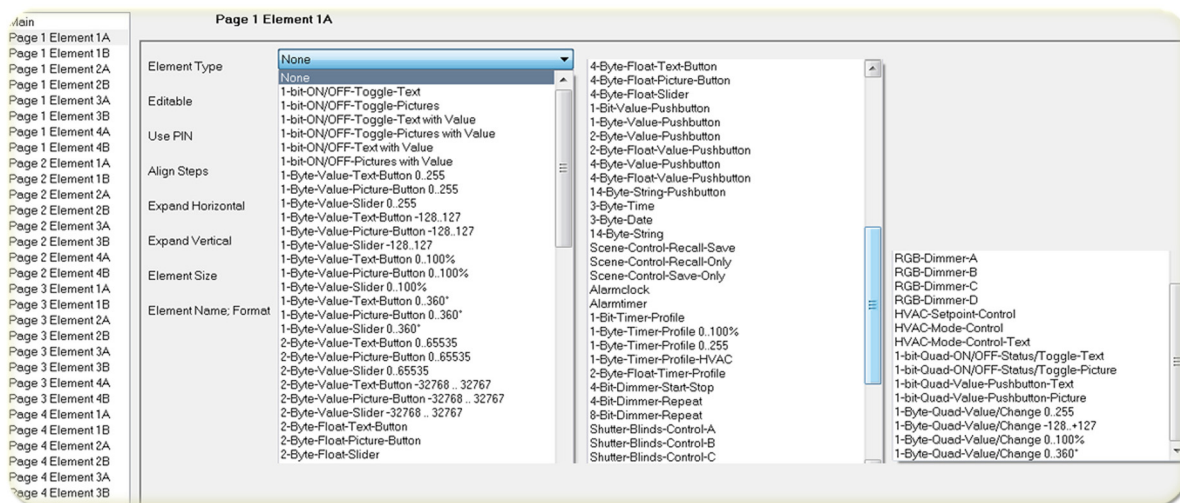
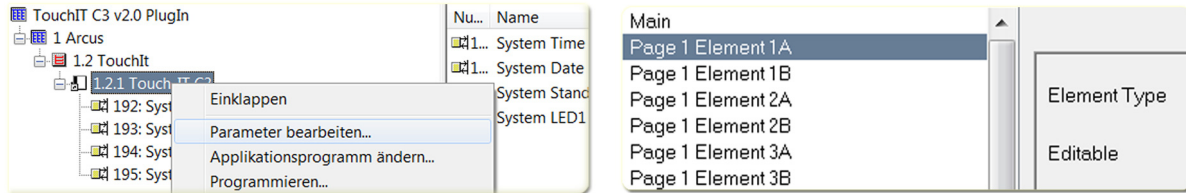

Subsequently, various presets can be adjusted.

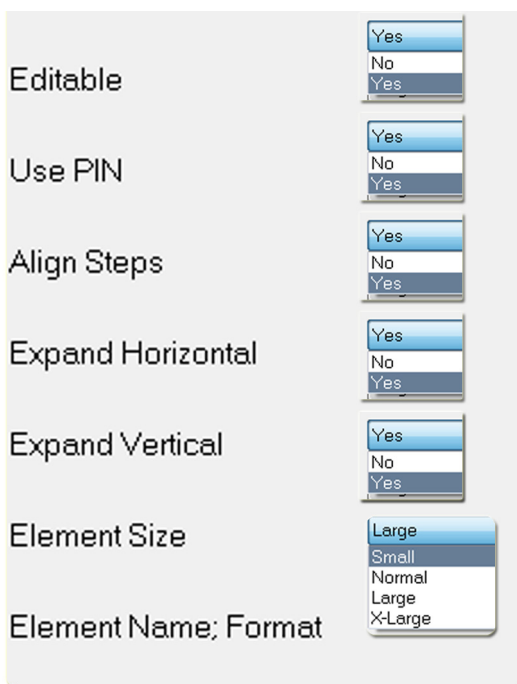

Editable

YES: Element is used as a display with a control element.
NO: Control element is solely used as a display.

Use Pin

Protect control element with a password.

Align Steps

Round value up or down to a multiple of the stepwidth.

Expand Horizontal

Maximize control element horizontally.

Expand Vertical

Maximize control element vertically.

Element Size

Determines, which element size is used.
There are 4 sizes available (Small, Normal, Large, X-Large).
The fine adjustment of the fonts can be carried out directly via the Touch_IT.

Element name, format

This parameter is explained more in detail for every control element in another document.

Examples	Element Name; Format
	<p>1Bit-Toggle-T; B0=OFF; B1=ON;</p>

2.3 Guide to the Detailed Descriptions of the Available Control Elements

 <div data-bbox="308 1010 483 1099">1 Bit</div>	 <div data-bbox="576 1010 751 1099">1 Byte</div>	 <div data-bbox="844 1010 1019 1099">2 Byte</div>	 <div data-bbox="1112 1010 1287 1099">3 Byte</div>
 <div data-bbox="308 1274 483 1364">4 Byte</div>	 <div data-bbox="576 1274 751 1364">14 Byte</div>	 <div data-bbox="844 1274 1019 1364">Szenen</div>	 <div data-bbox="1112 1274 1287 1364">Licht/RGB</div>
 <div data-bbox="308 1538 483 1628">Dimmer</div>	 <div data-bbox="576 1538 751 1628">Jalousien</div>	 <div data-bbox="844 1538 1019 1628">RTR</div>	 <div data-bbox="1112 1538 1287 1628">Timer</div>
 <div data-bbox="308 1803 483 1892">Datalogging</div>	<div data-bbox="576 1803 751 1892"></div>	<div data-bbox="844 1803 1019 1892"></div>	<div data-bbox="1112 1803 1287 1892"></div>

2.4 Overview 1-Bit Elements

Image	Element Number	Element Type	Details Page
	Range of Values	Format	
	1	1-bit-ON/OFF-Toggle-Text	 12
	0/1	B0,B1,AL,AH,NOBG,LOGIC,BSWAP,RDRQ,PIN	
	2	1-bit-ON/OFF-Toggle-Picture	 13
	0/1	IMGSET,AL,AH,NOBG,LOGIC,BSWAP,RDRQ,PIN	
	3	1-bit-ON/OFF-Toggle-Text with Value	 14
	0/1	W,L0,L1,B0,B1,AL,AH,NOBG,LOGIC,BSWAP,LSWAP,RDRQ,PIN	
	4	1-bit-ON/OFF-Toggle-Picture with Value	 15
	0/1	W,IMGSET,L0,L1,B0,B1,AL,AH,NOBG,LOGIC,BSWAP,LSWAP,RDRQ,PIN	
	5	1-bit-ON/OFF-Text with Value	 16
	0/1	W,L0,L1,B0,B1,AL,AH,NOBG,LOGIC,BSWAP,LSWAP,RDRQ,PIN	
	6	1-bit-ON/OFF-Picture with Value	 17
	0/1	W,L0,L1,B0,B1,IMGSET,AL,AH,NOBG,LOGIC,BSWAP,LSWAP,RDRQ,PIN	
	40	1-bit-Value-Pushbutton	 18
	0/1	IMG,PRESS,RELEASE,LABEL,NOBG,JUMP,LOGIC,LOGICR,PIN	
	62	1-bit-Timer-Profile	 19
	0/1	W,L0,L1,OVRTO,NOBG,IMG,RDRQ,PIN,PPIN	
	85	1-bit-Quad-ON/OFF-Status/Toggle-Text	 20
	4x 0/1	LABELS,N,W,NOBG,ALARM,RDRQ,PIN	
	86	1-bit-Quad-ON/OFF-Status/Toggle-Picture	 21
	4x 0/1	IMGSETS,N,W,NOBG,ALARM,RDRQ,PIN	
	87	1-bit-Quad-Value-Pushbutton-Text	 22
	4x 1	LABELS,N,W,NOBG,PRESS,PIN	
	88	1-bit-Quad-Value-Pushbutton-Picture	 23
	4x 1	IMGSETS,N,W,NOBG,PRESS,PIN	

2.4.1 1-bit-ON/OFF-Toggle-Text

ETS Objects		
Range of values	0/1	
Input	Feedback	1 Bit
Output	Switching	1 Bit

Format	
B0	Text default for button on "0"
B1	Text default for button on "1"
NOBG	No button background
BSWAP	Switch between display of the current state and the subsequent state (button)
LOGIC	Function call or direct incorporation of a logical function
RDRQ	Read Request
PIN	In case "Use PIN" is selected, an individual password can be assigned using PIN
AL	Alarm lower limit ONLY ON ALARM PAGE
AH	Alarm upper limit ONLY ON ALARM PAGE

Simple circuit element to send/receive a 1-bit value 0/1.

Set the displayed texts on the buttons using **B0** and **B1**.

NOBG eliminates the button's surface and the display is visualized directly on the background.

BSWAP is used to switch between the states of the buttons: display of subsequent state (standard display) or display of the current state.

Using **LOGIC**, LUA functions can be activated or manually incorporated in a LUA syntax-based logical function.

RDRQ sent a read request at start-up for the used widgets. This parameter only works when Communication Address and Receive Flag are set.

If "Use PIN" is selected, the default master password will be used in case **PIN** is not set. Using **PIN**, an individual password can be assigned.

AL/AH can only be used on alarm page. They serve as a limit setting the temporal point from which an alarm is detected. **AL/AH** can only be used on alarm page. They serve as a limit setting the temporal point from which an alarm is detected.

Examples	Element Name; Format
	1Bit-Toggle-T; B0=OFF; B1=ON;
	1Bit-Toggle-T; B0=OFF; B1=ON;

2.4.2 1-bit-ON/OFF-Toggle-Picture

ETS Objects		
Range of values	0/1	
Input	Feedback	1 Bit
Output	Switching	1 Bit

Format	
IMGSET	Choosing set of images
NOBG	No button background
BSWAP	Switch between display of the current state and the subsequent state (button)
LOGIC	Function call or direct incorporation of a logical function
RDRQ	Read Request
PIN	In case "Use PIN" is selected, an individual password can be assigned using PIN
AL	Alarm lower limit ONLY ON ALARM PAGE
AH	Alarm upper limit ONLY ON ALARM PAGE

Simple circuit element to send/receive a 1-bit value 0/1.
 Use **IMGSET** to chose the set of images you want to use.
NOBG eliminates the button's surface and the display is visualized directly on the background.
BSWAP is used to switch between the states of the buttons: display of subsequent state (standard display) or display of the current state.
 Using **LOGIC**, LUA functions can be activated or manually incorporated in a LUA syntax-based logical function.
RDRQ sent a read request at start-up for the used widgets. This parameter only works when Communication Address and Receive Flag are set.
 If "Use PIN" is selected, the default master password will be used in case **PIN** is not set. Using **PIN**, an individual password can be assigned.
AL/AH can only be used on alarm page. They serve as a limit setting the temporal point from which an alarm is detected.

Examples	Element Name; Format
	1Bit-Toggle-P; IMGSET=light;
	1Bit-Toggle-P; IMGSET=dnd;



2.4.3 1-bit-ON/OFF-Toggle-Text with Value

ETS Objects		
Range of values	0/1	
Input	Feedback	1 Bit
Output	Switching	1 Bit

Format	
W	Determines width of button's surface
B0	Text default for button on "0"
B1	Text default for button on "1"
L0	Text default for display on "0"
L1	Text default for display on "1"
NOBG	No button background
BSWAP	Switch between display of the current state and the subsequent state (button)
LSWAP	Switch between display of the current state and the subsequent state (display)
LOGIC	Function call or direct incorporation of a logical function
RDRQ	Read Request
PIN	In case "Use PIN" is selected, an individual password can be assigned using PIN
AL	Alarm lower limit ONLY ON ALARM PAGE
AH	Alarm upper limit ONLY ON ALARM PAGE

Simple circuit element to send/receive a 1-bit value 0/1.

W (in Pixel) determines the width of the button's surface.

Use **B0** and **B1** to determine the button's texts.

Use **L0** and **L1** to determine the texts to be displayed.

NOBG eliminates the button's surface and the display is visualized directly on the background.

BSWAP is used to switch between the states of the buttons: display of subsequent state (standard display) or display of the current state.





LSWAP is used to switch between the states of the display: display of subsequent state (standard display) or display of the current state.

Using **LOGIC**, LUA functions can be activated or manually incorporated in a LUA syntax-based logical function.

RDRQ sent a read request at start-up for the used widgets. This parameter only works when Communication Address and Receive Flag are set.

If "Use PIN" is selected, the default master password will be used in case **PIN** is not set. Using **PIN**, an individual password can be assigned.

AL/AH can only be used on alarm page. They serve as a limit setting the temporal point from which an alarm is detected.

Examples	Element Name; Format
	1Bit-Toggle-T; B0=AUS; B1=AN; L0=AUS; L1=EIN; BSWAP;
	1Bit-Toggle-T; B0=AUS; B1=AN; L0=AUS; L1=EIN;
	1Bit-Toggle-T; B0=OFF; B1=ON; L0=OFF; L1=ON; LSWAP;
	1Bit-Toggle-T; B0=OFF; B1=ON; L0=OFF; L1=ON; W=80;

2.4.4 1-bit-ON/OFF-Toggle-Picture with Value

ETS Objects		
Range of values	0/1	
Input	Feedback	1 Bit
Output	Switching	1 Bit

Format	
W	Determines width of button's surface
IMGSET	Choosing set of images
B0	Text default for button on "0"
B1	Text default for button on "1"
L0	Text default for display on "0"
L1	Text default for display on "1"
NOBG	No button background
BSWAP	Switch between display of the current state and the subsequent state (button)
LSWAP	Switch between display of the current state and the subsequent state (display)
LOGIC	Function call or direct incorporation of a logical function
RDRQ	Read Request
PIN	In case "Use PIN" is selected, an individual password can be assigned using PIN
AL	Alarm lower limit ONLY ON ALARM PAGE
AH	Alarm upper limit ONLY ON ALARM PAGE

Simple circuit element to send/receive a 1-bit value 0/1.

W (in Pixel) determines the width of the button's surface.

Use **IMGSET** to chose the set of images you want to use.

Use **B0** and **B1** to determine the button's texts.

Use **L0** and **L1** to determine the texts to be displayed.

NOBG eliminates the button's surface and the display is visualized directly on the background.

BSWAP is used to switch between the states of the buttons: display of subsequent state (standard display) or display of the current state.



LSWAP is used to switch between the states of the display: display of subsequent state (standard display) or display of the current state.

Using **LOGIC**, LUA functions can be activated or manually incorporated in a LUA syntax-based logical function.

RDRQ sent a read request at start-up for the used widgets. This parameter only works when Communication Address and Receive Flag are set.

If "Use PIN" is selected, the default master password will be used in case **PIN** is not set. Using **PIN**, an individual password can be assigned.

AL/AH can only be used on alarm page. They serve as a limit setting the temporal point from which an alarm is detected.

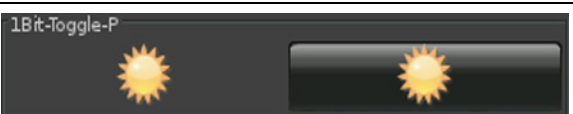
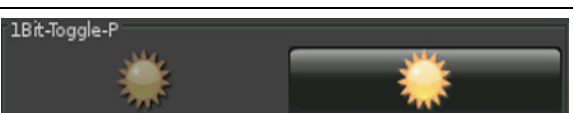
Examples	Element Name; Format
	1Bit-Toggle-P; B0=AUS; B1=AN; IMGSET=light;
	1Bit-Toggle-P; L0=AUS; L1=AN; IMGSET=light;
	1Bit-Toggle-P; IMGSET=light; BSWAP;
	1Bit-Toggle-P; IMGSET=light;

2.4.5 1-bit-ON/OFF-Text with Value

ETS Objects		
Range of values	0/1	
Input	Feedback	1 Bit
Output	Switching	1 Bit

Format	
W	Determines width of display's surface
B0	Text default for button on "0"
B1	Text default for button on "1"
L0	Text default for display on "0"
L1	Text default for display on "1"
NOBG	No button background
BSWAP	Switch between display of the current state and the subsequent state (button)
LSWAP	Switch between display of the current state and the subsequent state (display)
LOGIC	Function call or direct incorporation of a logical function
RDRQ	Read Request
PIN	In case "Use PIN" is selected, an individual password can be assigned using PIN
AL	Alarm lower limit ONLY ON ALARM PAGE
AH	Alarm upper limit ONLY ON ALARM PAGE

Simple circuit element to send/receive a 1-bit value 0/1.

W (in Pixel) determines the width of the display's surface.

Use **B0** and **B1** to determine the button's texts.

Use **L0** and **L1** to determine the texts to be displayed.

NOBG eliminates the button's surface and the display is visualized directly on the background.

BSWAP is used to switch between the states of the buttons: display of subsequent state (standard display) or display of the current state.

LSWAP is used to switch between the states of the display: display of subsequent state (standard display) or display of the current state.

Using **LOGIC**, LUA functions can be activated or manually incorporated in a LUA syntax-based logical function.

RDRQ sent a read request at start-up for the used widgets. This parameter only works when Communication Address and Receive Flag are set.

If "Use PIN" is selected, the default master password will be used in case **PIN** is not set. Using **PIN**, an individual password can be assigned.

AL/AH can only be used on alarm page. They serve as a limit setting the temporal point from which an alarm is detected.

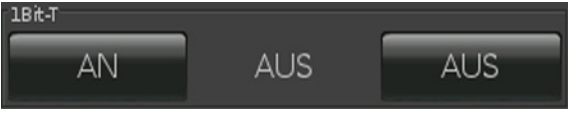
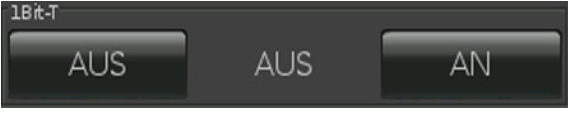
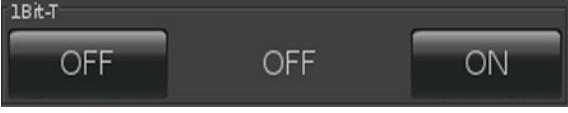
Examples	Element Name; Format
	1Bit-T; B0=AUS; B1=AN; L0=AUS; L1=EIN; BSWAP;
	1Bit-T; B0=AUS; B1=AN; L0=AUS; L1=EIN;
	1Bit-T B0=OFF; B1=ON; L0=OFF; L1=ON; W=80;

2.4.6 1-bit-ON/OFF-Picture with Value

ETS Objects		
Range of values	0/1	
Input	Feedback	1 Bit
Output	Switching	1 Bit

Format	
W	Determines width of display's surface
IMGSET	Choosing set of images
B0	Text default for button on "0"
B1	Text default for button on "1"
L0	Text default for display on "0"
L1	Text default for display on "1"
NOBG	No button background
BSWAP	Switch between display of the current state and the subsequent state (button)
LSWAP	Switch between display of the current state and the subsequent state (display)
LOGIC	Function call or direct incorporation of a logical function
RDRQ	Read Request
PIN	In case "Use PIN" is selected, an individual password can be assigned using PIN
AL	Alarm lower limit ONLY ON ALARM PAGE
AH	Alarm upper limit ONLY ON ALARM PAGE

Simple circuit element to send/receive a 1-bit value 0/1.

W (in Pixel) determines the width of the display surface.

Use **IMGSET** to chose the set of images you want to use.

Use **B0** and **B1** to determine the button's texts.

Use **L0** and **L1** to determine the texts to be displayed.

NOBG eliminates the button's surface and the display is visualized directly on the background.

BSWAP is used to switch between the states of the buttons: display of subsequent state (standard display) or display of the current state.

LSWAP is used to switch between the states of the display: display of subsequent state (standard display) or display of the current state.

Using **LOGIC**, LUA functions can be activated or manually incorporated in a LUA syntax-based logical function.

RDRQ sent a read request at start-up for the used widgets. This parameter only works when Communication Address and Receive Flag are set.

If "Use PIN" is selected, the default master password will be used in case **PIN** is not set. Using **PIN**, an individual password can be assigned.

AL/AH can only be used on alarm page. They serve as a limit setting the temporal point from which an alarm is detected.

Examples	Element Name; Format
	1Bit-P; B0=AUS; B1=AN; IMGSET=light;
	1Bit-P; L0=AUS; L1=AN; IMGSET=light;
	1Bit-P; IMGSET=light; BSWAP;
	1Bit-P; IMGSET=light;

2.4.7 1-Bit-Value-Pushbutton

ETS Objects		
Range of values	0/1	
Input	-	-
Output	Value	1 Bit
	Value B	1 Bit

Format	
IMG	Choosing an image
PRESS	Value that will be sent when pressing button
RELEASE	Value that will be sent when releasing button
LABEL	Text default for button
NOBG	No button background
JUMP	Command to jump to any side
LOGIC	Function call or direct incorporation of a logical function
LOGICR	Function call or direct incorporation of a logical function
PIN	In case "Use PIN" is selected, an individual password can be assigned using PIN

Simple button element to send a 1-bit value 0/1.

Using **LABEL**, you can define the text, or else an image using **IMG**, on the button.

PRESS determines the value that will be sent when pressing the button.

RELEASE determines the value that will be sent when releasing the button.

NOBG eliminates the button's surface and the display is visualized directly on the background.

Using **LOGIC**, LUA functions can be activated or manually incorporated in a LUA syntax-based logical function which is triggered when pressing the button.

Using **LOGICR**, LUA functions can be activated or manually incorporated in a LUA syntax-based logical function which is triggered when releasing the button.

If "Use PIN" is selected, the default master password will be used in case **PIN** is not set. Using **PIN**, an individual password can be assigned.

Examples	Element Name; Format
	1Bit; PRESS=0; LABEL=AUS;
	1Bit; PRESS=1; IMG=bell_b_on;
	1Bit; RELEASE=1; LABEL=EIN;
	1Bit; RELEASE=0; IMG=sound_b_off;



2.4.8 1-Bit-Timer-Profile

ETS Objects		
Range of values	0/1	
Input	-	-
Output	Profile	1 Bit
Input/Output	Profile Enable	1 Bit

Format	
W	Determines width of display's surface
L0	Text default for display on "0"
L1	Text default for display on "1"
IMG	Choosing an image
OVRTO	Determines the time (in minutes) until manual settings are overwritten
NOBG	No button background
RDRQ	Read Request
PIN	In case "Use PIN" is selected, an individual password can be assigned using PIN
PPIN	In case "Use PIN" is selected, an individual password for the secondary function can be assigned using PPIN

Complex element to send a 1-bit value 0/1 in a set time allowance.

W (in Pixel) determines the width of the display's surface. Use **L0** and **L1** to determine the texts to be displayed.



OVRTO determines the span of time, after which the settings made manually by the user are overwritten by the values set in the time table. (in minutes)

NOBG eliminates the button's surface and the display is visualized directly on the background.

Mit **RDRQ** werden bei Spannungswiederkehr die aktuellen Werte gelesen. Jedoch nur die Werte, die mit Adressen verknüpft und die entsprechenden Flags gesetzt sind.

If "Use PIN" is selected, the default master password will be used in case **PIN** is not set. Using **PIN**, an individual password can be assigned.

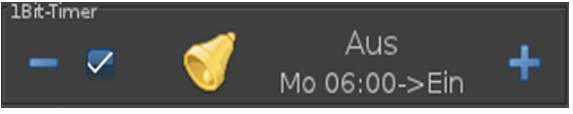
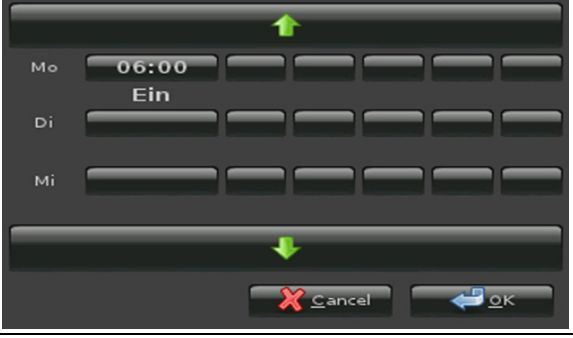
In case "Use PIN" is selected, an individual password can be assigned using **PPIN**, which protects the secondary functions of this object.

Examples	Element Name; Format
	<p>1Bit-Timer; IMG=bell_b_on.png; NOBG; OVRTO=1;</p>
	<p>Pressing the options button will open a dialog box where time allowances can be set, according to which the ETS object is then controlled.</p>
	<p>It is possible to determine up to 6 times for each weekday, at which freely selectable values out of the object value range can be sent.</p>

2.4.9 1-bit-Quad-ON/OFF-Status/Toggle-Text

ETS Objects	
Range of values	0/1
Input/Output	4x IO Switching 4x 1 Bit

Format	
W	Determines width of display's surface
LABELS	Labeling of buttons
N	Number of buttons displayed
NOBG	No button background
ALARM	Occurs when the transition from "0" to "1".
RDRQ	Read Request
PIN	In case "Use PIN" is selected, an individual password can be assigned using PIN

Simple element to send/receive 4x 1-bit values 0/1.

W (in Pixel) determines the width of the button's surface.

LABELS determines the button's labels.



N determines how many buttons are displayed. (A maximum of 4)

NOBG eliminates the button's surface and the display is visualized directly on the background.

ALARM is triggered during the transition from "0" to "1". All other bits are locked for the alarm function. The alarm can only be cleared by triggering bit.

RDRQ sent a read request at start-up for the used widgets. This parameter only works when Communication Address and Receive Flag are set.

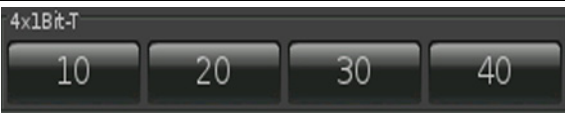
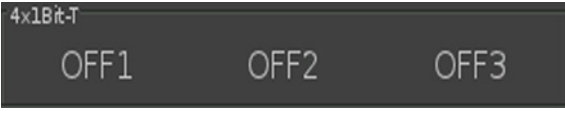
If "Use PIN" is selected, the default master password will be used in case **PIN** is not set. Using **PIN**, an individual password can be assigned.



Examples	Element Name; Format
	4x1Bit-T; LABELS=10,11,20,21,30,31,40,41;
	4x1Bit-T; LABELS=OFF1,ON1,OFF2,ON2,OFF3,ON3; N=3; NOBG;
	4x1Bit-T; LABELS=OFF1,ON1,OFF2,ON2; N=2; ALARM;



2.4.10 1-bit-Quad-ON/OFF-Status/Toggle-Picture

ETS Objects	
Range of values	0/1
Input/Output	4x IO Switching 4x 1 Bit
Format	
W	Determines width of display's surface
IMGSETS	Choosing set of images
N	Number of buttons displayed
NOBG	No button background
ALARM	Occurs when the transition from "0" to "1".
RDRQ	Read Request
PIN	In case "Use PIN" is selected, an individual password can be assigned using PIN

Simple element to send/receive 4x 1-bit values 0/1.
W (in Pixel) determines the width of the button's surface.
 Use **IMGSETS** to chose the set of images you want to use.
N determines how many buttons are displayed.
 (A maximum of 4)
NOBG eliminates the button's surface and the display is visualized directly on the background.
ALARM is triggered during the transition from "0" to "1". All other bits are locked for the alarm function. The alarm can only be cleared by triggering bit.
RDRQ sent a read request at start-up for the used widgets. This parameter only works when Communication Address and Receive Flag are set.
 If "Use PIN" is selected, the default master password will be used in case **PIN** is not set. Using **PIN**, an individual password can be assigned.

Examples	Element Name; Format
<p>4x1Bit-P</p> 	<p>4x1Bit-P; IMGSETS=light;</p>
<p>4x1Bit-P</p> 	<p>4x1Bit-P; IMGSETS=light,sound,dnd; N=3; NOBG;</p>
<p>4x1Bit-P</p> 	<p>4x1Bit-P; IMGSETS=window,door; N=2; ALARM;</p>



2.4.11 1-bit-Quad-Value-Pushbutton-Text

ETS Objects	
Range of values	1
Output	4x Switching 4x 1 Bit

Format	
W	Determines width of display's surface
LABELS	Labeling of buttons
N	Number of buttons displayed
NOBG	No button background
PRESS	Value that will be sent when pressing button
PIN	In case "Use PIN" is selected, an individual password can be assigned using PIN

Simple element to send 4x 1-bit values "1".

W (in Pixel) determines the width of the button's surface.



LABELS determines the button's labels.

N determines how many buttons are displayed. (A maximum of 4)

NOBG eliminates the button's surface and the display is visualized directly on the background.

PRESS indicates which logic state is transmitted when pressing the button.

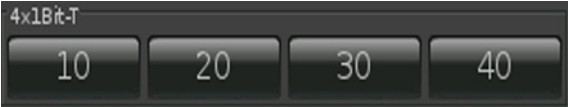
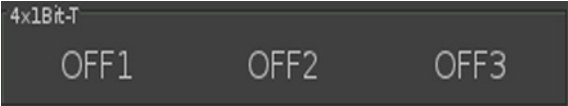
If "Use PIN" is selected, the default master password will be used in case **PIN** is not set. Using **PIN**, an individual password can be assigned.

Examples	Element Name; Format
	4x1Bit-T; LABELS=10,11,20,21,30,31,40,41; PRESS=1010;
	4x1Bit-T; LABELS=OFF1,ON1,OFF2,ON2,OFF3,ON3; N=3; NOBG;
	4x1Bit-T; LABELS=OFF1,ON1,OFF2,ON2; N=2; PRESS=01;





2.4.12 1-bit-Quad-Value-Pushbutton-Picture

ETS Objects	
Range of values	1
Output	4x Switching 4x 1 Bit

Format	
W	Determines width of display's surface
IMGSETS	Choosing set of images
N	Number of buttons displayed
NOBG	No button background
PRESS	Value that will be sent when pressing button
PIN	In case "Use PIN" is selected, an individual password can be assigned using PIN

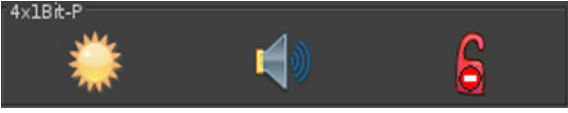









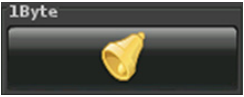

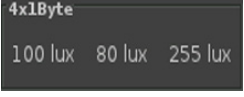

<p>Simple element to send 4x 1-bit values "1".</p> <p>W (in Pixel) determines the width of the button's surface.</p> <p>Use IMGSETS to chose the images you want to use. (In case sets of images are chosen only the ON images will be used)</p> <p>N determines how many buttons are displayed. (A maximum of 4)</p> <p>NOBG eliminates the button's surface and the display is visualized directly on the background.</p> <p>PRESS indicates which logic state is transmitted when pressing the button.</p> <p>If "Use PIN" is selected, the default master password will be used in case PIN is not set. Using PIN, an individual password can be assigned.</p>

Examples	Element Name; Format
<p>4x1Bit-P</p> 	<p>4x1Bit-P; IMGSETS=light; PRESS=1010;</p>
<p>4x1Bit-P</p> 	<p>4x1Bit-P; IMGSETS=light,sound,dnd; N=3; NOBG;</p>
<p>4x1Bit-P</p> 	<p>4x1Bit-P; IMGSETS=window,door; N=2; PRESS=01;</p>

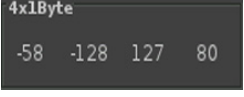

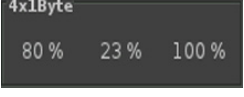
2.5 Overview 1-Byte Elements

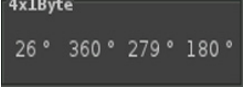
Image	Element Number	Element Type	Details Page
	Range of Values	Format	
	10	1-Byte-Value-Text-Button 0 .. 255	
	0 .. 255	W,B-,B+,PF,STEPS,MIN,MAX,AL,AH,NOBG,REP,RDRQ,PIN	
	11	1-Byte-Value-Picture-Button 0 .. 255	
	0 .. 255	W,PF,IMGSET,STEPS,MIN,MAX,AL,AH,NOBG,REP,IMGVAL,RDRQ,PIN	
	12	1-Byte-Value-Slider 0 .. 255	
	0 .. 255	W,PF,IMGSET,STEPS,MIN,MAX,AL,AH,NOBG,REP,RDRQ,PIN	
	13	1-Byte-Value-Text-Button -128 .. 127	
	-128 .. 127	W,B-,B+,PF,STEPS,MIN,MAX,AL,AH,NOBG,REP,RDRQ,PIN	
	14	1-Byte-Value-Picture-Button -128 .. 127	
	-128 .. 127	W,PF,IMGSET,STEPS,MIN,MAX,AL,AH,NOBG,REP,IMGVAL,RDRQ,PIN	
	15	1-Byte-Value-Slider -128 .. 127	
	-128 .. 127	W,PF,IMGSET,STEPS,MIN,MAX,AL,AH,NOBG,REP,RDRQ,PIN	
	16	1-Byte-Value-Text-Button 0 .. 100%	
	0 .. 255	W,B-,B+,PF,STEPS,MIN,MAX,AL,AH,NOBG,REP,RDRQ,PIN	
	17	1-Byte-Value-Picture-Button 0 .. 100%	
	0 .. 255	W,PF,IMGSET,STEPS,MIN,MAX,AL,AH,NOBG,REP,IMGVAL,RDRQ,PIN	
	18	1-Byte-Value-Slider 0 .. 100%	
	0 .. 255	W,PF,IMGSET,STEPS,MIN,MAX,AL,AH,NOBG,REP,RDRQ,PIN	
	19	1-Byte-Value-Text-Button 0 .. 360°	
	0 .. 255	W,B-,B+,PF,STEPS,MIN,MAX,AL,AH,NOBG,REP,RDRQ,PIN	
	20	1-Byte-Value-Picture-Button 0 .. 360°	
	0 .. 255	W,PF,IMGSET,STEPS,MIN,MAX,AL,AH,NOBG,REP,IMGVAL,RDRQ,PIN	
	21	1-Byte-Value-Slider 0 .. 360°	
	0 .. 255	W,PF,IMGSET,STEPS,MIN,MAX,AL,AH,NOBG,REP,RDRQ,PIN	

Image	Element Number	Element Type	Details
	Range of Values	Format	Page
	41	1-Byte-Value-Pushbutton	 38
	0 .. 255	IMG,PRESS,RELEASE,LABEL,NOBG,JUMP,LOGIC,LOGICR,PIN	
	63	1-Byte-Timer-Profile 0 .. 100%	 39
	0 .. 255	W,PF,MIN,MAX,STEP,OVRTO,NOBG,IMG,RDRQ,PIN,PPIN	
	64	1-Byte-Timer-Profile 0 .. 255	 40
	0 .. 255	W,MIN,MAX,STEP,OVRTO,NOBG,IMG,RDRQ,PIN,PPIN	
	89	1-Byte-Quad-Value/Change 0 .. 255	 41
	4x (0 .. 255)	W,PF,N,RDRQ	
	90	1-Byte-Quad-Value/Change -128 .. 127	 42
	4x (-128 .. 127)	W,PF,N,RDRQ	
	91	1-Byte-Quad-Value/Change 0 .. 100%	 43
	4x (0 .. 255)	W,PF,N,RDRQ	
	92	1-Byte-Quad-Value/Change 0 .. 360°	 44
	4x (0 .. 255)	W,PF,N,RDRQ	



2.5.1 1-Byte-Value-Text-Button 0 .. 255

ETS Objects		
Range of values	0 .. 255	
Input	Feedback	1 Byte
Output	Switching	1 Byte

Format	
W	Determines width of button's surface
B+	Text default for button on incrementing
B-	Text default for button on decrementing
NOBG	No button background
PF	Declaration of the unit
STEPS	Setting step quantity
MIN	Default setting of lower limit
MAX	Default setting of upper limit
REP	Setting repetition rate
RDRQ	Read Request
PIN	In case "Use PIN" is selected, an individual password can be assigned using PIN
AL	Alarm lower limit ONLY ON ALARM PAGE
AH	Alarm upper limit ONLY ON ALARM PAGE

Simple circuit element to send/receive a 1-byte value 0 .. 255.

Set the displayed texts on the buttons using **B-** and **B+**. **NOBG** eliminates the button's surface and the display is visualized directly on the background.

Using **PF**, a unit of measurement can be adjusted according to the measured value.

STEPS determines the step quantity for adjusting the value between MIN and MAX.

MIN determines lower limit.

MAX determines upper limit.

When pressing the buttons a little longer, **REP** sets the interval by which the values are sent (in milliseconds).

RDRQ sent a read request at start-up for the used widgets. This parameter only works when Communication Address and Receive Flag are set.

If "Use PIN" is selected, the default master password will be used in case **PIN** is not set. Using **PIN**, an individual password can be assigned.

AL/AH can only be used on alarm page. They serve as a limit setting the temporal point from which an alarm is detected.

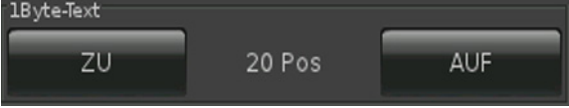
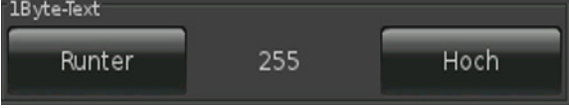
Examples	Element Name; Format
	1Byte-Text; PF=lux; B+=UP; B-=DOWN; MIN=50; MAX=200; STEPS=15; REP=1000;
	1Byte-Text; PF=Pos; B+=AUF; B-=ZU; MIN=20; MAX=100; STEPS=16; REP=500;
	1Byte-Text;

2.5.2 1-Byte-Value-Picture-Button 0 .. 255

ETS Objects		
Range of values	0 .. 255	
Input	Feedback	1 Byte
Output	Switching	1 Byte

Format	
W	Determines width of button's surface
IMGSET	Choosing set of images
NOBG	No button background
PF	Declaration of the unit
STEPS	Setting step quantity
MIN	Default setting of lower limit
MAX	Default setting of upper limit
REP	Setting repetition rate
IMGVAL	measured value-oriented image incorporation
RDRQ	Read Request
PIN	In case "Use PIN" is selected, an individual password can be assigned using PIN
AL	Alarm lower limit ONLY ON ALARM PAGE
AH	Alarm upper limit ONLY ON ALARM PAGE

Simple circuit element to send/receive a 1-byte value 0 .. 255.

Use **IMGSET** to choose the set of images you want to use.

NOBG eliminates the button's surface and the display is visualized directly on the background.

Using **PF**, a unit of measurement can be adjusted according to the measured value.

STEPS determines the step quantity for adjusting the value between MIN and MAX.

MIN determines lower limit.

MAX determines upper limit.

When pressing the buttons a little longer, **REP** sets the interval by which the values are sent. (in milliseconds)

Use **IMGVAL** to visualize the measured value. The labeling of the images limits the choice. (see chapter 8, **User-defined features**)

RDRQ sent a read request at start-up for the used widgets. This parameter only works when Communication Address and Receive Flag are set.

If "Use PIN" is selected, the default master password will be used in case **PIN** is not set. Using **PIN**, an individual password can be assigned.

AL/AH can only be used on alarm page. They serve as a limit setting the temporal point from which an alarm is detected.



>

>>

<<

<

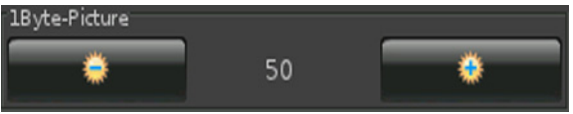
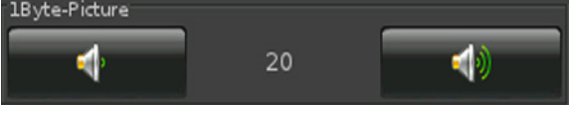
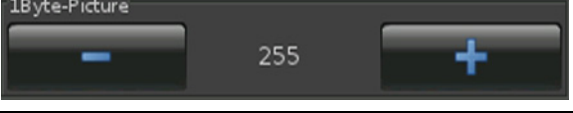
A

Examples	Element Name; Format
	1Byte-Picture; IMGSET=light; MIN=50; MAX=200; STEPS=15; REP=1000;
	1Byte-Picture; IMGSET=volume; MIN=20; MAX=100; STEPS=16; REP=500;
	1Byte-Picture;
	Here, the graphics have to be adjusted in advance e.g. IMGVAL=ampel;

2.5.3 1-Byte-Value-Slider 0 .. 255

ETS Objects		
Range of values	0 .. 255	
Input	Feedback	1 Byte
Output	Switching	1 Byte

Format	
W	Determines width of button's surface
IMGSET	Choosing set of images
NOBG	No button background
PF	Declaration of the unit
STEPS	Setting step quantity
MIN	Default setting of lower limit
MAX	Default setting of upper limit
REP	Setting repetition rate
RDRQ	Read Request
PIN	In case "Use PIN" is selected, an individual password can be assigned using PIN
AL	Alarm lower limit ONLY ON ALARM PAGE
AH	Alarm upper limit ONLY ON ALARM PAGE

Simple circuit element to send/receive a 1-byte value 0 .. 255.

Use **IMGSET** to choose the set of images you want to use.

NOBG eliminates the button's surface and the display is visualized directly on the background.

Using **PF**, a unit of measurement can be adjusted according to the measured value.

STEPS determines the step quantity for adjusting the value between MIN and MAX.

MIN determines lower limit.



MAX determines upper limit.

When pressing the buttons a little longer, **REP** sets the interval by which the values are sent. (in milliseconds)

RDRQ sent a read request at start-up for the used widgets. This parameter only works when Communication Address and Receive Flag are set.

If "Use PIN" is selected, the default master password will be used in case **PIN** is not set. Using **PIN**, an individual password can be assigned.

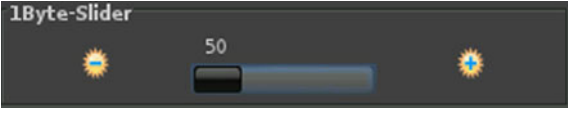
AL/AH can only be used on alarm page. They serve as a limit setting the temporal point from which an alarm is detected.

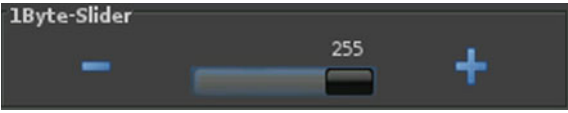
Examples	Element Name; Format
	1Byte-Slider; IMGSET=light; MIN=50; MAX=200; STEPS=15; REP=1000;
	1Byte-Slider; IMGSET=volume; MIN=20; MAX=100; STEPS=16; REP=500;
	1Byte-Slider;

2.5.4 1-Byte-Value-Text-Button -128 .. 127

ETS objects		
Range of values	-128 .. 127	
Input	Feedback	1 Byte
Output	Switching	1 Byte

Format	
W	Determines width of button's surface
B+	Text default for button on incrementing
B-	Text default for button on decrementing
NOBG	No button background
PF	Declaration of the unit
STEPS	Setting step quantity
MIN	Default setting of lower limit
MAX	Default setting of upper limit
REP	Setting repetition rate
RDRQ	Read Request
PIN	In case "Use PIN" is selected, an individual password can be assigned using PIN
AL	Alarm lower limit ONLY ON ALARM PAGE
AH	Alarm upper limit ONLY ON ALARM PAGE

Simple circuit element to send/receive a 1-byte value -128 .. 127.

Set the displayed texts on the buttons using B- and B+.

NOBG eliminates the button's surface and the display is visualized directly on the background.

Using **PF**, a unit of measurement can be adjusted according to the measured value.

STEPS determines the step quantity for adjusting the value between MIN and MAX.

MIN determines lower limit.

MAX determines upper limit.

When pressing the buttons a little longer, **REP** sets the interval by which the values are sent. (in milliseconds)

RDRQ sent a read request at start-up for the used widgets. This parameter only works when Communication Address and Receive Flag are set.

If "Use PIN" is selected, the default master password will be used in case **PIN** is not set. Using **PIN**, an individual password can be assigned.

AL/AH can only be used on alarm page. They serve as a limit setting the temporal point from which an alarm is detected.

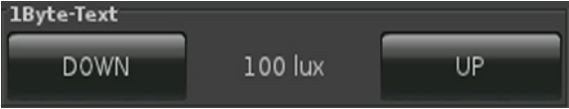
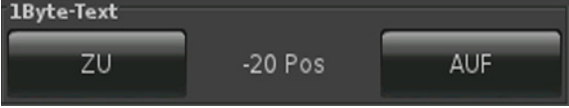
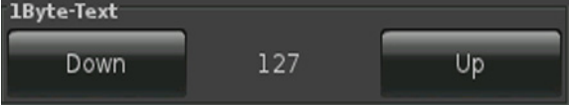
Examples	Element Name; Format
	1Byte-Text; PF=lux; B+=UP; B-=DOWN; MIN=-50; MAX=100; STEPS=15; REP=1000;
	1Byte-Text; PF=Pos; B+=AUF; B-=ZU; MIN=-20; MAX=100; STEPS=16; REP=500;
	1Byte-Text;

2.5.5 1-Byte-Value-Picture-Button -128 .. 127

ETS Objects		
Range of values	-128 .. 127	
Input	Feedback	1 Byte
Output	Switching	1 Byte
Format		
W	Determines width of button's surface	
IMGSET	Choosing set of images	
NOBG	No button background	
PF	Declaration of the unit	
STEPS	Setting step quantity	
MIN	Default setting of lower limit	
MAX	Default setting of upper limit	
REP	Setting repetition rate	
IMGVAL	measured value-oriented image incorporation	
RDRQ	Read Request	
PIN	In case "Use PIN" is selected, an individual password can be assigned using PIN	
AL	Alarm lower limit ONLY ON ALARM PAGE	
AH	Alarm upper limit ONLY ON ALARM PAGE	

Simple circuit element to send/receive a 1-byte value -128 .. 127.

Use **IMGSET** to choose the set of images you want to use.

NOBG eliminates the button's surface and the display is visualized directly on the background.

Using **PF**, a unit of measurement can be adjusted according to the measured value.

STEPS determines the step quantity for adjusting the value between MIN and MAX.

MIN determines lower limit.

MAX determines upper limit.



When pressing the buttons a little longer, **REP** sets the interval by which the values are sent. (in milliseconds)

Use **IMGVAL** to visualize the measured value. The labeling of the images limits the choice. (see chapter 8, **User-defined features**)

RDRQ sent a read request at start-up for the used widgets. This parameter only works when Communication Address and Receive Flag are set.

If "Use PIN" is selected, the default master password will be used in case **PIN** is not set. Using **PIN**, an individual password can be assigned.

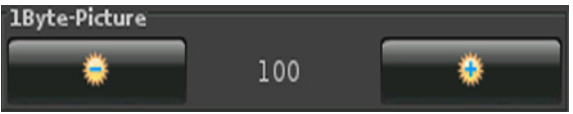
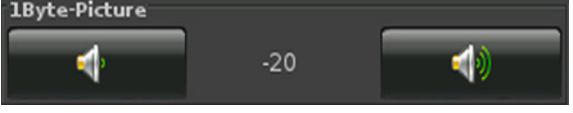
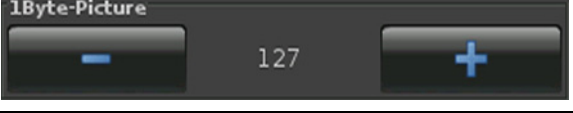
AL/AH can only be used on alarm page. They serve as a limit setting the temporal point from which an alarm is detected.

Examples	Element Name; Format
	1Byte-Picture; IMGSET=light; MIN=-50; MAX=100; STEPS=15; REP=1000;
	1Byte-Picture; IMGSET=volume; MIN=-20; MAX=100; STEPS=16; REP=500;
	1Byte-Picture;
	Here, the graphics have to be adjusted in advance e.g. IMGVAL=ampel;

2.5.6 1-Byte-Value-Slider -128 .. 127

ETS Objects		
Range of values	-128 .. 127	
Input	Feedback	1 Byte
Output	Switching	1 Byte

Format	
W	Determines width of button's surface
IMGSET	Choosing set of images
NOBG	No button background
PF	Declaration of the unit
STEPS	Setting step quantity
MIN	Default setting of lower limit
MAX	Default setting of upper limit
REP	Setting repetition rate
RDRQ	Read Request
PIN	In case "Use PIN" is selected, an individual password can be assigned using PIN
AL	Alarm lower limit ONLY ON ALARM PAGE
AH	Alarm upper limit ONLY ON ALARM PAGE

Simple circuit element to send/receive a 1-byte value -128 .. 127.

Use **IMGSET** to choose the set of images you want to use.

NOBG eliminates the button's surface and the display is visualized directly on the background.

Using **PF**, a unit of measurement can be adjusted according to the measured value.

STEPS determines the step quantity for adjusting the value between MIN and MAX.

MIN determines lower limit.

MAX determines upper limit.

When pressing the buttons a little longer, **REP** sets the interval by which the values are sent. (in milliseconds)

RDRQ sent a read request at start-up for the used widgets. This parameter only works when Communication Address and Receive Flag are set.

If "Use PIN" is selected, the default master password will be used in case **PIN** is not set. Using **PIN**, an individual password can be assigned.

AL/AH can only be used on alarm page. They serve as a limit setting the temporal point from which an alarm is detected.

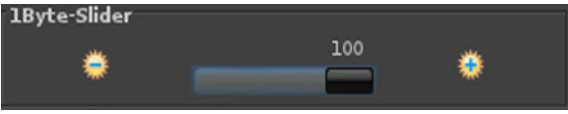
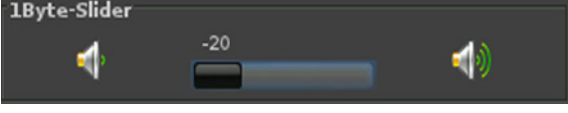
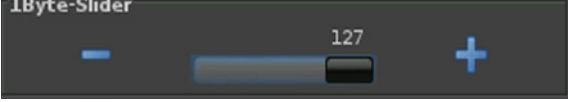
Examples	Element Name; Format
	1Byte-Slider; IMGSET=light; MIN=-50; MAX=100; STEPS=15; REP=1000;
	1Byte-Slider; IMGSET=volume; MIN=-20; MAX=100; STEPS=16; REP=500;
	1Byte-Slider;

2.5.7 1-Byte-Value-Text-Button 0 .. 100%

ETS Objects		
Range of values	0 .. 255	
Input	Feedback	1 Byte
Output	Switching	1 Byte

Format	
W	Determines width of button's surface
B+	Text default for button on incrementing
B-	Text default for button on decrementing
NOBG	No button background
PF	Declaration of the unit
STEPS	Setting step quantity
MIN	Default setting of lower limit
MAX	Default setting of upper limit
REP	Setting repetition rate
RDRQ	Read Request
PIN	In case "Use PIN" is selected, an individual password can be assigned using PIN
AL	Alarm lower limit ONLY ON ALARM PAGE
AH	Alarm upper limit ONLY ON ALARM PAGE

Simple circuit element to send/receive a 1-byte value 0 .. 255.

Set the displayed texts on the buttons using **B-** and **B+**.

NOBG eliminates the button's surface and the display is visualized directly on the background.

Using **PF**, a unit of measurement can be adjusted according to the measured value.

STEPS determines the step quantity for adjusting the value between MIN and MAX.

MIN determines lower limit.

MAX determines upper limit.

When pressing the buttons a little longer, **REP** sets the interval by which the values are sent. (in milliseconds)

RDRQ sent a read request at start-up for the used widgets. This parameter only works when Communication Address and Receive Flag are set.

If "Use PIN" is selected, the default master password will be used in case **PIN** is not set. Using **PIN**, an individual password can be assigned.

AL/AH can only be used on alarm page. They serve as a limit setting the temporal point from which an alarm is detected.

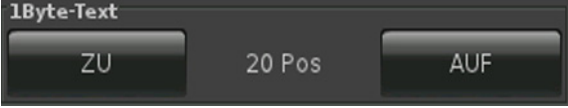
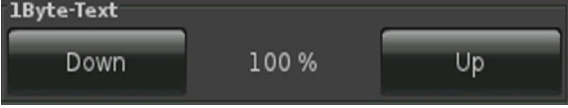
Examples	Element Name; Format
	1Byte-Text; PF=lux; B+=UP; B-=DOWN; MIN=50; MAX=80; STEPS=15; REP=1000;
	1Byte-Text; PF=Pos; B+=AUF; B-=ZU; MIN=20; MAX=70; STEPS=16; REP=500;
	1Byte-Text;

2.5.8 1-Byte-Value-Picture-Button 0 .. 100%

ETS Objects		
Range of values	0 .. 255	
Input	Feedback	1 Byte
Output	Switching	1 Byte

Format	
W	Determines width of button's surface
IMGSET	Choosing set of images
NOBG	No button background
PF	Declaration of the unit
STEPS	Setting step quantity
MIN	Default setting of lower limit
MAX	Default setting of upper limit
REP	Setting repetition rate
IMGVAL	measured value-oriented image incorporation
RDRQ	Read Request
PIN	In case "Use PIN" is selected, an individual password can be assigned using PIN
AL	Alarm lower limit ONLY ON ALARM PAGE
AH	Alarm upper limit ONLY ON ALARM PAGE

Simple circuit element to send/receive a 1-byte value 0 .. 255.

Use **IMGSET** to choose the set of images you want to use.

NOBG eliminates the button's surface and the display is visualized directly on the background.

Using **PF**, a unit of measurement can be adjusted according to the measured value.

STEPS determines the step quantity for adjusting the value between MIN and MAX.

MIN determines lower limit.

MAX determines upper limit.



When pressing the buttons a little longer, **REP** sets the interval by which the values are sent. (in milliseconds)

Use **IMGVAL** to visualize the measured value. The labeling of the images limits the choice. (see chapter 8, **User-defined features**)

RDRQ sent a read request at start-up for the used widgets. This parameter only works when Communication Address and Receive Flag are set.

If "Use PIN" is selected, the default master password will be used in case **PIN** is not set. Using **PIN**, an individual password can be assigned.

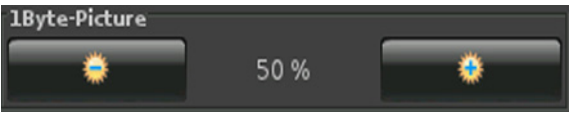
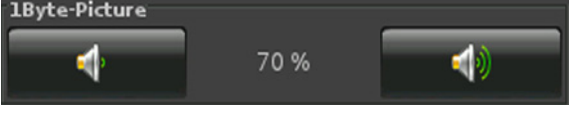
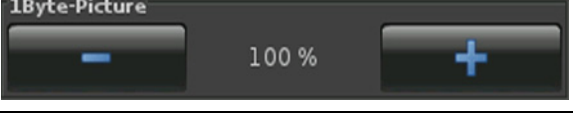
AL/AH can only be used on alarm page. They serve as a limit setting the temporal point from which an alarm is detected.

Examples	Element Name; Format
	1Byte-Picture; IMGSET=light; MIN=50; MAX=80; STEPS=15; REP=1000;
	1Byte-Picture; IMGSET=volume; MIN=20; MAX=70; STEPS=16; REP=500;
	1Byte-Picture;
	Here, the graphics have to be adjusted in advance e.g. IMGVAL=ampel;

2.5.9 1-Byte-Value-Slider 0 .. 100%

ETS Objects		
Range of values	0 .. 255	
Input	Feedback	1 Byte
Output	Switching	1 Byte

Format	
W	Determines width of button's surface
IMGSET	Choosing set of images
NOBG	No button background
PF	Declaration of the unit
STEPS	Setting step quantity
MIN	Default setting of lower limit
MAX	Default setting of upper limit
REP	Setting repetition rate
RDRQ	Read Request
PIN	In case "Use PIN" is selected, an individual password can be assigned using PIN
AL	Alarm lower limit ONLY ON ALARM PAGE
AH	Alarm upper limit ONLY ON ALARM PAGE

Simple circuit element to send/receive a 1-byte value 0 .. 255.

Use **IMGSET** to choose the set of images you want to use.

NOBG eliminates the button's surface and the display is visualized directly on the background.

Using **PF**, a unit of measurement can be adjusted according to the measured value.

STEPS determines the step quantity for adjusting the value between MIN and MAX.

MIN determines lower limit.

MAX determines upper limit.

When pressing the buttons a little longer, **REP** sets the interval by which the values are sent. (in milliseconds)

RDRQ sent a read request at start-up for the used widgets. This parameter only works when Communication Address and Receive Flag are set.

If "Use PIN" is selected, the default master password will be used in case **PIN** is not set. Using **PIN**, an individual password can be assigned.

AL/AH can only be used on alarm page. They serve as a limit setting the temporal point from which an alarm is detected.

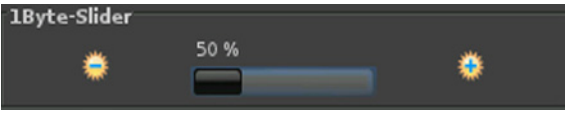
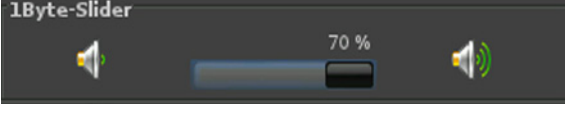
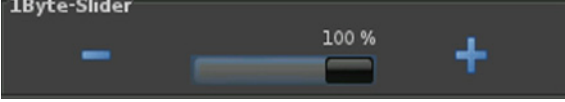
Examples	Element Name; Format
	1Byte-Slider; IMGSET=light; MIN=50; MAX=80; STEPS=15; REP=1000;
	1Byte-Slider; IMGSET=volume; MIN=20; MAX=70; STEPS=16; REP=500;
	1Byte-Slider;

2.5.10 1-Byte-Value-Text-Button 0 .. 360°

ETS Objects		
Range of values	0 .. 255	
Input	Feedback	1 Byte
Output	Switching	1 Byte

Format	
W	Determines width of button's surface
B+	Text default for button on incrementing
B-	Text default for button on decrementing
NOBG	No button background
PF	Declaration of the unit
STEPS	Setting step quantity
MIN	Default setting of lower limit
MAX	Default setting of upper limit
REP	Setting repetition rate
RDRQ	Read Request
PIN	In case "Use PIN" is selected, an individual password can be assigned using PIN
AL	Alarm lower limit ONLY ON ALARM PAGE
AH	Alarm upper limit ONLY ON ALARM PAGE

Simple circuit element to send/receive a 1-byte value 0 .. 255.

Set the displayed texts on the buttons using **B-** and **B+**. **NOBG** eliminates the button's surface and the display is visualized directly on the background.

Using **PF**, a unit of measurement can be adjusted according to the measured value.

STEPS determines the step quantity for adjusting the value between MIN and MAX.

MIN determines lower limit.

MAX determines upper limit.

When pressing the buttons a little longer, **REP** sets the interval by which the values are sent. (in milliseconds)

RDRQ sent a read request at start-up for the used widgets. This parameter only works when Communication Address and Receive Flag are set.

If "Use PIN" is selected, the default master password will be used in case **PIN** is not set. Using **PIN**, an individual password can be assigned.

AL/AH can only be used on alarm page. They serve as a limit setting the temporal point from which an alarm is detected.

Examples	Element Name; Format
	1Byte-Text; PF=lux; B+=UP; B-=DOWN; MIN=50; MAX=280; STEPS=15; REP=1000;
	1Byte-Text; PF=Pos; B+=AUF; B-=ZU; MIN=20; MAX=300; STEPS=16; REP=500;
	1Byte-Text;

2.5.11 1-Byte-Value-Picture-Button 0 .. 360°

ETS Objects		
Range of values	0 .. 255	
Input	Feedback	1 Byte
Output	Switching	1 Byte
Format		
W	Determines width of button's surface	
IMGSET	Choosing set of images	
NOBG	No button background	
PF	Declaration of the unit	
STEPS	Setting step quantity	
MIN	Default setting of lower limit	
MAX	Default setting of upper limit	
REP	Setting repetition rate	
IMGVAL	measured value-oriented image incorporation	
RDRQ	Read Request	
PIN	In case "Use PIN" is selected, an individual password can be assigned using PIN	
AL	Alarm lower limit ONLY ON ALARM PAGE	
AH	Alarm upper limit ONLY ON ALARM PAGE	

Simple circuit element to send/receive a 1-byte value 0 .. 255.

Use **IMGSET** to choose the set of images you want to use.

NOBG eliminates the button's surface and the display is visualized directly on the background.

Using **PF**, a unit of measurement can be adjusted according to the measured value.

STEPS determines the step quantity for adjusting the value between MIN and MAX.

MIN determines lower limit.

MAX determines upper limit.



When pressing the buttons a little longer, **REP** sets the interval by which the values are sent. (in milliseconds)

Use **IMGVAL** to visualize the measured value. The labeling of the images limits the choice. (see chapter 8, **User-defined features**)

RDRQ sent a read request at start-up for the used widgets. This parameter only works when Communication Address and Receive Flag are set.

If "Use PIN" is selected, the default master password will be used in case **PIN** is not set. Using **PIN**, an individual password can be assigned.

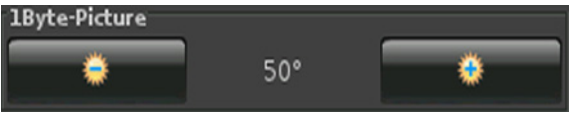
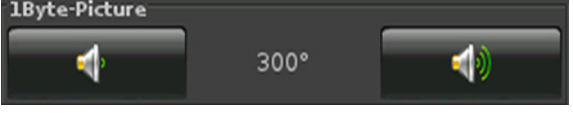
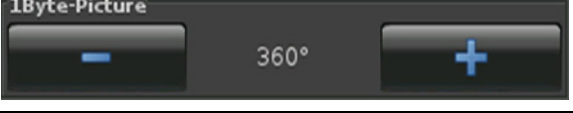
AL/AH can only be used on alarm page. They serve as a limit setting the temporal point from which an alarm is detected.

Examples	Element Name; Format
	1Byte-Picture; IMGSET=light; MIN=50; MAX=280; STEPS=15; REP=1000;
	1Byte-Picture; IMGSET=volume; MIN=20; MAX=300; STEPS=16; REP=500;
	1Byte-Picture;
	Here, the graphics have to be adjusted in advance e.g. IMGVAL=ampel;

2.5.12 1-Byte-Value-Slider 0 .. 360°

ETS Objects		
Range of values	0 .. 255	
Input	Feedback	1 Byte
Output	Switching	1 Byte
Format		
W	Determines width of button's surface	
IMGSET	Choosing set of images	
NOBG	No button background	
PF	Declaration of the unit	
STEPS	Setting step quantity	
MIN	Default setting of lower limit	
MAX	Default setting of upper limit	
REP	Setting repetition rate	
RDRQ	Read Request	
PIN	In case "Use PIN" is selected, an individual password can be assigned using PIN	
AL	Alarm lower limit ONLY ON ALARM PAGE	
AH	Alarm upper limit ONLY ON ALARM PAGE	

Simple circuit element to send/receive a 1-byte value 0 .. 255.

Use **IMGSET** to choose the set of images you want to use.

NOBG eliminates the button's surface and the display is visualized directly on the background.

Using **PF**, a unit of measurement can be adjusted according to the measured value.

STEPS determines the step quantity for adjusting the value between MIN and MAX.

MIN determines lower limit.

MAX determines upper limit.

When pressing the buttons a little longer, **REP** sets the interval by which the values are sent. (in milliseconds)

RDRQ sent a read request at start-up for the used widgets. This parameter only works when Communication Address and Receive Flag are set.

If "Use PIN" is selected, the default master password will be used in case **PIN** is not set. Using **PIN**, an individual password can be assigned.

AL/AH can only be used on alarm page. They serve as a limit setting the temporal point from which an alarm is detected.

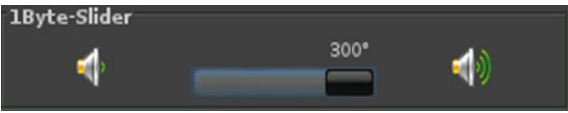
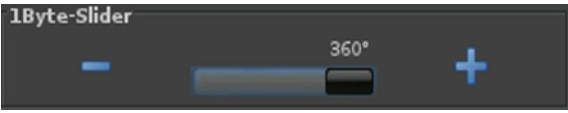
Examples	Element Name; Format
	1Byte-Slider; IMGSET=light; MIN=50; MAX=280; STEPS=15; REP=1000;
	1Byte-Slider; IMGSET=volume; MIN=20; MAX=300; STEPS=16; REP=500;
	1Byte-Slider;

2.5.13 1-Byte-Value-Pushbutton

ETS Objects		
Range of values	0 .. 255	
Input	-	-
Output	Value	1 Byte
	Value B	1 Byte

Format	
IMG	Choosing an image
PRESS	Value that will be sent when pressing button
RELEASE	Value that will be sent when releasing button
LABEL	Text default for button
NOBG	No button background
JUMP	Command to jump to any side
LOGIC	Function call or direct incorporation of a logical function
LOGICR	Function call or direct incorporation of a logical function
PIN	In case "Use PIN" is selected, an individual password can be assigned using PIN

Simple button element to send/receive a 1-byte value 0 .. 255.

Using **LABEL**, you can define the text, or else an image using **IMG**, on the button.

PRESS determines the value that will be sent when pressing the button.



RELEASE determines the value that will be sent when releasing the button.

NOBG eliminates the button's surface and the display is visualized directly on the background.

Using **LOGIC**, LUA functions can be activated or manually incorporated in a LUA syntax-based logical function which is triggered when pressing the button.

Using **LOGICR**, LUA functions can be activated or manually incorporated in a LUA syntax-based logical function which is triggered when releasing the button.

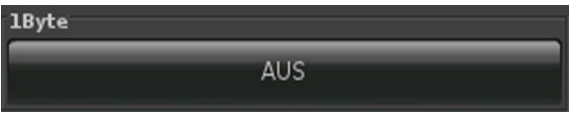
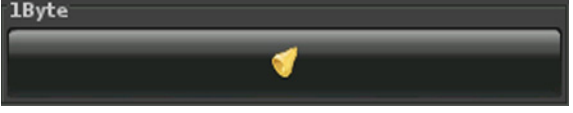
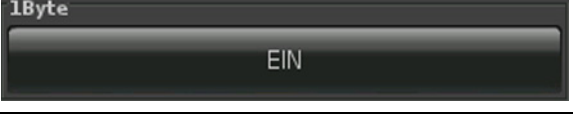
If "Use PIN" is selected, the default master password will be used in case **PIN** is not set. Using **PIN**, an individual password can be assigned.

Examples	Element Name; Format
	1Byte; PRESS=115; LABEL=AUS;
	1Byte; PRESS=112; IMG=bell_b_on;
	1Byte; RELEASE=71; LABEL=EIN;
	1Byte; RELEASE=0; IMG=sound_b_off;



2.5.14 1-Byte-Timer-Profile 0 .. 100%

ETS Objects		
Range of values	0 .. 255	
Input	-	-
Output	Profile	1 Byte
Input/Output	Profile Enable	1 Bit

Format	
W	Determines width of display's surface
IMG	Choosing an image
OVRTO	Determines the time (in minutes) until manual settings are overwritten
NOBG	No button background
STEP	Setting step size
MIN	Default setting of lower limit
MAX	Default setting of upper limit
RDRQ	Read Request
PIN	In case "Use PIN" is selected, an individual password can be assigned using PIN
PPIN	In case "Use PIN" is selected, an individual password for the secondary function can be assigned using PPIN

Complex element to send a 1-byte value 0 .. 255 in a set time allowance.

W (in Pixel) determines the width of the display's surface.

OVRTO determines the span of time, after which the settings made manually by the user are overwritten by the values set in the time table. (in minutes)

NOBG eliminates the button's surface and the display is visualized directly on the background.



STEP in this special case the step size is defined as described below.
STEP $\approx 2,55 \times$ step size in %
STEP is not given, step size set automatically to 1%.

MIN determines lower limit and **MAX** determines upper limit, in which 0 --> 0% and 255 --> 100%.

RDRQ sent a read request at start-up for the used widgets. This parameter only works when Communication Address and Receive Flag are set.

If "Use PIN" is selected, the default master password will be used in case **PIN** is not set. Using **PIN**, an individual password can be assigned.

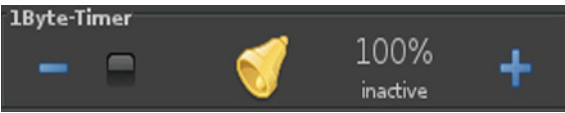
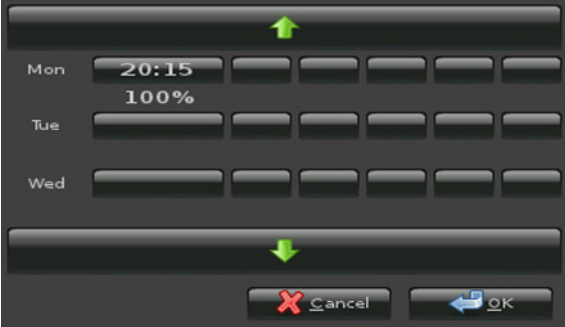
In case "Use PIN" is selected, an individual password can be assigned using **PPIN**, which protects the secondary functions of this object.

Examples	Element Name; Format
	<p>1Byte-Timer; IMG=bell_b_on.png; NOBG; OVRTO=1;</p>
	<p>Pressing the options button will open a dialog box where time allowances can be set, according to which the ETS object is then controlled.</p>
	<p>It is possible to determine up to 6 times for each weekday, at which freely selectable values out of the object value range can be sent.</p>

2.5.15 1-Byte-Timer-Profile 0 .. 255

ETS Objects		
Range of values	0 .. 255	
Input	-	-
Output	Profile	1 Byte
Input/Output	Profile Enable	1 Bit

Format	
W	Determines width of display's surface
IMG	Choosing an image
OVRTO	Determines the time (in minutes) until manual settings are overwritten
NOBG	No button background
STEP	Setting step size
MIN	Default setting of lower limit
MAX	Default setting of upper limit
RDRQ	Read Request
PIN	In case "Use PIN" is selected, an individual password can be assigned using PIN
PPIN	In case "Use PIN" is selected, an individual password for the secondary function can be assigned using PPIN

Complex element to send a 1-byte value 0 .. 255 in a set time allowance.

W (in Pixel) determines the width of the display's surface.

OVRTO determines the span of time, after which the settings made manually by the user are overwritten by the values set in the time table. (in minutes)

NOBG eliminates the button's surface and the display is visualized directly on the background.

STEP determines the step size for adjusting the value between MIN and MAX.



MIN determines lower limit.

MAX determines upper limit.

RDRQ sent a read request at start-up for the used widgets. This parameter only works when Communication Address and Receive Flag are set.

If "Use PIN" is selected, the default master password will be used in case **PIN** is not set. Using **PIN**, an individual password can be assigned.

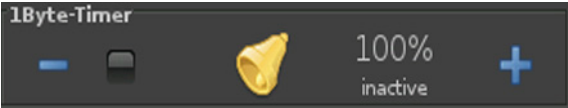
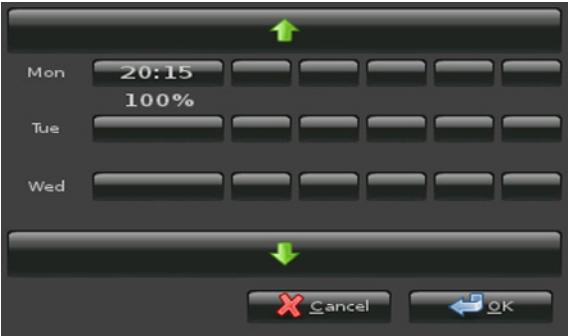
In case "Use PIN" is selected, an individual password can be assigned using **PPIN**, which protects the secondary functions of this object.

Examples	Element Name; Format
	<p>1Byte-Timer; IMG=bell_b_on.png; NOBG; OVRTO=1;</p>
	<p>Pressing the options button will open a dialog box where time allowances can be set, according to which the ETS object is then controlled.</p>
	<p>It is possible to determine up to 6 times for each weekday, at which freely selectable values out of the object value range can be sent.</p>

2.5.16 1-Byte-Quad-Value/Change 0 .. 255

ETS Objects	
Range of values	4x 0 .. 255
Input	4x Feedback 4x 1 Byte
Format	
W	Determines width of display's surface
PF	Declaration of the unit
N	Number of buttons displayed
RDRQ	Read Request

Simple element to receive 4x 1-byte values 0 .. 255.
W (in Pixel) determines the width of the button's surface.
N determines how many buttons are displayed.
(A maximum of 4)
Using **PF**, a unit of measurement can be adjusted according to the measured value.
RDRQ sent a read request at start-up for the used widgets.
This parameter only works when Communication Address and Receive Flag are set.

Examples	Element Name; Format
<div style="background-color: #333; color: #eee; padding: 5px;"> <p>4x1Byte</p> <p>100 lux 80 lux 255 lux</p> </div>	4x1Byte; N=3; PF=lux;

2.5.17 1-Byte-Quad-Value/Change -128 .. 127

ETS Objects	
Range of values	4x -128 .. 127
Input	4x Feedback 4x 1 Byte
Format	
W	Determines width of display's surface
PF	Declaration of the unit
N	Number of buttons displayed
RDRQ	Read Request

Simple element to receive 4x 1-byte values -128 .. 127.
W (in Pixel) determines the width of the button's surface.
N determines how many buttons are displayed.
(A maximum of 4)
Using **PF**, a unit of measurement can be adjusted according to the measured value.
RDRQ sent a read request at start-up for the used widgets.
This parameter only works when Communication Address and Receive Flag are set.

Examples	Element Name; Format
<div style="background-color: #333; color: #ccc; padding: 5px;"> <p>4x1Byte</p> <p style="text-align: center;">-58 -128 127 80</p> </div>	4x1Byte; N=4;

2.5.18 1-Byte-Quad-Value/Change 0 .. 100%

ETS Objects	
Range of values	4x 0 .. 255
Input	4x Feedback 4x 1 Byte

Format	
W	Determines width of display's surface
PF	Declaration of the unit
N	Number of buttons displayed
RDRQ	Read Request

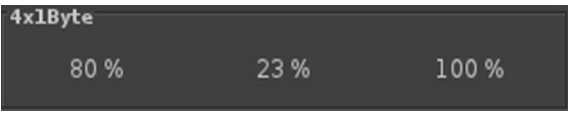
Examples	Element Name; Format
	4x1Byte; N=3; PF=%;

Simple element to receive 4x 1-byte values 0 .. 255.

W (in Pixel) determines the width of the button's surface.

N determines how many buttons are displayed.
(A maximum of 4)

Using **PF**, a unit of measurement can be adjusted according to the measured value.

RDRQ sent a read request at start-up for the used widgets.
This parameter only works when Communication Address and Receive Flag are set.

2.5.19 1-Byte-Quad-Value/Change 0 .. 360°

ETS Objects	
Range of values	4x 0 .. 255
Input	4x Feedback 4x 1 Byte
Format	
W	Determines width of display's surface
PF	Declaration of the unit
N	Number of buttons displayed
RDRQ	Read Request

Simple element to receive 4x 1-byte values 0 .. 255.
W (in Pixel) determines the width of the button's surface.
N determines how many buttons are displayed.
(A maximum of 4)
Using **PF**, a unit of measurement can be adjusted according to the measured value.
RDRQ sent a read request at start-up for the used widgets.
This parameter only works when Communication Address and Receive Flag are set.

Examples	Element Name; Format
<div style="background-color: #333; color: #fff; padding: 5px;"> <p>4x1Byte</p> <p>26 ° 360 ° 279 ° 180 °</p> </div>	4x1Byte; N=4; PF=°;

2.6 Overview 2-Byte Elements

Image	Element Number	Element Type	Details Page
	Range of Values	Format	
	22	2-Byte-Value-Text-Button 0 .. 65535	46
	0 .. 65535	W,B-,B+,PF,STEPS,MIN,MAX,AL,AH,NOBG,REP,RDRQ,PIN	
	23	2-Byte-Value-Picture-Button 0 .. 65535	47
	0 .. 65535	W,PF,IMGSET,STEPS,MIN,MAX,AL,AH,NOBG,REP,RDRQ,PIN	
	24	2-Byte-Value-Slider 0 .. 65535	48
	0 .. 65535	W,PF,IMGSET,STEPS,MIN,MAX,AL,AH,NOBG,REP,RDRQ,PIN	
	25	2-Byte-Value-Text-Button -32768 .. 32767	49
	-32768 .. 32787	W,B-,B+,PF,STEPS,MIN,MAX,AL,AH,NOBG,REP,RDRQ,PIN	
	26	2-Byte-Value-Picture-Button -32768 .. 32767	50
	-32768 .. 32787	W,PF,IMGSET,STEPS,MIN,MAX,AL,AH,NOBG,REP,RDRQ,PIN	
	27	2-Byte-Value-Slider -32768 .. 32767	51
	-32768 .. 32787	W,PF,IMGSET,STEPS,MIN,MAX,AL,AH,NOBG,REP,RDRQ,PIN	
	30	2-Byte-Float-Text-Button	52
	-671088.64 .. 670760,96	W,B-,B+,PF,STEPS,MIN,MAX,AL,AH,NOBG,REP,RDRQ,DC,PIN,*	
	31	2-Byte-Float-Picture-Button	53
	-671088.64 .. 670760,96	W,PF,IMGSET,STEPS,MIN,MAX,AL,AH,NOBG,REP,RDRQ,DC,PIN,*	
	32	2-Byte-Float-Slider	54
	-671088.64 .. 670760,96	W,PF,IMGSET,STEPS,MIN,MAX,AL,AH,NOBG,REP,RDRQ,DC,PIN,*	
	42	2-Byte-Value-Pushbutton	55
	0 .. 65535	IMG,PRESS,RELEASE,LABEL,NOBG,JUMP,LOGIC,LOGICR,PIN	
	43	2-Byte-Float-Value-Pushbutton	56
	-671088.64 .. 670760,96	IMG,PRESS,RELEASE,LABEL,NOBG,JUMP,LOGIC,LOGICR,PIN	
	66	2-Byte-Float-Timer-Profile	57
	-671088.64 .. 670760,96	W,PF,MIN,MAX,STEP,OVRTO,NOBG,IMG,RDRQ,PIN,PPIN	

2.6.1 2-Byte-Value-Text-Button 0 .. 65535

ETS Objects		
Range of values	0 .. 65535	
Input	Feedback	2 Byte
Output	Switching	2 Byte

Format	
W	Determines width of button's surface
B+	Text default for button on incrementing
B-	Text default for button on decrementing
NOBG	No button background
PF	Declaration of the unit
STEPS	Setting step quantity
MIN	Default setting of lower limit
MAX	Default setting of upper limit
REP	Setting repetition rate
RDRQ	Read Request
PIN	In case "Use PIN" is selected, an individual password can be assigned using PIN
AL	Alarm lower limit ONLY ON ALARM PAGE
AH	Alarm upper limit ONLY ON ALARM PAGE

Simple circuit element to send/receive a 2-byte value 0 .. 65535.

Use **B-** and **B+** to determine the button's texts.

NOBG eliminates the button's surface and the display is visualized directly on the background.

Using **PF**, a unit of measurement can be adjusted according to the measured value.

STEPS determines the step quantity for adjusting the value between MIN and MAX.

MIN determines lower limit.

MAX determines upper limit.

When pressing the buttons a little longer, **REP** sets the interval by which the values are sent. (in milliseconds)

RDRQ sent a read request at start-up for the used widgets. This parameter only works when Communication Address and Receive Flag are set.

If "Use PIN" is selected, the default master password will be used in case **PIN** is not set. Using **PIN**, an individual password can be assigned.

AL/AH can only be used on alarm page. They serve as a limit setting the temporal point from which an alarm is detected.

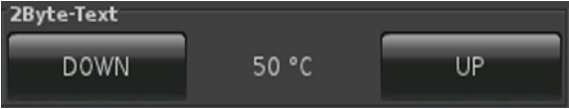
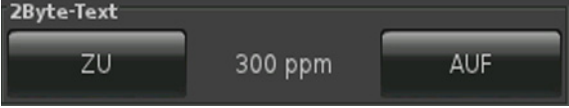
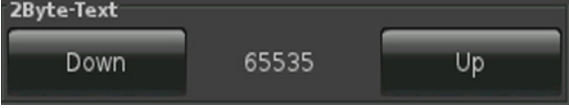
Examples	Element Name; Format
	2Byte-Text; PF=°C; B+=UP; B-=DOWN; MIN=50; MAX=200; STEPS=75; REP=500;
	2Byte-Text; PF=ppm; B+=AUF; B-=ZU; MIN=300; MAX=1100; STEPS=400; REP=500;
	2Byte-Text;

2.6.2 2-Byte-Value-Picture-Button 0 .. 65535

ETS Objects		
Range of values	0 .. 65535	
Input	Feedback	2 Byte
Output	Switching	2 Byte

Format	
W	Determines width of button's surface
IMGSET	Choosing set of images
NOBG	No button background
PF	Declaration of the unit
STEPS	Setting step quantity
MIN	Default setting of lower limit
MAX	Default setting of upper limit
REP	Setting repetition rate
RDRQ	Read Request
PIN	In case "Use PIN" is selected, an individual password can be assigned using PIN
AL	Alarm lower limit ONLY ON ALARM PAGE
AH	Alarm upper limit ONLY ON ALARM PAGE

Simple circuit element to send/receive a 2-byte value 0 .. 65535.

Use **IMGSET** to choose the set of images you want to use.

NOBG eliminates the button's surface and the display is visualized directly on the background.

Using **PF**, a unit of measurement can be adjusted according to the measured value.

STEPS determines the step quantity for adjusting the value between MIN and MAX.

MIN determines lower limit.

MAX determines upper limit.

When pressing the buttons a little longer, **REP** sets the interval by which the values are sent. (in milliseconds)

RDRQ sent a read request at start-up for the used widgets. This parameter only works when Communication Address and Receive Flag are set.

If "Use PIN" is selected, the default master password will be used in case **PIN** is not set. Using **PIN**, an individual password can be assigned.

AL/AH can only be used on alarm page. They serve as a limit setting the temporal point from which an alarm is detected.

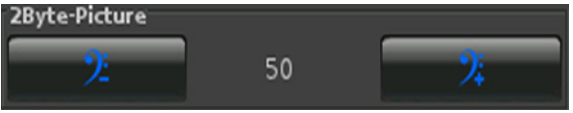
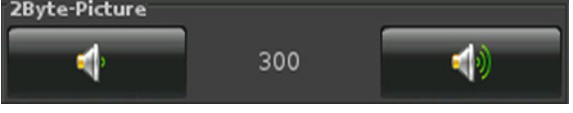
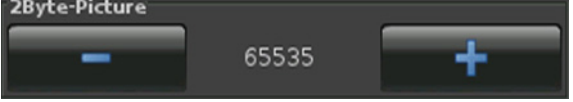
Examples	Element Name; Format
	2Byte-Picture; IMGSET=bass; MIN=50; MAX=200; STEPS=75; REP=500;
	2Byte-Picture; IMGSET=volume; MIN=300; MAX=1100; STEPS=400; REP=500;
	2Byte-Picture;

2.6.3 2-Byte-Value-Slider 0 .. 65535

ETS Objects		
Range of values	0 .. 65535	
Input	Feedback	2 Byte
Output	Switching	2 Byte

Format	
W	Determines width of button's surface
IMGSET	Choosing set of images
NOBG	No button background
PF	Declaration of the unit
STEPS	Setting step quantity
MIN	Default setting of lower limit
MAX	Default setting of upper limit
REP	Setting repetition rate
RDRQ	Read Request
PIN	In case "Use PIN" is selected, an individual password can be assigned using PIN
AL	Alarm lower limit ONLY ON ALARM PAGE
AH	Alarm upper limit ONLY ON ALARM PAGE

Simple circuit element to send/receive a 2-byte value 0 .. 65535.

Use **IMGSET** to choose the set of images you want to use.

NOBG eliminates the button's surface and the display is visualized directly on the background.

Using **PF**, a unit of measurement can be adjusted according to the measured value.

STEPS determines the step quantity for adjusting the value between MIN and MAX.

MIN determines lower limit.

MAX determines upper limit.

When pressing the buttons a little longer, **REP** sets the interval by which the values are sent. (in milliseconds)

RDRQ sent a read request at start-up for the used widgets. This parameter only works when Communication Address and Receive Flag are set.

If "Use PIN" is selected, the default master password will be used in case **PIN** is not set. Using **PIN**, an individual password can be assigned.

AL/AH can only be used on alarm page. They serve as a limit setting the temporal point from which an alarm is detected.

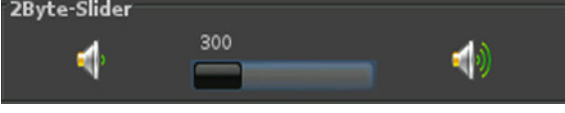
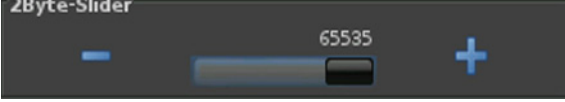
Examples	Element Name; Format
	2Byte-Slider; IMGSET=bass; MIN=50; MAX=200; STEPS=75; REP=500;
	2Byte-Slider; IMGSET=volume; MIN=300; MAX=1100; STEPS=400; REP=500;
	2Byte-Slider;

2.6.4 2-Byte-Value-Text-Button -32768 .. 32767

ETS Objects		
Range of values	-32768 .. 32767	
Input	Feedback	2 Byte
Output	Switching	2 Byte

Format	
W	Determines width of button's surface
B+	Text default for button on incrementing
B-	Text default for button on decrementing
NOBG	No button background
PF	Declaration of the unit
STEPS	Setting step quantity
MIN	Default setting of lower limit
MAX	Default setting of upper limit
REP	Setting repetition rate
RDRQ	Read Request
PIN	In case "Use PIN" is selected, an individual password can be assigned using PIN
AL	Alarm lower limit ONLY ON ALARM PAGE
AH	Alarm upper limit ONLY ON ALARM PAGE

Simple circuit element to send/receive a 2-byte value -32768 .. 32767.

Use **B-** and **B+** to determine the button's texts.

NOBG eliminates the button's surface and the display is visualized directly on the background.

Using **PF**, a unit of measurement can be adjusted according to the measured value.

STEPS determines the step quantity for adjusting the value between MIN and MAX.

MIN determines lower limit.

MAX determines upper limit.

When pressing the buttons a little longer, **REP** sets the interval by which the values are sent. (in milliseconds)

RDRQ sent a read request at start-up for the used widgets. This parameter only works when Communication Address and Receive Flag are set.

If "Use PIN" is selected, the default master password will be used in case **PIN** is not set. Using **PIN**, an individual password can be assigned.

AL/AH can only be used on alarm page. They serve as a limit setting the temporal point from which an alarm is detected.

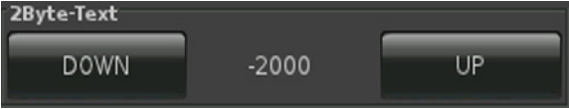
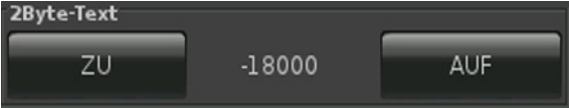
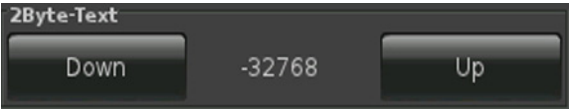
Examples	Element Name; Format
	2Byte-Text; B+=UP; B-=DOWN; MIN=-2000; MAX=100;
	2Byte-Text; B+=AUF; B-=ZU; MIN=-18000; MAX=2000;
	2Byte-Text;

2.6.5 2-Byte-Value-Picture-Button -32768 .. 32767

ETS Objects		
Range of values	-32768 .. 32767	
Input	Feedback	2 Byte
Output	Switching	2 Byte

Format	
W	Determines width of button's surface
IMGSET	Choosing set of images
NOBG	No button background
PF	Declaration of the unit
STEPS	Setting step quantity
MIN	Default setting of lower limit
MAX	Default setting of upper limit
REP	Setting repetition rate
RDRQ	Read Request
PIN	In case "Use PIN" is selected, an individual password can be assigned using PIN
AL	Alarm lower limit ONLY ON ALARM PAGE
AH	Alarm upper limit ONLY ON ALARM PAGE

Simple circuit element to send/receive a 2-byte value -32768 .. 32767.

Use **IMGSET** to choose the set of images you want to use.

NOBG eliminates the button's surface and the display is visualized directly on the background.

Using **PF**, a unit of measurement can be adjusted according to the measured value.

STEPS determines the step quantity for adjusting the value between MIN and MAX.

MIN determines lower limit.

MAX determines upper limit.

When pressing the buttons a little longer, **REP** sets the interval by which the values are sent. (in milliseconds)

RDRQ sent a read request at start-up for the used widgets. This parameter only works when Communication Address and Receive Flag are set.

If "Use PIN" is selected, the default master password will be used in case **PIN** is not set. Using **PIN**, an individual password can be assigned.

AL/AH can only be used on alarm page. They serve as a limit setting the temporal point from which an alarm is detected.

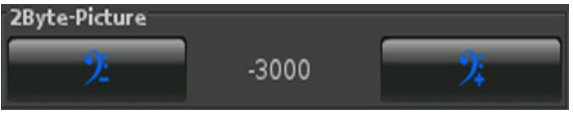
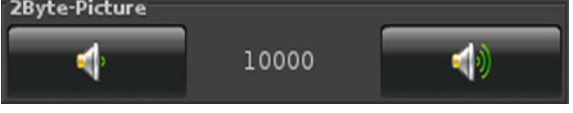
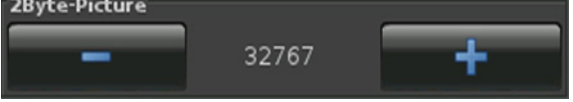
Examples	Element Name; Format
	2Byte-Picture; IMGSET=bass; MIN=-3000; MAX=-100;
	2Byte-Picture; IMGSET=volume; MIN=-20000; MAX=10000;
	2Byte-Picture;

2.6.6 2-Byte-Value-Slider -32768 .. 32767

ETS Objects		
Range of values	-32768 .. 32767	
Input	Feedback	2 Byte
Output	Switching	2 Byte

Format	
W	Determines width of button's surface
IMGSET	Choosing set of images
NOBG	No button background
PF	Declaration of the unit
STEPS	Setting step quantity
MIN	Default setting of lower limit
MAX	Default setting of upper limit
REP	Setting repetition rate
RDRQ	Read Request
PIN	In case "Use PIN" is selected, an individual password can be assigned using PIN
AL	Alarm lower limit ONLY ON ALARM PAGE
AH	Alarm upper limit ONLY ON ALARM PAGE

Simple circuit element to send/receive a 2-byte value -32768 .. 32767.

Use **IMGSET** to choose the set of images you want to use.

NOBG eliminates the button's surface and the display is visualized directly on the background.

Using **PF**, a unit of measurement can be adjusted according to the measured value.

STEPS determines the step quantity for adjusting the value between MIN and MAX.

MIN determines lower limit.

MAX determines upper limit.

When pressing the buttons a little longer, **REP** sets the interval by which the values are sent. (in milliseconds)

RDRQ sent a read request at start-up for the used widgets. This parameter only works when Communication Address and Receive Flag are set.

If "Use PIN" is selected, the default master password will be used in case **PIN** is not set. Using **PIN**, an individual password can be assigned.

AL/AH can only be used on alarm page. They serve as a limit setting the temporal point from which an alarm is detected.

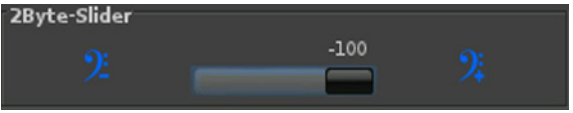
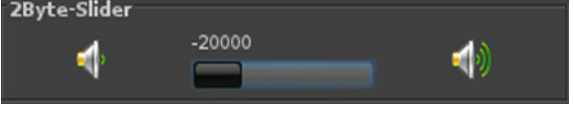
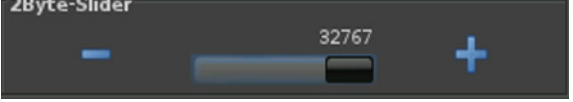
Examples	Element Name; Format
	2Byte-Slider; IMGSET=bass; MIN=-3000; MAX=-100;
	2Byte-Slider; IMGSET=volume; MIN=-20000; MAX=10000;
	2Byte-Slider;

2.6.7 2-Byte-Float-Text-Button

ETS Objects		
Range of values	2 Byte Float	
Input	Feedback	2 Byte
Output	Switching	2 Byte

Format	
W	Determines width of button's surface
B+	Text default for button on incrementing
B-	Text default for button on decrementing
NOBG	No button background
PF	Declaration of the unit
STEPS	Setting step quantity
MIN	Default setting of lower limit
MAX	Default setting of upper limit
REP	Setting repetition rate
RDRQ	Read Request
DC	Number of displayed decimal places
*	Multiplication factor
PIN	In case "Use PIN" is selected, an individual password can be assigned using PIN
AL	Alarm lower limit ONLY ON ALARM PAGE
AH	Alarm upper limit ONLY ON ALARM PAGE

Simple circuit element to send/receive a 2-byte float value.

Use **B-** and **B+** to determine the button's texts.

NOBG eliminates the button's surface and the display is visualized directly on the background.

Using **PF**, a unit of measurement can be adjusted according to the measured value.

DC defines the displayed decimal places.

Use ***** to determine a multiplication factor.

STEPS determines the step quantity for adjusting the value between MIN and MAX.

MIN determines lower limit.

MAX determines upper limit.

When pressing the buttons a little longer, **REP** sets the interval by which the values are sent. (in milliseconds)

RDRQ sent a read request at start-up for the used widgets. This parameter only works when Communication Address and Receive Flag are set.

If "Use PIN" is selected, the default master password will be used in case **PIN** is not set. Using **PIN**, an individual password can be assigned.

AL/AH can only be used on alarm page. They serve as a limit setting the temporal point from which an alarm is detected.

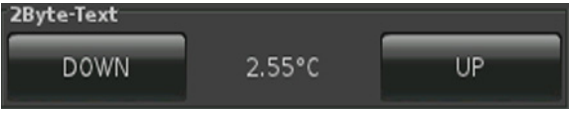
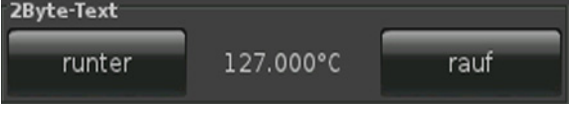
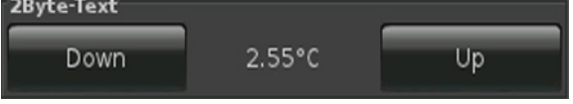
Examples	Element Name; Format
	2Byte-Text; B+=UP; B-=DOWN; PF=°C; DC=2;
	2Byte-Text; B+=rauf; B-=runter; PF=°C; DC=3; *=100;
	2Byte-Text;

2.6.8 2-Byte-Float-Picture-Button

ETS Objects		
Range of values	2 Byte Float	
Input	Feedback	2 Byte
Output	Switching	2 Byte

Format	
W	Determines width of button's surface
IMGSET	Choosing set of images
NOBG	No button background
PF	Declaration of the unit
STEPS	Setting step quantity
MIN	Default setting of lower limit
MAX	Default setting of upper limit
REP	Setting repetition rate
RDRQ	Read Request
DC	Number of displayed decimal places
*	Multiplication factor
PIN	In case "Use PIN" is selected, an individual password can be assigned using PIN
AL	Alarm lower limit ONLY ON ALARM PAGE
AH	Alarm upper limit ONLY ON ALARM PAGE

Simple circuit element to send/receive a 2-byte float value.

Use **IMGSET** to choose the set of images you want to use.

NOBG eliminates the button's surface and the display is visualized directly on the background.

Using **PF**, a unit of measurement can be adjusted according to the measured value.

DC defines the displayed decimal places.

Use ***** to determine a multiplication factor.

STEPS determines the step quantity for adjusting the value between MIN and MAX.

MIN determines lower limit.

MAX determines upper limit.

When pressing the buttons a little longer, **REP** sets the interval by which the values are sent. (in milliseconds)

RDRQ sent a read request at start-up for the used widgets. This parameter only works when Communication Address and Receive Flag are set.

If "Use PIN" is selected, the default master password will be used in case **PIN** is not set. Using **PIN**, an individual password can be assigned.

AL/AH can only be used on alarm page. They serve as a limit setting the temporal point from which an alarm is detected.

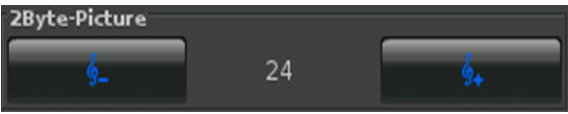
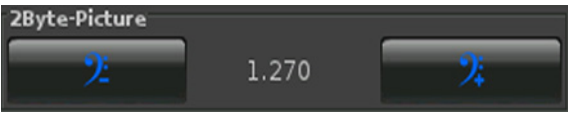
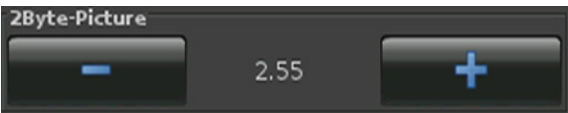
Examples	Element Name; Format
<p>2Byte-Picture</p> 	<p>2Byte-Picture; IMGSET=treble; DC=0; PF= ;</p>
<p>2Byte-Picture</p> 	<p>2Byte-Picture; IMGSET=bass; DC=3; *=0,01; PF= ;</p>
<p>2Byte-Picture</p> 	<p>2Byte-Picture; PF= ;</p>

2.6.9 2-Byte-Float-Slider

ETS Objects		
Range of values	2 Byte Float	
Input	Feedback	2 Byte
Output	Switching	2 Byte

Format	
W	Determines width of button's surface
IMGSET	Choosing set of images
NOBG	No button background
PF	Declaration of the unit
STEPS	Setting step quantity
MIN	Default setting of lower limit
MAX	Default setting of upper limit
REP	Setting repetition rate
RDRQ	Read Request
DC	Number of displayed decimal places
*	Multiplication factor
PIN	In case "Use PIN" is selected, an individual password can be assigned using PIN
AL	Alarm lower limit ONLY ON ALARM PAGE
AH	Alarm upper limit ONLY ON ALARM PAGE

Simple circuit element to send/receive a 2-byte float value.

Use **IMGSET** to choose the set of images you want to use.

NOBG eliminates the button's surface and the display is visualized directly on the background.

Using **PF**, a unit of measurement can be adjusted according to the measured value.

DC defines the displayed decimal places.

Use ***** to determine a multiplication factor.

STEPS determines the step quantity for adjusting the value between MIN and MAX.

MIN determines lower limit.

MAX determines upper limit.

When pressing the buttons a little longer, **REP** sets the interval by which the values are sent. (in milliseconds)

RDRQ sent a read request at start-up for the used widgets. This parameter only works when Communication Address and Receive Flag are set.

If "Use PIN" is selected, the default master password will be used in case **PIN** is not set. Using **PIN**, an individual password can be assigned.

AL/AH can only be used on alarm page. They serve as a limit setting the temporal point from which an alarm is detected.

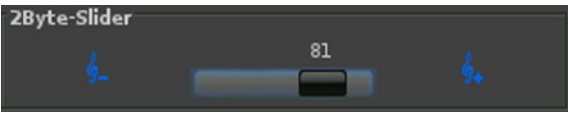
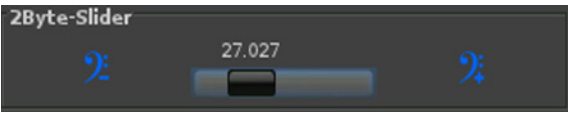
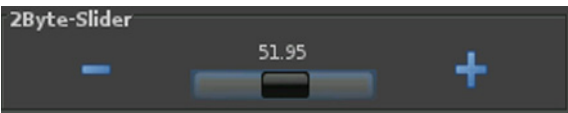
Examples	Element Name; Format
	2Byte-Slider; IMGSET=treble; DC=0; PF= ;
	2Byte-Slider; IMGSET=bass; DC=3; *=0,01; PF= ;
	2Byte-Slider; PF= ;

2.6.10 2-Byte-Value-Pushbutton

ETS Objects		
Range of values	0 .. 65535	
Input	-	-
Output	Value	2 Byte
	Value B	2 Byte

Format	
IMG	Choosing an image
PRESS	Value that will be sent when pressing button
RELEASE	Value that will be sent when releasing button
LABEL	Text default for button
NOBG	No button background
JUMP	Command to jump to a user-defined page
LOGIC	Function call or direct incorporation of a logical function
LOGICR	Function call or direct incorporation of a logical function
PIN	In case "Use PIN" is selected, an individual password can be assigned using PIN

Simple button element to send a 2-byte value 0 .. 65535.

Using **LABEL**, you can define the text, or else an image using **IMG**, on the button.

PRESS determines the value that will be sent when pressing the button.



RELEASE determines the value that will be sent when releasing the button.

NOBG eliminates the button's surface and the display is visualized directly on the background.

Using **LOGIC**, LUA functions can be activated or manually incorporated in a LUA syntax-based logical function which is triggered when pressing the button.

Using **LOGICR**, LUA functions can be activated or manually incorporated in a LUA syntax-based logical function which is triggered when releasing the button.

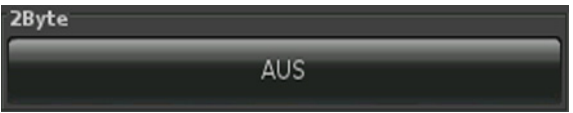
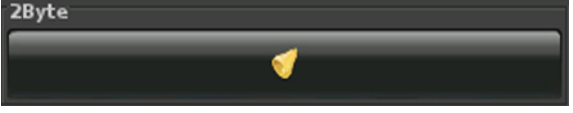
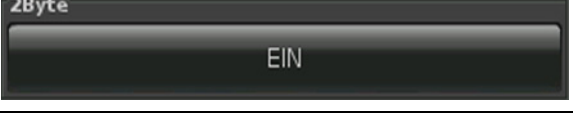
If "Use PIN" is selected, the default master password will be used in case **PIN** is not set. Using **PIN**, an individual password can be assigned.

Examples	Element Name; Format
	2Byte; PRESS=6500; LABEL=AUS;
	2Byte; PRESS=10050; IMG=bell_b_on;
	2Byte; RELEASE=1; LABEL=EIN;
	2Byte; RELEASE=0; IMG=sound_b_off;

2.6.11 2-Byte-Float-Value-Pushbutton

ETS Objects		
Range of values	2 Byte Float	
Input	-	-
Output	Value	2 Byte
	Value B	2 Byte

Format	
IMG	Choosing an image
PRESS	Value that will be sent when pressing button
RELEASE	Value that will be sent when releasing button
LABEL	Text default for button
NOBG	No button background
JUMP	Command to jump to a user-defined page
LOGIC	Function call or direct incorporation of a logical function
LOGICR	Function call or direct incorporation of a logical function
PIN	In case "Use PIN" is selected, an individual password can be assigned using PIN

Simple button element to send a 2-byte float value.

Using **LABEL**, you can define the text, or else an image using **IMG**, on the button.

PRESS determines the value that will be sent when pressing the button.

RELEASE determines the value that will be sent when releasing the button.

NOBG eliminates the button's surface and the display is visualized directly on the background.

Using **LOGIC**, LUA functions can be activated or manually incorporated in a LUA syntax-based logical function which is triggered when pressing the button.

Using **LOGICR**, LUA functions can be activated or manually incorporated in a LUA syntax-based logical function which is triggered when releasing the button.

If "Use PIN" is selected, the default master password will be used in case **PIN** is not set. Using **PIN**, an individual password can be assigned.

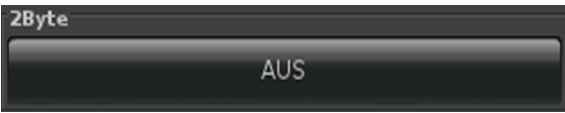
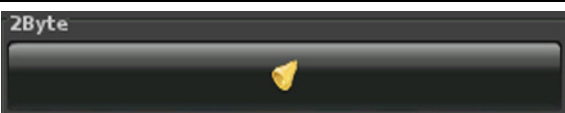
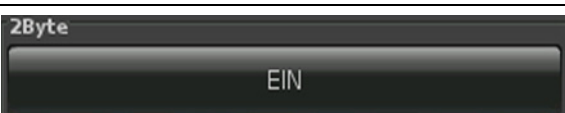
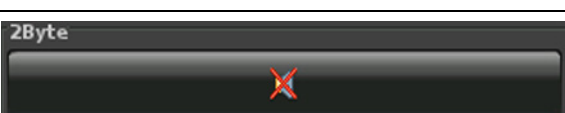
Examples	Element Name; Format
<p>2Byte</p> 	<p>2Byte; PRESS=32,5; LABEL=AUS;</p>
<p>2Byte</p> 	<p>2Byte; PRESS=-12,25; IMG=bell_b_on;</p>
<p>2Byte</p> 	<p>2Byte; RELEASE=0,01; LABEL=EIN;</p>
<p>2Byte</p> 	<p>2Byte; RELEASE=0; IMG=sound_b_off;</p>

2.6.12 2-Byte-Float-Timer-Profile

ETS Objects		
Range of values	2 Byte Float	
Input	-	-
Output	Profile	2 Byte
Input/Output	Profile Enable	1 Bit

Format	
W	Determines width of display's surface
IMG	Choosing an image
OVRTO	Determines the time (in minutes) until manual settings are overwritten
NOBG	No button background
STEP	Setting step size
MIN	Default setting of lower limit
MAX	Default setting of upper limit
RDRQ	Read Request
PIN	In case "Use PIN" is selected, an individual password can be assigned using PIN
PPIN	In case "Use PIN" is selected, an individual password for the secondary function can be assigned using PPIN

Complex element to send a 2-byte float value in a set time allowance.

W(in Pixel) determines the width of the display's surface.

OVRTO determines the span of time, after which the settings made manually by the user are overwritten by the values set in the time table. (in minutes)

NOBG eliminates the button's surface and the display is visualized directly on the background.

STEP determines the step size for adjusting the value between MIN and MAX.



MIN determines lower limit.

MAX determines upper limit.



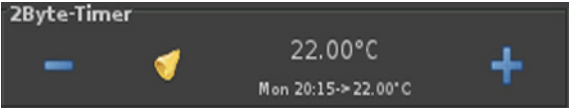
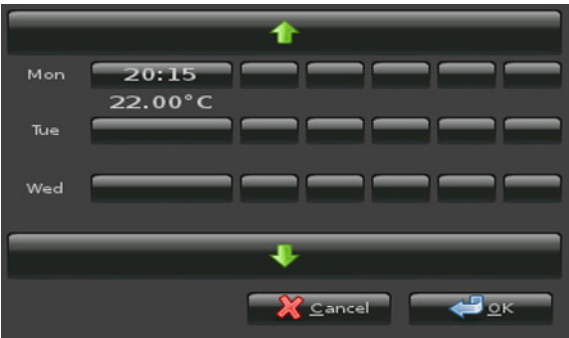

RDRQ sent a read request at start-up for the used widgets. This parameter only works when Communication Address and Receive Flag are set.

If "Use PIN" is selected, the default master password will be used in case **PIN** is not set. Using **PIN**, an individual password can be assigned.

In case "Use PIN" is selected, an individual password can be assigned using **PPIN**, which protects the secondary functions of this object.

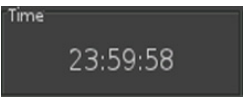
Examples	Element Name; Format
	2Byte-Timer; IMG=bell_b_on.png; NOBG; OVRTO=1;
	Pressing the options button will open a dialog box where time allowances can be set, according to which the ETS object is then controlled.
	It is possible to determine up to 6 times for each weekday, at which freely selectable values out of the object value range can be sent.

2.7 Overview 3-Byte Time / Date Elements

Image	Element Number	Element Type	Details Page
	Range of Values	Format	
	50	3-Byte-Time	 59
	Time	LONG,NOBG,ACTUAL,RDRQ,PIN	
	51	3-Byte-Date	 60
	Date	LONG,NOBG,ACTUAL,RDRQ,PIN	



2.7.1 3-Byte-Time

ETS Objects		
Range of values	Time	
Input	Feedback	3 Byte
Input/Output	Time	3 Byte

Format	
LONG	Activating weekday statement
NOBG	No button background (only possible in special modification)
ACTUAL	Visualising internal time
RDRQ	Read Request
PIN	In case "Use PIN" is selected, an individual password can be assigned using PIN

Complex clock element to send/receive a 3-byte value.
Use **LONG** to add weekday to time.
Use **ACTUAL** to visualise internal time. (Without use of communication objects)
NOBG eliminates the button's surface and the display is visualized directly on the background.
RDRQ sent a read request at start-up for the used widgets. This parameter only works when Communication Address and Receive Flag are set.
If "Use PIN" is selected, the default master password will be used in case **PIN** is not set. Using **PIN**, an individual password can be assigned.

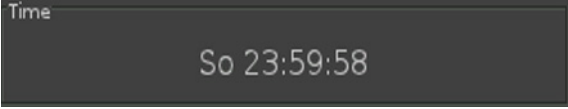
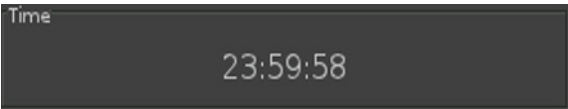
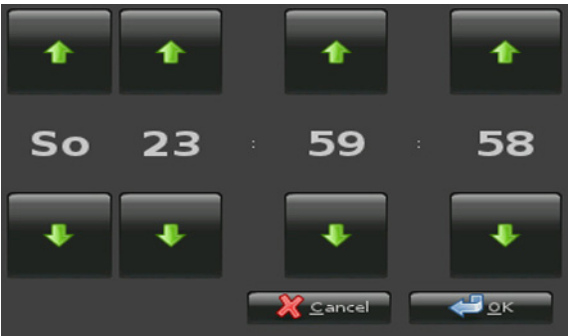
Examples	Element Name; Format
	Time; LONG;
	Time;
	Pressing the time button will open a dialog box where time allowances can be set, according to which the ETS object is then controlled.



2.7.2 3-Byte-Date

ETS Objects		
Range of values	Date	
Input	Feedback	3 Byte
Input/Output	Date	3 Byte

Format	
LONG	Activating long year display
NOBG	No button background (only possible in special modification)
ACTUAL	Visualising internal date
RDRQ	Read Request
PIN	In case "Use PIN" is selected, an individual password can be assigned using PIN

Complex date element to send/receive a 3-byte value.

Use **LONG** to change the output of the year display from 2 into 4 digits.

Use **ACTUAL** to visualise the internal date. (Without use of communication objects)

NOBG eliminates the button's surface and the display is visualized directly on the background.





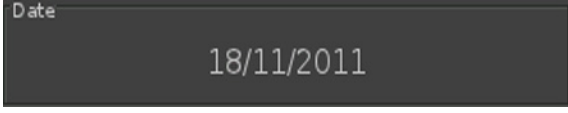
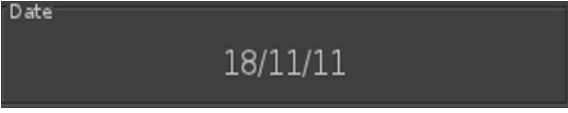
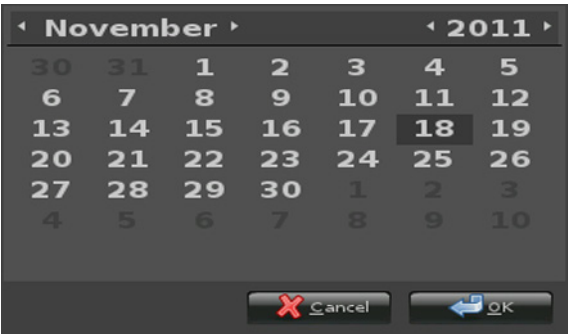



RDRQ sent a read request at start-up for the used widgets. This parameter only works when Communication Address and Receive Flag are set.

If "Use PIN" is selected, the default master password will be used in case **PIN** is not set. Using **PIN**, an individual password can be assigned.

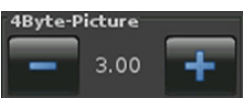
Examples	Element Name; Format
	Date; LONG;
	Date;
	Pressing the date button will open a dialog box where date allowances can be set, according to which the ETS object is then controlled.

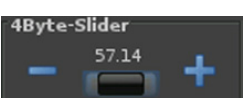

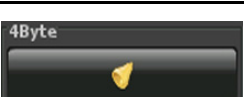
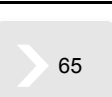
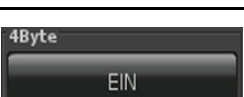
2.8 Overview 4-Byte Elements

Image	Element Number	Element Type	Details Page
	Range of Values	Format	
	33	4-Byte-Float-Text-Button	 62
	IEEE 754	W,B-,B+,PF,STEPS,MIN,MAX,AL,AH,NOBG,REP,RDRQ,DC,PIN,*,INT,UINT	
	34	4-Byte-Float-Picture-Button	 63
	IEEE 754	W,PF,IMGSET,STEPS,MIN,MAX,AL,AH,NOBG,REP,RDRQ,DC,PIN,*,INT,UINT	
	35	4-Byte-Float-Slider	 64
	IEEE 754	W,PF,IMGSET,STEPS,MIN,MAX,AL,AH,NOBG,REP,RDRQ,DC,PIN,*,INT,UINT	
	44	4-Byte-Value-Pushbutton	 65
	IEEE 754	IMG,PRESS,RELEASE,LABEL,NOBG,JUMP,LOGIC,LOGICR,PIN	
	45	4-Byte-Float-Value-Pushbutton	 66
	IEEE 754	IMG,PRESS,RELEASE,LABEL,NOBG,JUMP,LOGIC,LOGICR,PIN	

2.8.1 4-Byte-Float-Text-Button

ETS Objects		
Range of values	4 Byte	
Input	Feedback	4 Byte
Output	Switching	4 Byte

Format	
W	Determines width of button's surface
B+	Text default for button on incrementing
B-	Text default for button on decrementing
NOBG	No button background
PF	Declaration of the unit
STEPS	Setting step quantity
MIN	Default setting of lower limit
MAX	Default setting of upper limit
REP	Setting repetition rate
RDRQ	Read Request
DC	Number of displayed decimal places
*	Multiplication factor
INT	Shift of number range to integer
UINT	Shift of number range to unsigned integer
PIN	In case "Use PIN" is selected, an individual password can be assigned using PIN
AL	Alarm lower limit ONLY ON ALARM PAGE
AH	Alarm upper limit ONLY ON ALARM PAGE

Simple circuit element to send/receive a 4-byte value.

Use **B-** and **B+** to determine the button's texts.

NOBG eliminates the button's surface and the display is visualized directly on the background.

Using **PF**, a unit of measurement can be adjusted according to the measured value.

DC defines the displayed decimal places.

Use ***** to determine a multiplication factor.

STEPS determines the step quantity for adjusting the value between MIN and MAX.

MIN determines lower limit.

MAX determines upper limit.

When pressing the buttons a little longer, REP sets the interval by which the values are sent. (in milliseconds)

RDRQ sent a read request at start-up for the used widgets. This parameter only works when Communication Address and Receive Flag are set.

Using **INT** the number range can be changed from floating point (float) to integers (integer).

Using **UINT** the number range can be changed from floating point (float) to unsigned integers (unsigned Integer).

If "Use PIN" is selected, the default master password will be used in case **PIN** is not set. Using **PIN**, an individual password can be assigned.

AL/AH can only be used on alarm page. They serve as a limit setting the temporal point from which an alarm is detected.

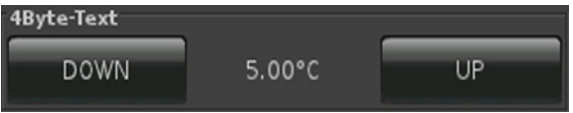
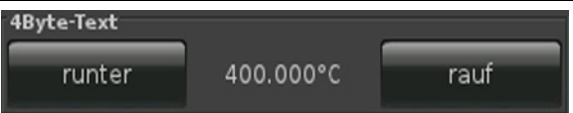
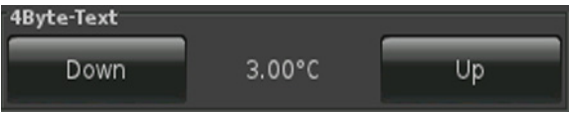
Examples	Element Name; Format
	4Byte-Text; B+=UP; B-=DOWN; PF=°C; DC=2;
	4Byte-Text; B+=rauf; B-=runter; PF=°C; DC=3; *=100;
	4Byte-Text;

2.8.2 4-Byte-Float-Picture-Button

ETS Objects		
Range of values	4 Byte	
Input	Feedback	4 Byte
Output	Switching	4 Byte

Format	
W	Determines width of button's surface
IMGSET	Choosing set of images
NOBG	No button background
PF	Declaration of the unit
STEPS	Setting step quantity
MIN	Default setting of lower limit
MAX	Default setting of upper limit
REP	Setting repetition rate
RDRQ	Read Request
DC	Number of displayed decimal places
*	Multiplication factor
INT	Shift of number range to integer
UINT	Shift of number range to unsigned integer
PIN	In case "Use PIN" is selected, an individual password can be assigned using PIN
AL	Alarm lower limit ONLY ON ALARM PAGE
AH	Alarm upper limit ONLY ON ALARM PAGE

Simple circuit element to send/receive a 4-byte value.

Use **IMGSET** to chose the set of images you want to use.

NOBG eliminates the button's surface and the display is visualized directly on the background.

Using **PF**, a unit of measurement can be adjusted according to the measured value.

DC defines the displayed decimal places.

Use * to determine a multiplication factor.

STEPS determines the step quantity for adjusting the value between MIN and MAX.

MIN determines lower limit.

MAX determines upper limit.

When pressing the buttons a little longer, **REP** sets the interval by which the values are sent. (in milliseconds)

RDRQ sent a read request at start-up for the used widgets. This parameter only works when Communication Address and Receive Flag are set.

Using **INT** the number range can be changed from floating point (float) to integers (integer).

Using **UINT** the number range can be changed from floating point (float) to unsigned integers (unsigned Integer).

If "Use PIN" is selected, the default master password will be used in case **PIN** is not set. Using **PIN**, an individual password can be assigned.

AL/AH can only be used on alarm page. They serve as a limit setting the temporal point from which an alarm is detected.

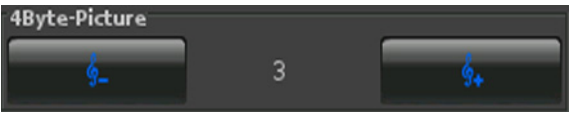
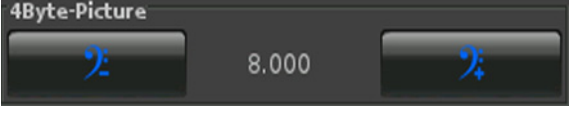
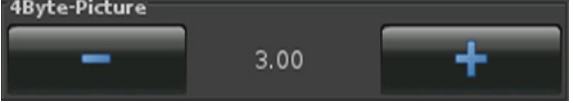
Examples	Element Name; Format
	4Byte-Picture; IMGSET=treble; DC=0; PF= ;
	4Byte-Picture; IMGSET=bass; DC=3; *=0,01; PF= ;
	4Byte-Picture; PF= ;

2.8.3 4-Byte-Float-Slider

ETS Objects		
Range of values	4 Byte	
Input	Feedback	4 Byte
Output	Switching	4 Byte

Format	
W	Determines width of button's surface
IMGSET	Choosing set of images
NOBG	No button background
PF	Declaration of the unit
STEPS	Setting step quantity
MIN	Default setting of lower limit
MAX	Default setting of upper limit
REP	Setting repetition rate
RDRQ	Read Request
DC	Number of displayed decimal places
*	Multiplication factor
INT	Shift of number range to integer
UINT	Shift of number range to unsigned integer
PIN	In case "Use PIN" is selected, an individual password can be assigned using PIN
AL	Alarm lower limit ONLY ON ALARM PAGE
AH	Alarm upper limit ONLY ON ALARM PAGE

Simple circuit element to send/receive a 4-byte value.

Use **IMGSET** to chose the set of images you want to use.

NOBG eliminates the button's surface and the display is visualized directly on the background.

Using **PF**, a unit of measurement can be adjusted according to the measured value.

DC defines the displayed decimal places.

Use ***** to determine a multiplication factor.

STEPS determines the step quantity for adjusting the value between MIN and MAX.

MIN determines lower limit.

MAX determines upper limit.

When pressing the buttons a little longer, **REP** sets the interval by which the values are sent. (in milliseconds)

RDRQ sent a read request at start-up for the used widgets. This parameter only works when Communication Address and Receive Flag are set.

Using **INT** the number range can be changed from floating point (float) to integers (integer).

Using **UINT** the number range can be changed from floating point (float) to unsigned integers (unsigned Integer).

If "Use PIN" is selected, the default master password will be used in case **PIN** is not set. Using **PIN**, an individual password can be assigned.

AL/AH can only be used on alarm page. They serve as a limit setting the temporal point from which an alarm is detected.

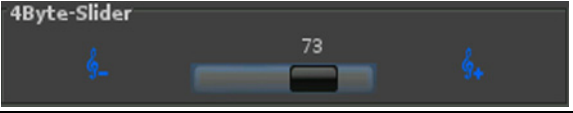
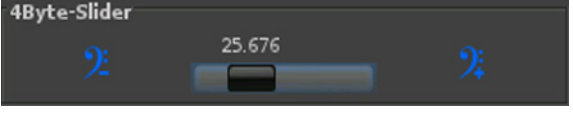
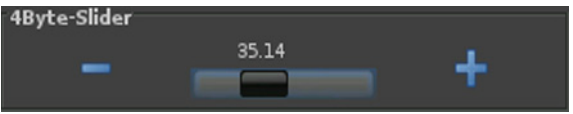
Examples	Element Name; Format
	4Byte-Slider; IMGSET=treble; DC=0; PF= ;
	4Byte-Slider; IMGSET=bass; DC=3; *=0,01; PF= ;
	4Byte-Slider; PF= ;

2.8.4 4-Byte-Value-Pushbutton

ETS Objects		
Range of values	4 Byte	
Input	-	-
Output	Value	4 Byte
	Value B	4 Byte

Format	
IMG	Choosing an image
PRESS	Value that will be sent when pressing button
RELEASE	Value that will be sent when releasing button
LABEL	Text default for button
NOBG	No button background
JUMP	Command to jump to any side
LOGIC	Function call or direct incorporation of a logical function
LOGICR	Function call or direct incorporation of a logical function
PIN	In case "Use PIN" is selected, an individual password can be assigned using PIN

Simple button element to send a 4-byte value.

Using **LABEL**, you can define the text, or else an image using **IMG**, on the button.

PRESS determines the value that will be sent when pressing the button.



RELEASE determines the value that will be sent when releasing the button.

NOBG eliminates the button's surface and the display is visualized directly on the background.

Using **LOGIC**, LUA functions can be activated or manually incorporated in a LUA syntax-based logical function which is triggered when pressing the button.

Using **LOGICR**, LUA functions can be activated or manually incorporated in a LUA syntax-based logical function which is triggered when releasing the button.

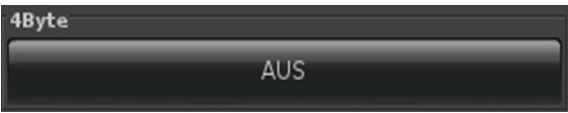
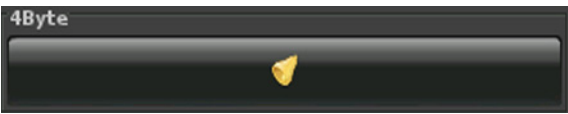
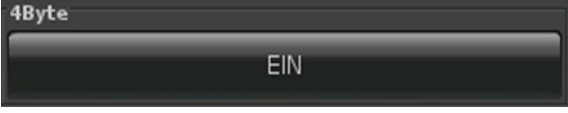
If "Use PIN" is selected, the default master password will be used in case **PIN** is not set. Using **PIN**, an individual password can be assigned.

Examples	Element Name; Format
	4Byte; PRESS=6500; LABEL=AUS;
	4Byte; PRESS=10050; IMG=bell_b_on;
	4Byte; RELEASE=1; LABEL=EIN;
	4Byte; RELEASE=0; IMG=sound_b_off;

2.8.5 4-Byte-Float-Value-Pushbutton

ETS Objects		
Range of values	4 Byte Float	
Input	-	-
Output	Value	4 Byte
	Value B	4 Byte

Format	
IMG	Choosing an image
PRESS	Value that will be sent when pressing button
RELEASE	Value that will be sent when releasing button
LABEL	Text default for button
NOBG	No button background
JUMP	Command to jump to any side
LOGIC	Function call or direct incorporation of a logical function
LOGICR	Function call or direct incorporation of a logical function
PIN	In case "Use PIN" is selected, an individual password can be assigned using PIN

Simple button element to send a 4-byte float value.

Using **LABEL**, you can define the text, or else an image using **IMG**, on the button.

PRESS determines the value that will be sent when pressing the button.



RELEASE determines the value that will be sent when releasing the button.

NOBG eliminates the button's surface and the display is visualized directly on the background.

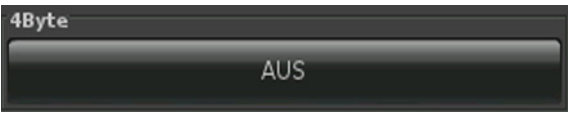
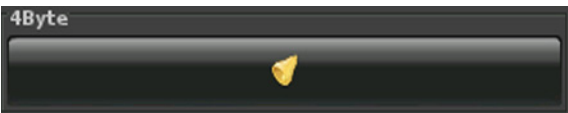
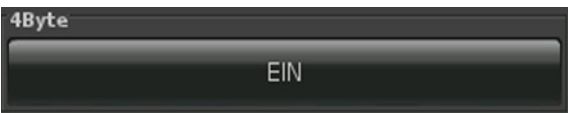

Using **LOGIC**, LUA functions can be activated or manually incorporated in a LUA syntax-based logical function which is triggered when pressing the button.

Using **LOGICR**, LUA functions can be activated or manually incorporated in a LUA syntax-based logical function which is triggered when releasing the button.

If "Use PIN" is selected, the default master password will be used in case **PIN** is not set. Using **PIN**, an individual password can be assigned.

Examples	Element Name; Format
	4Byte; PRESS=32,5; LABEL=AUS;
	4Byte; PRESS=-12,25; IMG=bell_b_on;
	4Byte; RELEASE=0,01; LABEL=EIN;
	4Byte; RELEASE=0; IMG=sound_b_off;

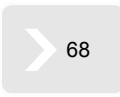
2.9 Overview 14-Byte Elements

Image	Element Number	Element Type	Details
	Range of Values	Format	Page
	46	14-Byte-String-Pushbutton	 68
	14 Byte	MG,PRESS,RELEASE,LABEL,NOBG,JUMP,LOGIC,LOGICR,PIN	
	52	14-Byte-String	 69
	14 Byte	NOBG,TEXT,RDRQ	

2.9.1 14-Byte-String-Pushbutton

ETS Objects		
Range of values	-	
Input	-	-
Output	Value	14 Byte

Format	
IMG	Choosing an image
PRESS	Value that will be sent when pressing button
RELEASE	Value that will be sent when releasing button
LABEL	Text default for button
NOBG	No button background
JUMP	Command to jump a user-defined page
LOGIC	Function call or direct incorporation of a logical function
LOGICR	Function call or direct incorporation of a logical function
PIN	In case "Use PIN" is selected, an individual password can be assigned using PIN

Simple button element to send a 14-byte string.

Using **LABEL**, you can define the text, or else an image using **IMG**, on the button.

PRESS determines the value that will be sent when pressing the button.



RELEASE determines the value that will be sent when releasing the button.

NOBG eliminates the button's surface and the display is visualized directly on the background.

Using **LOGIC**, LUA functions can be activated or manually incorporated in a LUA syntax-based logical function which is triggered when pressing the button.

Using **LOGICR**, LUA functions can be activated or manually incorporated in a LUA syntax-based logical function which is triggered when releasing the button.

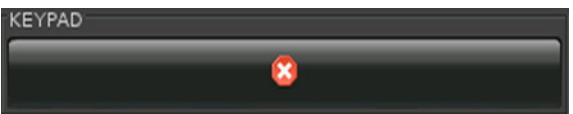
If "Use PIN" is selected, the default master password will be used in case **PIN** is not set. Using **PIN**, an individual password can be assigned.

Examples	Element Name; Format
	14Byte; PRESS=PLAY; LABEL=MUSIK;
	KEYPAD; PRESS=KEYPAD; IMG=acc_cancel_b_on; KEYPAD; RELEASE=KEYPAD; IMG=acc_cancel_b_on;
	Pressing the button will open a dialog box in which an alpha numeric input will be effected, according to which the ETS object is then controlled.



2.9.2 14-Byte-String

ETS Objects		
Range of values	-	
Input	Value	14 Byte
Output	-	-

Format	
TEXT	Text default
NOBG	No button background
RDRQ	Read Request

Examples	Element Name; Format
<div style="border: 1px solid black; background-color: #333; color: #ccc; padding: 10px; text-align: center;"> 14Byte Hallo Welt </div>	14Byte; TEXT=Hallo Welt;
<div style="border: 1px solid black; background-color: #333; color: #ccc; padding: 10px; text-align: center;"> 14Byte UG </div>	14Byte; TEXT=UG;





Simple text element to receive a 14-byte string.

Using **TEXT** a text default can be effected which will be set upon the display element as a default value after every reset.

NOBG eliminates the button's surface and the display is visualized directly on the background.

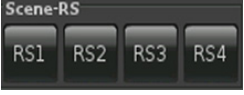
RDRQ sent a read request at start-up for the used widgets. This parameter only works when Communication Address and Receive Flag are set.

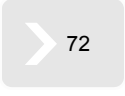
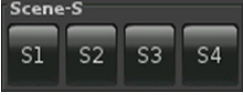
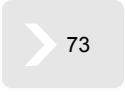
2.10 Overview Scene Elements

Image	Element Number	Element Type	Details Page
	Range of Values	Format	
	55	Scene-Control-Recall-Save	 71
	0 .. 63	TO,N,IMAGES,LABELS,SCENES,MOD, NOBG,PIN,PPIN	
	56	Scene-Control-Recall-Only	 72
	0 .. 63	TO,N,IMAGES,LABELS,SCENES,MOD, NOBG,PIN	
	57	Scene-Control-Save-Only	 73
	0 .. 63	TO,N,IMAGES,LABELS,SCENES,MOD, NOBG,PIN	
	58	Internal-Scene	 74
		SELECT,NOBG,ONSTART,SCGRP,TRIGINV, IMG,PLAYONLY,PLAYSTOP	

Until the introduction of the software version v2.18 for Touch_IT were the following element-type formats.

Element No. 55

TO,N,MOD,Nx,Sx (x = 1..4),NOBG,PIN,PPIN

Element No. 56

N,MOD,Nx,Sx (x = 1..4),NOBG,PIN

Element No. 57

N,MOD,Nx,Sx (x = 1..4),NOBG,PIN

2.10.1 Scene-Control-Recall-Save

ETS Objects		
Range of values		
Output	Scene Control 1	1 Byte
	Scene Control 2	1 Byte
	Scene Control 3	1 Byte
	Scene Control 4	1 Byte

Format		
TO	Time allowance in ms for input analysis	
N	Number of buttons displayed	
IMAGES	Imaging of the buttons	
LABELS	Labelling of buttons	
SCENES	Determination of locations in use	
MOD	Setting output parameters	
	SINGLE	Saving and activation via SC1
	DUAL	Saving control via SC2 and retrieving control via SC1
	DIFF	SC1..SC4 are working independently
NOBG	No button background	
PIN	In case "Use PIN" is selected, an individual password can be assigned using PIN	
PPIN	In case "Use PIN" is selected, an individual password for the secondary function can be assigned using PPIN	

Complex element to activate and save up to 4 external scene stores (corresponding with DPT 18.001).

Use **TO** to determine the time (in milliseconds) from which the manual input will be taken as LONG.

IMAGES, determines the imaging for each button. (only .png)

LABELS, determines the text for each button.

SCENES, define the scene memory to be used for each button.

Using **MOD**, the output control can be adjusted.

SINGLE:
Displayed buttons communicate via Scene Control 1. SC2-SC4 have no functions.



DIFF:
Displayed buttons communicate via the corresponding Scene Control objects.

DUAL:
Displayed buttons communicate via SC1 and SC2. Use SC1 to retrieve and SC2 to save scenes. SC3-SC4 have no functions.

NOBG eliminates the button's surface and the display is visualized directly on the background.

If "Use PIN" is selected, the default master password will be used in case **PIN** is not set. Using **PIN**, an individual password can be assigned.

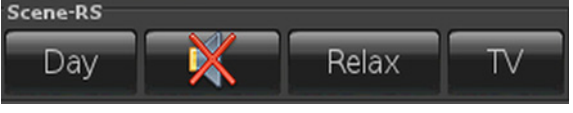
In case "Use PIN" is selected, an individual password can be assigned using **PPIN**, which protects the secondary functions of this object.

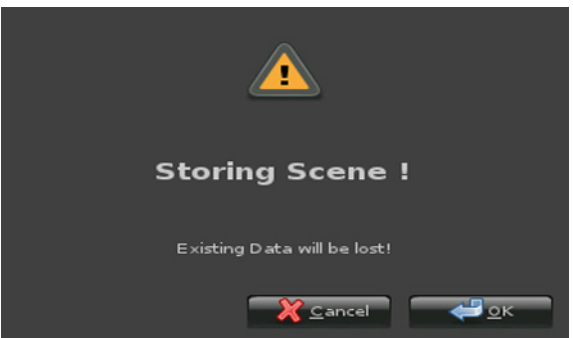
Examples	Element Name; Format
	Scene-RS; TO=1000;IMAGES=,sound_l_off; LABELS=Day,Night,Relax,TV;SCENES=4,8,16,32; +++ IMAGES overwrite LABELS +++
	Scene-RS; TO=1000;N=2;LABELS=ON,OFF;SCENES=25,50;
	After TO has elapsed, a memory dialog will open. With the confirmation and depending on the MOD position the ETS objects are set.

2.10.2 Scene-Control-Recall-Only

ETS Objects		
Range of values		
Output	Scene Control 1	1 Byte
	Scene Control 2	1 Byte
	Scene Control 3	1 Byte
	Scene Control 4	1 Byte

Format		
TO	Time allowance in ms for input analysis	
N	Number of buttons displayed	
IMAGES	Imaging of the buttons	
LABELS	Labelling of buttons	
SCENES	Determination of locations in use	
MOD	Setting output parameters	
	SINGLE	Activation via SC1
	DIFF	SC1..SC4 are working independently
NOBG	No button background	
PIN	In case "Use PIN" is selected, an individual password can be assigned using PIN	

Simple element to activate up to 4 external scene stores (corresponding with DPT 18.001).

Use **TO** to determine the time (in milliseconds) from which the manual input will be taken as LONG.

IMAGES, determines the imaging for each button. (only .png)

LABELS, determines the text for each button.

SCENES, define the scene memory to be used for each button.

Using **MOD**, the output control can be adjusted.

SINGLE:
Displayed buttons communicate via Scene Control 1. SC2-SC4 have no functions.

DIFF:
Displayed buttons communicate via the corresponding Scene Control objects.

NOBG eliminates the button's surface and the display is visualized directly on the background.

If "Use PIN" is selected, the default master password will be used in case **PIN** is not set. Using **PIN**, an individual password can be assigned.

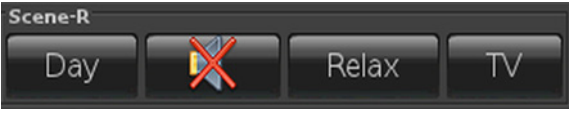
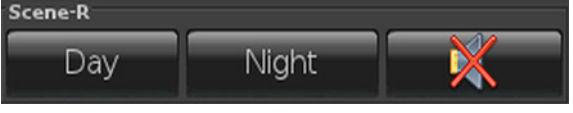
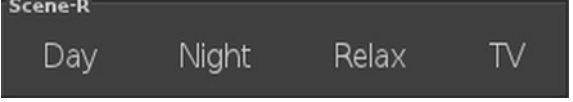
Examples	Element Name; Format
	Scene-R; TO=1000;MOD=DIFF;IMAGES=,sound_l_off; LABELS=Day,Night,Relax,TV;SCENES=4,8,16,32; +++ IMAGES overwrite LABELS +++
	Scene-R; TO=1000;N=3;IMAGES=,sound_l_off; LABELS=Day,Night,Relax;SCENES=4,8,16; +++ IMAGES overwrite LABELS +++
	Scene-R; N=4;LABELS=Day,Night,Relax,TV;SCENES=1,2,3,4;NOBG;

2.10.3 Scene-Control-Save-Only

ETS Objects		
Range of values		
Output	Scene Control 1	1 Byte
	Scene Control 2	1 Byte
	Scene Control 3	1 Byte
	Scene Control 4	1 Byte
Format		
TO	Time allowance in ms for input analysis	
N	Number of buttons displayed	
IMAGES	Imaging of the buttons	
LABELS	Labelling of buttons	
SCENES	Determination of locations in use	
MOD	Setting output parameters	
	SINGLE	Saving via SC1
	DIFF	SC1..SC4 are working independently
NOBG	No button background	
PIN	In case "Use PIN" is selected, an individual password can be assigned using PIN	

Simple element to save up to 4 external scene stores (corresponding with DPT 18.001).

Use **TO** to determine the time (in milliseconds) from which the manual input will be taken as LONG.

IMAGES, determines the imaging for each button. (only .png)

LABELS, determines the text for each button.

SCENES, define the scene memory to be used for each button.

Using **MOD**, the output control can be adjusted.

SINGLE:
Displayed buttons communicate via Scene Control 1. SC2-SC4 have no functions.

DIFF:
Displayed buttons communicate via the corresponding Scene Control objects.

NOBG eliminates the button's surface and the display is visualized directly on the background.

If "Use PIN" is selected, the default master password will be used in case **PIN** is not set. Using **PIN**, an individual password can be assigned.

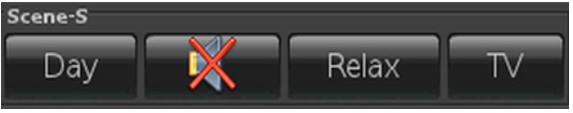
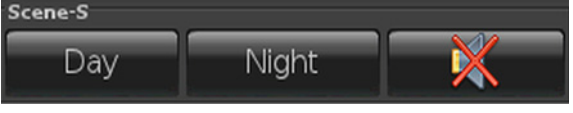
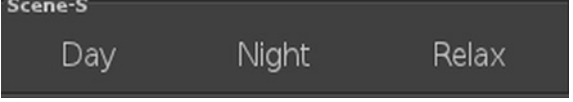
Examples	Element Name; Format
	Scene-S; TO=1000;MOD=DIFF;IMAGES=,sound_l_off; LABELS=Day,Night,Relax,TV;SCENES=4,8,16,32; +++ IMAGES overwrite LABELS +++
	Scene-S; N=3;IMAGES=,sound_l_off;LABELS=Day,Night,Relax; SCENES=4,8,16; +++ IMAGES overwrite LABELS +++
	Scene-S; N=3;LABELS=Day,Night,Relax;SCENES=4,8,16;NOBG;

2.10.4 Internal-Scene

ETS Objects		
Range of values		
Input/Output	Internal Scenes Enable	1 Bit
Input	Internal Scenes Trigger	1 Bit

Format	
SELECT	
NOBG	No button background
ONSTART	response to Power On
SCGRP	group of scenes
TRGINV	Inverts the trigger function
IMG	picture to the left edge
PLAYONLY	play only operate
PLAYSTOP	without Pause button

Internal scenes can consist of up to 32 actions, each with a delay to the previous. Each action is either a value-write to an object or a loop statement to start the sequence again.

SELECT limits the internal used object by their object number.

NOBG eliminates the button's surface and the display is visualized directly on the background.



With **ONSTART**, an automatic start at Power or when the power returns are initiated.

SCGRP=a : a = 1 .. 16 defines a group of scenes. If one of the scenes in this group is enabled all other scenes are stopped.

IMG : image to set in front of the start-button. The file types PNG, JPG and BMP are allowed. The file type is specified with. Example: sound_l_on.png

PLAYONLY, only the play button is displayed. Stopped only by the bus with trigger or enable.

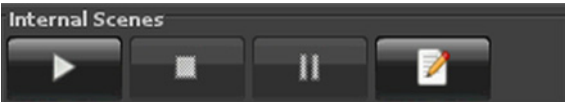
PLAYSTOP, the play and stop button will be displayed. The pause button is hidden.

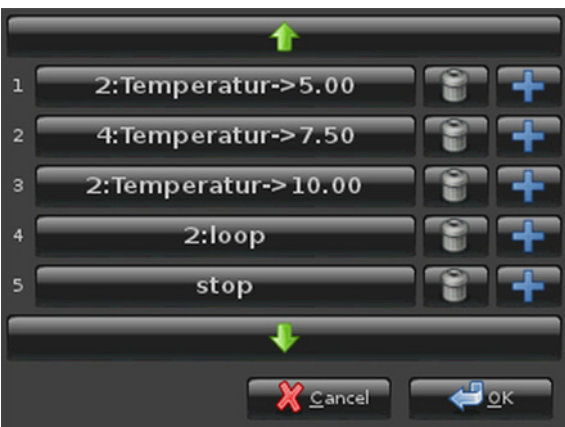
Examples	Element Name; Format
	Internal Scenes;
	Internal Scenes; PLAYSTOP;
	Internal Scenes; PLAYONLY;
	After pressing of setting, the dialog for the list of actions is open (max. 32). With "+" a free action above the selected action will be inserted.

Examples	Element Name; Format
	<p>After pressing Action 2 it opens the dialog for the parameterizing.</p> <p>For convenience you can set an internal name for each used object in its parameterizing. Example: <code>;INAME=Temperatur;B-=Down;B+=Up;PF= °C;DC=2;</code></p>



2.11 Overview RGB Elements

Image	Element Number	Element Type	Details Page
	Range of Values	Format	
	76	RGB-Dimmer-A	77
	4x (0 .. 255)	W,STEPS,IMGSET,B-,B+,NOBG,RGBH,RGBW,RDRQ,PIN	
	77	RGB-Dimmer-B	78
	4x (0 .. 255)	W,STEPS,IMGSET,B-,B+,NOBG,RGBH,RGBW,RDRQ,PIN	
	78	RGB-Dimmer-C	79
	4x (0 .. 255)	W,STEPS,IMGSET,B-,B+,NOBG,RGBH,RGBW,RDRQ,PIN	
	79	RGB-Dimmer-D	80
	4x (0 .. 255)	W,STEPS,IMGSET,B-,B+,NOBG,RGBH,RGBW,RDRQ,PIN	

2.11.1 RGB-Dimmer-A

ETS Objects		
Range of values	-	
Input	-	
Input/Output	Red	1 Byte
	Green	1 Byte
	Blue	1 Byte
	White	1 Byte

Format	
W	Determines width of display's surface
STEPS	Setting step width
IMGSET	Choosing set of images
B-	Text default for button on incrementing
B+	Text default for button on decrementing
NOBG	No button background
RGBH	RGB + brightness
RGBW	RGB + white
RDRQ	Read Request
PIN	In case "Use PIN" is selected, an individual password can be assigned using PIN

RGB element to send/receive a 3x (or 4x) 1-byte value.

Button feature:
short activation = switching ON/OFF
long activation = Dimming +/-

Set the displayed texts on the buttons using **B-** and **B+**.

Use **IMGSET** to choose the set of images you want to use.

NOBG eliminates the button's surface and the display is visualized directly on the background.

STEPS determines the step width which is required to get from the minimum to the maximum (0 .. 100%).

Using parameter **RGBH** channel 4 (White) transmits the brightness value and channels 1-3 determine the colour. (only for RGB illuminants that support this feature)

Parameter setting **RGBW** provides a 4 channel (White). Using this channel an additional white LED can be gated.

RDRQ sent a read request at start-up for the used widgets. This parameter only works when Communication Address and Receive Flag are set.

If "Use PIN" is selected, the default master password will be used in case **PIN** is not set. Using **PIN**, an individual password can be assigned.

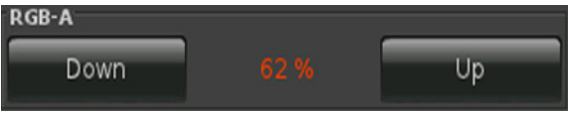
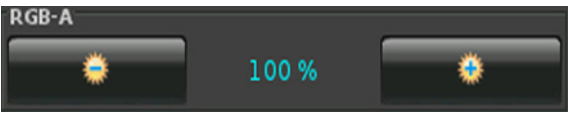
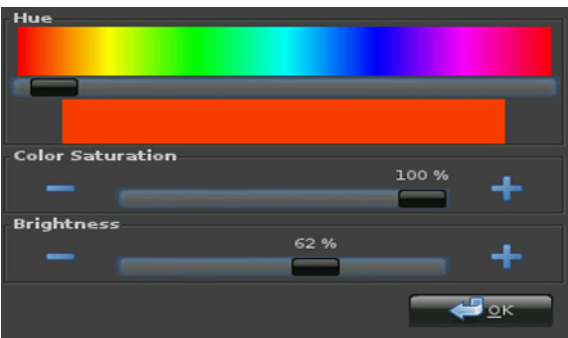
Examples	Element Name; Format
	RGB-A; B-=Down; B+=Up; STEPS=10; RGBH;
	RGB-A; IMGSET=light; RGBW;
	Pressing the per cent button will open a dialog box where colour defaults can be set, according to which the ETS objects adjust themselves.

2.11.2 RGB-Dimmer-B

ETS Objects		
Range of values	-	
Input	-	-
Input/Output	Red	1 Byte
	Green	1 Byte
	Blue	1 Byte
	White	1 Byte

Format	
W	Determines width of display's surface
STEPS	Setting step width
IMGSET	Choosing set of images
B-	Text default for button on incrementing
B+	Text default for button on decrementing
NOBG	No button background
RGBH	RGB + brightness
RGBW	RGB + white
RDRQ	Read Request
PIN	In case "Use PIN" is selected, an individual password can be assigned using PIN

RGB element to send/receive a 3x (or 4x) 1-byte value.

Button feature:
short activation = switching ON/OFF
long activation = Dimming +/-

Set the displayed texts on the buttons using **B-** and **B+**.

Use **IMGSET** to choose the set of images you want to use.

NOBG eliminates the button's surface and the display is visualized directly on the background.

STEPS determines the step width which is required to get from the minimum to the maximum (0 .. 100%).

Using parameter **RGBH** channel 4 (White) transmits the brightness value and channels 1-3 determine the colour. (only for RGB illuminants that support this feature)

Parameter setting **RGBW** provides a 4 channel (White). Using this channel an additional white LED can be gated.

RDRQ sent a read request at start-up for the used widgets. This parameter only works when Communication Address and Receive Flag are set.

If "Use PIN" is selected, the default master password will be used in case **PIN** is not set. Using **PIN**, an individual password can be assigned.

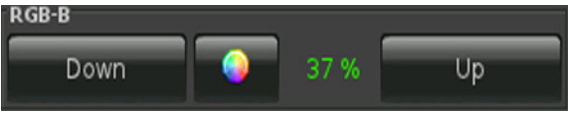
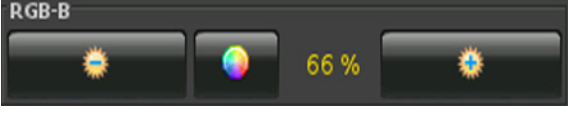
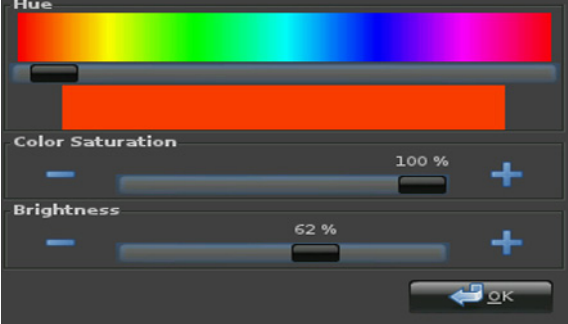
Examples	Element Name; Format
	RGB-B; B-=Down; B+=Up; STEPS=10; RGBH;
	RGB-B; IMGSET=light; RGBW;
	Pressing the per cent button will open a dialog box where colour defaults can be set, according to which the ETS objects adjust themselves.

2.11.3 RGB-Dimmer-C

ETS Objects		
Range of values	-	
Input	-	-
Input/Output	Red	1 Byte
	Green	1 Byte
	Blue	1 Byte
	White	1 Byte

Format	
W	Determines width of display's surface
STEPS	Setting step width
IMGSET	Choosing set of images
B-	Text default for button on incrementing
B+	Text default for button on decrementing
NOBG	No button background
RGBH	RGB + brightness
RGBW	RGB + white
RDRQ	Read Request
PIN	In case "Use PIN" is selected, an individual password can be assigned using PIN

RGB element to send/receive a 3x (or 4x) 1-byte value.

Button feature:
short activation = in-/decrement +/-
long activation = dimming +/-

Set the displayed texts on the buttons using **B-** and **B+**.

Use **IMGSET** to choose the set of images you want to use.

NOBG eliminates the button's surface and the display is visualized directly on the background.

STEPS determines the step width which is required to get from the minimum to the maximum (0 .. 100%).

Using parameter **RGBH**, channel 4 (White) transmits the brightness value, and channels 1-3 determine the colour. (only for RGB illuminants that support this feature)

Parameter setting **RGBW** provides a 4th channel (White). Using this channel, an additional white LED can be gated.

RDRQ sent a read request at start-up for the used widgets. This parameter only works when Communication Address and Receive Flag are set.

If "Use PIN" is selected, the default master password will be used in case **PIN** is not set. Using **PIN**, an individual password can be assigned.

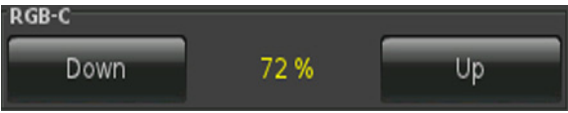
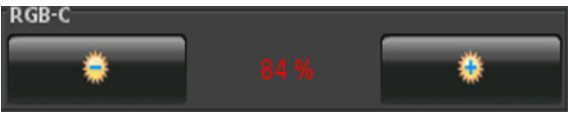
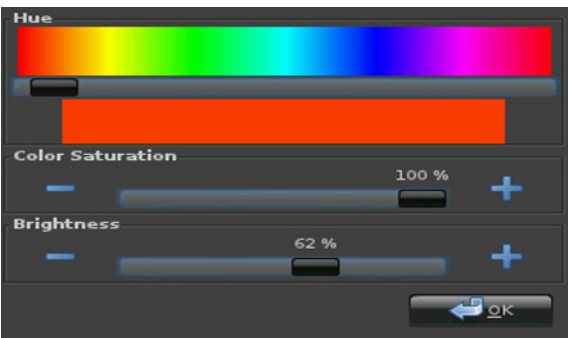
Examples	Element Name; Format
	RGB-C; B-=Down; B+=Up; STEPS=10; RGBH;
	RGB-C; IMGSET=light; RGBW;
	Pressing the per cent button will open a dialog box where colour defaults can be set, according to which the ETS objects adjust themselves.

2.11.4 RGB-Dimmer-D

ETS Objects		
Range of values	-	
Input	-	-
Input/Output	Red	1 Byte
	Green	1 Byte
	Blue	1 Byte
	White	1 Byte

Format	
W	Determines width of display's surface
STEPS	Setting step width
IMGSET	Choosing set of images
B-	Text default for button on incrementing
B+	Text default for button on decrementing
NOBG	No button background
RGBH	RGB + brightness
RGBW	RGB + white
RDRQ	Read Request
PIN	In case "Use PIN" is selected, an individual password can be assigned using PIN

RGB element to send/receive a 3x (or 4x) 1-byte value.

Button feature:
short activation = in-/decrement +/-
long activation = dimming +/-

Set the displayed texts on the buttons using **B-** and **B+**.

Use **IMGSET** to choose the set of images you want to use.

NOBG eliminates the button's surface and the display is visualized directly on the background.

STEPS determines the step width which is required to get from the minimum to the maximum (0 .. 100%).

Using parameter **RGBH**, channel 4 (White) transmits the brightness value and channels 1-3 determine the colour. (only for RGB illuminants that support this feature)

Parameter setting **RGBW** provides a 4th channel (White). Using this channel, an additional white LED can be gated.





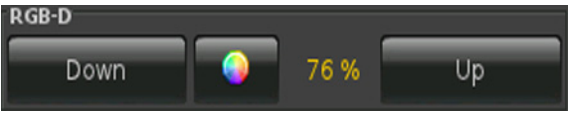
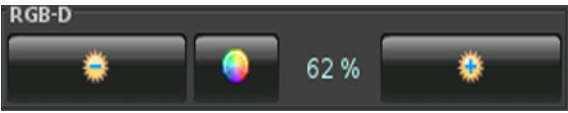
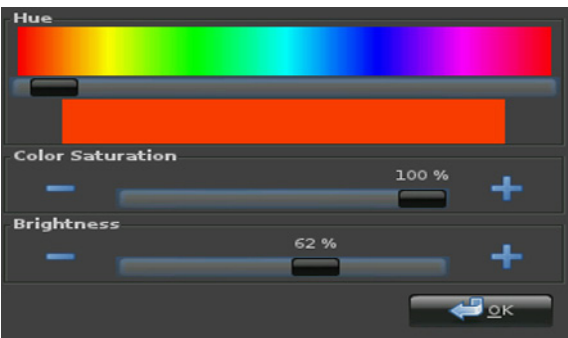

RDRQ sent a read request at start-up for the used widgets. This parameter only works when Communication Address and Receive Flag are set.

If "Use PIN" is selected, the default master password will be used in case **PIN** is not set. Using **PIN**, an individual password can be assigned.

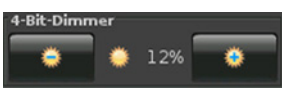
Examples	Element Name; Format
	RGB-D; B-=Down; B+=Up; STEPS=10; RGBH;
	RGB-D; IMGSET=light; RGBW;
	Pressing the per cent button will open a dialog box where colour defaults can be set, according to which the ETS objects adjust.

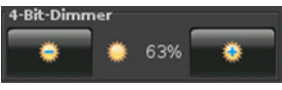

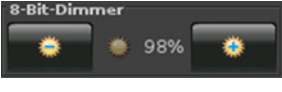
2.12 Overview Dimmer Elements

Image	Element Number	Element Type	Details Page
	Range of Values	Format	
	70	4-Bit-Dimmer-Start-Stop	 82
	0 .. 15	W,B-,B+,STEP,REP,TO,IMGSET,NOBG, RDRQ,PIN	
	71	4-Bit-Dimmer-Repeat	 83
	0 .. 15	W,B-,B+,STEP,REP,TO,IMGSET,NOBG, RDRQ,PIN	
	72	8-Bit-Dimmer-Repeat	 84
	0 .. 255	W,B-,B+,STEP,REP,TO,IMGSET,NOBG, RDRQ,PIN	

2.12.1 4-Bit-Dimmer-Start-Stop

ETS Objects		
Range of values	-	
Input	ON/OFF feedback	1 Bit
	Value Feedback	1 Byte
Output	ON/OFF	1 Bit
	Dimming	4 Bit

Format	
W	Determines width of display's surface
TO	Time allowance in ms for input analysis
REP	Setting repetition rate
STEP	Dimming step
IMGSET	Choosing set of images
B-	Text default for button on incrementing
B+	Text default for button on decrementing
NOBG	No button background
RDRQ	Read Request
PIN	In case "Use PIN" is selected, an individual password can be assigned using PIN

Simple 4-bit dimmer element to send/receive values.

Button feature:
 short activation = switching ON/OFF
 long activation = dimming
 (Afterpassing of **TO** time a dimming command will be sent when releasing a stop command.)

Using **TO**, it is possible to determine from what point onwards (in milliseconds) the manual input is interpreted as holding the button down.

Set the displayed texts on the buttons using **B-** and **B+**.

Use **IMGSET** to choose the set of images you want to use.

NOBG eliminates the button's surface and the display is visualized directly on the background.

STEP is the number of steps between 0 and 100%. (see table below)

When pressing the buttons a little longer, **REP** sets the interval by which the values are sent. (in milliseconds)

RDRQ sent a read request at start-up for the used widgets. This parameter only works when Communication Address and Receive Flag are set.

If "Use PIN" is selected, the default master password will be used in case **PIN** is not set. Using **PIN**, an individual password can be assigned.

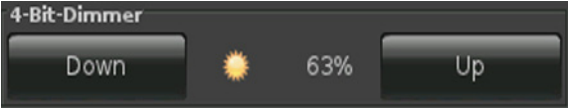
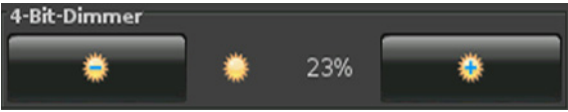
Examples	Element Name; Format
	4-Bit-Dimmer; B-=Down; B+=Up; STEP=10; REP=1000;
	4-Bit-Dimmer;

dimming step	in %
1	100%
2	50%
4	25%
8	12%
16	6%
32	3%
64	1%

2.12.1 4-Bit-Dimmer-Repeat

ETS Objects		
Range of values	-	
Input	ON/OFF feedback	1 Bit
	Value Feedback	1 Byte
Output	ON/OFF	1 Bit
	Dimming	4 Bit

Format	
W	Determines width of display's surface
TO	Time allowance in ms for input analysis
REP	Setting repetition rate
STEP	Dimming step
IMGSET	Choosing set of images
B-	Text default for button on incrementing
B+	Text default for button on decrementing
NOBG	No button background
RDRQ	Read Request
PIN	In case "Use PIN" is selected, an individual password can be assigned using PIN

Simple 4-bit dimmer element to send/receive values.

Button feature:
 short activation = switching ON/OFF
 long activation = dimming
 (After passing of **TO** time a dimming command will be repeated, when releasing a stop command.)

Using **TO**, it is possible to determine from what point onwards (in milliseconds) the manual input is interpreted as holding the button down.

Set the displayed texts on the buttons using **B-** and **B+**.

Use **IMGSET** to choose the set of images you want to use.

NOBG eliminates the button's surface and the display is visualized directly on the background.

STEP is the number of steps between 0 and 100%. (see table below)

When pressing the buttons a little longer, **REP** sets the interval by which the values are sent. (in milliseconds)

RDRQ sent a read request at start-up for the used widgets. This parameter only works when Communication Address and Receive Flag are set.

If "Use PIN" is selected, the default master password will be used in case **PIN** is not set. Using **PIN**, an individual password can be assigned.

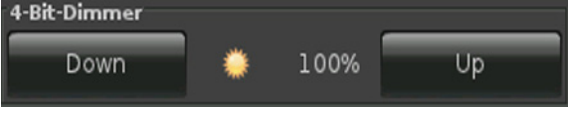
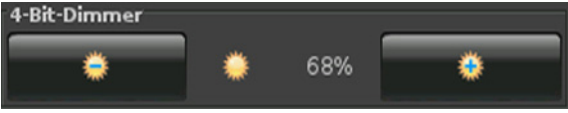
Examples	Element Name; Format
	4-Bit-Dimmer; B-=Down; B+=Up; STEP=1; REP=1000;
	4-Bit-Dimmer;

dimming step	in %
1	100%
2	50%
4	25%
8	12%
16	6%
32	3%
64	1%



2.12.1 8-Bit-Dimmer-Repeat

ETS Objects		
Range of values	-	
Input	ON/OFF feedback	1 Bit
	Value Feedback	1 Byte
Output	ON/OFF	1 Bit
	Dimming	1 Byte

Format	
W	Determines width of display's surface
TO	Time allowance in ms for input analysis
REP	Setting repetition rate
STEP	Dimming step
IMGSET	Choosing set of images
B-	Text default for button on incrementing
B+	Text default for button on decrementing
NOBG	No button background
RDRQ	Read Request
PIN	In case "Use PIN" is selected, an individual password can be assigned using PIN

Simple 8-bit dimmer element to send/receive values.

Button feature:
 short activation = switching ON/OFF
 long activation = dimming
 (After passing of **TO** time a dimming command will be repeated, when releasing a stop command.)

Using **TO**, it is possible to determine from what point onwards (in milliseconds) the manual input is interpreted as holding the button down.

Set the displayed texts on the buttons using **B-** and **B+**.

Use **IMGSET** to choose the set of images you want to use.

NOBG eliminates the button's surface and the display is visualized directly on the background.

STEP is the number of steps between 0 and 100%. (see table below)

When pressing the buttons a little longer, **REP** sets the interval by which the values are sent. (in milliseconds)

RDRQ sent a read request at start-up for the used widgets. This parameter only works when Communication Address and Receive Flag are set.

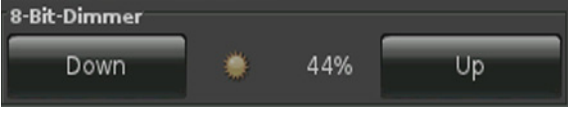
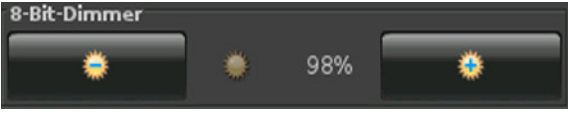

If "Use PIN" is selected, the default master password will be used in case **PIN** is not set. Using **PIN**, an individual password can be assigned.

Examples	Element Name; Format
	8-Bit-Dimmer; B-=Down; B+=Up; STEP=8; REP=1000;
	8-Bit-Dimmer;

dimming step	in %
1	100%
2	50%
4	25%
8	12%
16	6%
32	3%
64	1%

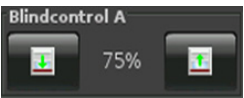
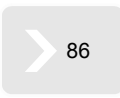
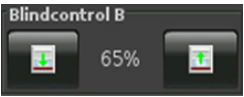
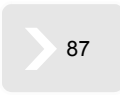
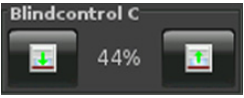

2.13 Overview Shutter-Blinds Elements

Image	Element Number	Element Type	Details
	Range of Values	Format	Page
	73	Shutter-Blinds-Control-A	 86
	0/1	W,B-,B+,REP,TO,IMGSET,NOBG,RDRQ,PIN	
	74	Shutter-Blinds-Control-B	 87
	0/1	W,B-,B+,REP,TO,IMGSET,NOBG,RDRQ,PIN	
	75	Shutter-Blinds-Control-C	 88
	0/1	W,B-,B+,REP,TO,IMGSET,NOBG,RDRQ,PIN	

2.13.1 Shutter-Blinds-Control-A

ETS Objects		
Range of values	-	
Input	Position Feedback	1 Byte
Output	LONG	1 Bit
	SHORT	1 Bit

Format	
W	Determines width of display's surface
TO	Time allowance in ms for input analysis
REP	Setting repetition rate
IMGSET	Choosing set of images
B-	Text default for button on incrementing
B+	Text default for button on decrementing
NOBG	No button background
RDRQ	Read Request
PIN	In case "Use PIN" is selected, an individual password can be assigned using PIN

Simple 4-bit dimmer element to send/receive values.

Button feature:
When pressed, a SHORT telegram will be sent (slat position / stop).
In case TO has passed, a LONG telegram (MOVE) will be sent and the shutter moves towards its end position, as long as the movement is not stopped by a new STOP command.

Using **TO**, it is possible to determine from what point onwards (in milliseconds) the manual input is interpreted as holding the button down.

Set the displayed texts on the buttons using **B-** and **B+**.

Use **IMGSET** to choose the set of images you want to use.

NOBG eliminates the button's surface and the display is visualized directly on the background.

When holding the buttons down, **REP** sets the interval by which the values are sent. (in milliseconds)

RDRQ sent a read request at start-up for the used widgets. This parameter only works when Communication Address and Receive Flag are set.

If "Use PIN" is selected, the default master password will be used in case **PIN** is not set. Using **PIN**, an individual password can be assigned.

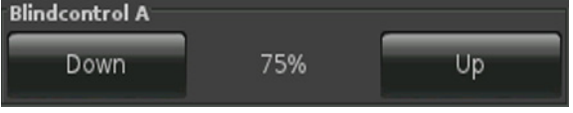
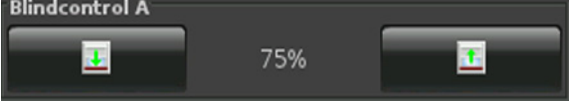
Examples	Element Name; Format
	Blindcontrol A; B-=Down; B+=Up; STEP=10; REP=1000;
	Blindcontrol A;



2.13.2 Shutter-Blinds-Control-B

ETS Objects		
Range of values	-	
Input	Position Feedback	1 Byte
Output	LONG	1 Bit
	SHORT	1 Bit

Format	
W	Determines width of display's surface
TO	Time allowance in ms for input analysis
REP	Setting repetition rate
IMGSET	Choosing set of images
B-	Text default for button on incrementing
B+	Text default for button on decrementing
NOBG	No button background
RDRQ	Read Request
PIN	In case "Use PIN" is selected, an individual password can be assigned using PIN

Simple 4-bit dimmer element to send/receive values.

Button feature:
When pressed, a SHORT telegram will be sent (slat position / stop).
In case TO has passed, a LONG telegram (MOVE) will be sent and the shutter moves towards its end position, as long as the movement is not stopped by a new STOP command.

Using **TO**, it is possible to determine from what point onwards (in milliseconds) the manual input is interpreted as holding the button down.

Set the displayed texts on the buttons using **B-** and **B+**.

Use **IMGSET** to choose the set of images you want to use.

NOBG eliminates the button's surface and the display is visualized directly on the background.

STEP determines the step size for adjusting the value between 0 and 100%.

When holding the buttons down, **REP** sets the interval by which the values are sent. (in milliseconds)

RDRQ sent a read request at start-up for the used widgets. This parameter only works when Communication Address and Receive Flag are set.

If "Use PIN" is selected, the default master password will be used in case **PIN** is not set. Using **PIN**, an individual password can be assigned.

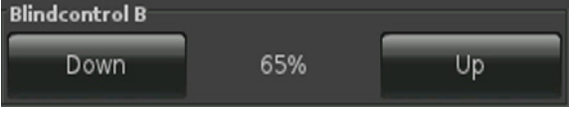
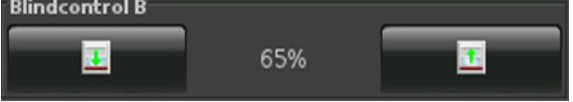
Examples	Element Name; Format
	Blindcontrol B; B-=Down; B+=Up; STEP=10; REP=1000;
	Blindcontrol B;



2.13.3 Shutter-Blinds-Control-C

ETS Objects		
Range of values	-	
Input	Position Feedback	1 Byte
Output	LONG	1 Bit
	SHORT	1 Bit

Format	
W	Determines width of display's surface
TO	Time allowance in ms for input analysis
REP	Setting repetition rate
IMGSET	Choosing set of images
B-	Text default for button on incrementing
B+	Text default for button on decrementing
NOBG	No button background
RDRQ	Read Request
PIN	In case "Use PIN" is selected, an individual password can be assigned using PIN

Simple 8-bit dimmer element to send/receive values.

Button feature:
 When pressing the button, a LONG telegram will be sent (MOVE). In case button is released during TO, a SHORT telegram (STOP) will be sent. (For alteration of slat position)
 in case TO has passed, the shutter moves towards its end position and no SHORT telegram (STOP) will be sent.

Using **TO**, it is possible to determine from what point onwards (in milliseconds) the manual input is interpreted as holding the button down.

Set the displayed texts on the buttons using **B-** and **B+**.

Use **IMGSET** to choose the set of images you want to use.

NOBG eliminates the button's surface and the display is visualized directly on the background.

STEP determines the step size for adjusting the value between 0 and 100%.

When holding the buttons down, **REP** sets the interval by which the values are sent. (in milliseconds)





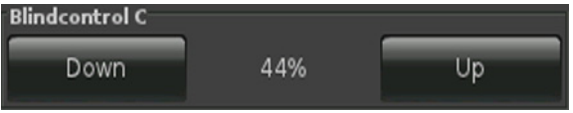
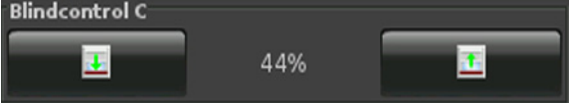



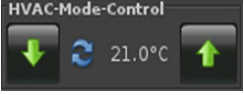

RDRQ sent a read request at start-up for the used widgets. This parameter only works when Communication Address and Receive Flag are set.

If "Use PIN" is selected, the default master password will be used in case **PIN** is not set. Using **PIN**, an individual password can be assigned.

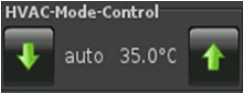
Examples	Element Name; Format
	Blindcontrol C; B-=Down; B+=Up; STEP=10; REP=1000;
	Blindcontrol C;



2.14 Overview HVAC Elements

Image	Element Number	Element Type	Details Page
	Range of Values	Format	
	80	HVAC Setpoint-Control	 90
	-671088.64 .. 670760,96	W,TO,DC,STEP,T,MIN,MAX,NOBG,MASK,INTERN,RDRQ,PIN	
	81	HVAC Mode-Control	 91
	0 .. 4	W,NOBG,MASK,INTERN,FAN,TSET RDRQ,PIN	
	82	HVAC Mode-Control-Text	 92
	0 .. 4	W,NOBG,MASK,INTERN,TSET, RDRQ,PIN	
	83	HVAC-Fan-Control	 93
	0 .. 4	W,NOBG,INTERN,RDRQ	
	65	1-Byte-Timer-Profile HVAC	 94
	0 .. 255	W,OVRTO,NOBG,IMG,RDRQ,PIN,PPIN	

2.14.1 HVAC Setpoint-Control

ETS Objects		
Range of values	-	
Input	-	
Output	Protection Setpoint	2 Byte
	Night Setpoint	2 Byte
	Standby Setpoint	2 Byte
	Comfort Setpoint	2 Byte

Format	
W	Determines width of display's surface
TO	Setting, after how much time, expressed in seconds the display returns to its standard position
DC	Number of displayed decimal places
STEP	Setting step size
T	Initialization values for temperatures
MIN	Default setting of temperature's lower limit
MAX	Default setting of temperature's upper limit
NOBG	No button background
MASK	Masking displayed buttons
INTERN	Direct connection with internal RTR
RDRQ	Read Request
PIN	In case "Use PIN" is selected, an individual password can be assigned using PIN

Complex circuit element to send the set points for the room temperature control.

W (in pixels) determines the width of the button's surface.

Using **TO**, you can determine after how much time the display returns to its standard position.

DC defines the displayed decimal places.

STEP determines the step size for adjusting the value between MIN and MAX.

Use T to initialize the temperatures
(Syntax: T=T1:T2:T3:T4)

MIN determines lower limit of the respective temperatures
(Syntax: MIN=T1:T2:T3:T4)

MAX determines upper limit of the respective temperatures
(Syntax: MAX=T1:T2:T3:T4)



NOBG eliminates the button's surface and the display is visualized directly on the background.

The masking will be conducted as follows:
(Syntax: 0=showing; 1=masking out) masking sequence:
MASK=Comfort:StandBy:Night:Protection (in case INTERN is selected, Protection will be automatically masked out).

In case the internal control is used and the set point defaults for the Touch_IT are activated, a communication via GA is unnecessary, as soon as **INTERN** is set.

RDRQ sent a read request at start-up for the used widgets. This parameter only works when Communication Address and Receive Flag are set.

If "Use PIN" is selected, the default master password will be used in case **PIN** is not set. Using **PIN**, an individual password can be assigned.

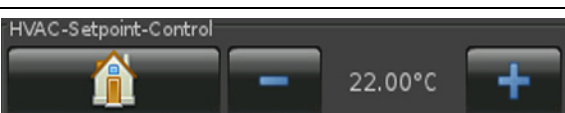
Examples	Element Name; Format
	HVAC-Setpoint-Control; TO=5; DC=2; MIN=7:15:18:15; MAX=7:17:20:30; T=7:15:18:22; INTERN;
	HVAC-Setpoint-Control; TO=5; DC=2; MASK=0101; MIN=7:15:18:15; MAX=7:17:20:30; T=7:15:18:22;
	HVAC-Setpoint-Control; TO=5;DC=2;MASK=1000; MIN=7:15:18:15; MAX=7:17:20:30; T=7:15:18:22;
	In order to activate temperature defaults select the respective circuit element. The displayed control element changes temporarily. The user can set manual defaults.

2.14.2 HVAC Mode-Control

ETS Objects		
Range of values	-	
Input	Feedback	2 Byte
Output	HVAC-Mode	1 Byte

Format	
W	Determines width of display's surface
FAN	Controlling ventilation
TSET	Shifting set point
NOBG	No button background
MASK	Masking displayed buttons
INTERN	Direct connection with internal RTR
RDRQ	Read Request
PIN	In case "Use PIN" is selected, an individual password can be assigned using PIN

Simple circuit element to send the HVAC modi and to display the room temperature.

W (in pixels) determines the width of the button's surface.

NOBG eliminates the button's surface and the display is visualized directly on the background.

The masking will be conducted as follows:
(Syntax:0=showing; 1=masking out) masking sequence:
MASK=Protection:Night:StandBy:Comfort:Automatic

In case the internal control is used and the selection for the Touch_IT is activated, a communication via GA is unnecessary, as soon as **INTERN** is set.



FAN changes the display of the control element. Use it only in combination with INTERN. Use it to control the ventilation. (Depends on the parameter setting of the controller page fan.)

TSET changes the display of the control element. Use it only in combination with INTERN. Use it to raise or to lower the comfort temperature. (Depends on the parameter setting of the setpoint adjustment range.)

RDRQ sent a read request at start-up for the used widgets. This parameter only works when Communication Address and Receive Flag are set.

If "Use PIN" is selected, the default master password will be used in case **PIN** is not set. Using **PIN**, an individual password can be assigned.

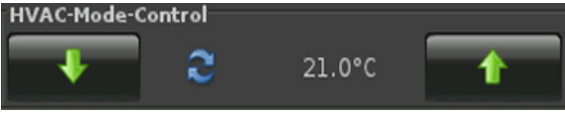
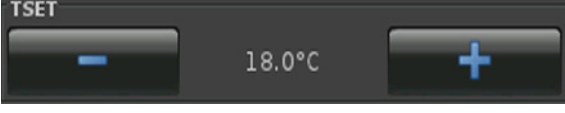

Examples	Element Name; Format
	HVAC-Mode-Control; INTERN;
	TSET; TSET; INTERN;
	FAN; FAN; INTERN;

2.14.3 HVAC Mode-Control-Text

ETS Objects	
Range of values	-
Input	Feedback 2 Byte
Output	HVAC-Mode 1 Byte

Format	
W	Determines width of display's surface
TSET	Shifting set point
NOBG	No button background
MASK	Masking displayed buttons
INTERN	Direct connection with internal RTR
RDRQ	Read Request
PIN	In case "Use PIN" is selected, an individual password can be assigned using PIN

Simple circuit element to send the HVAC modi and to display the room temperature.

W (in pixels) determines the width of the button's surface.

NOBG eliminates the button's surface and the display is visualized directly on the background.

The masking will be conducted as follows:
(Syntax:0=showing; 1=masking out) masking sequence:
MASK=Protection:Night:StandBy:Comfort:Automatic

In case the internal control is used and the selection for the Touch_IT is activated, a communication via GA is unnecessary, as soon as **INTERN** is set.

TSET changes the display of the control element. Use it only in combination with **INTERN**. Use it to raise or to lower the comfort temperature. (Depends on the parameter setting of the setpoint adjustment range)

RDRQ sent a read request at start-up for the used widgets. This parameter only works when Communication Address and Receive Flag are set.

If "Use PIN" is selected, the default master password will be used in case **PIN** is not set. Using **PIN**, an individual password can be assigned.

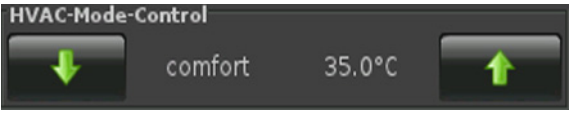
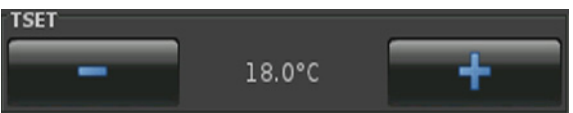
Examples	Element Name; Format
	HVAC-Mode-Control;
	TSET; TSET; INTERN;



2.14.4 HVAC-Fan-Control

ETS Objects		
Range of values	0 .. 3	
Output	Fan Speed	1 Byte
Input/Output	Switch	1 Bit

Format	
W	Determines width of display's surface
NOBG	No button background
INTERN	Direct connection with internal RTR
RDRQ	Read Request

Element for sending a 1-byte value.
Three steps (1, 2, 3).

W (in pixels) determines the width of the button's surface.
With the 1-bit-output, you can switch to manual fan speed setting. This is also possible from the bus.

NOBG eliminates the button's surface and the display is visualized directly on the background.

RDRQ sent a read request at start-up for the used widgets.
This parameter only works when Communication Address and Receive Flag are set.

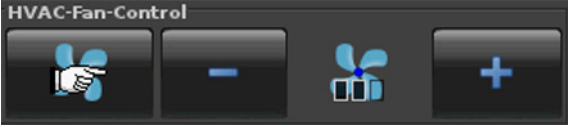
Examples	Element Name; Format
	HVAC-Fan-Control;
	When you press setting, the fan can be adjusted in three steps.



2.14.5 1-Byte-Timer-Profile HVAC

ETS Objects		
Range of values	0...255	
Input	-	-
Output	Profile	1 Byte
Input/Output	Profile Enable	1 Bit

Format	
W	Determines width of display's surface
IMG	Choosing an image
OVRTO	Determines the time (in minutes) until manual settings are overwritten
NOBG	No button background
PIN	In case "Use PIN" is selected, an individual password can be assigned using PIN
PPIN	In case "Use PIN" is selected, an individual password for the secondary function can be assigned using PPIN

Complex element to send a 1-byte value 0...255 in a set time allowance.

W (in pixels) determines the width of the display's surface.

OVRTO determines the span of time, after which the settings made manually by the user are overwritten by the values set in the time table. (in minutes)

NOBG eliminates the button's surface and the display is visualized directly on the background.



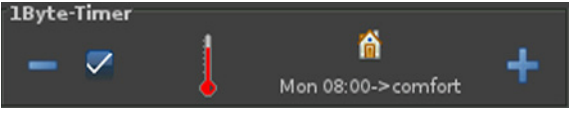
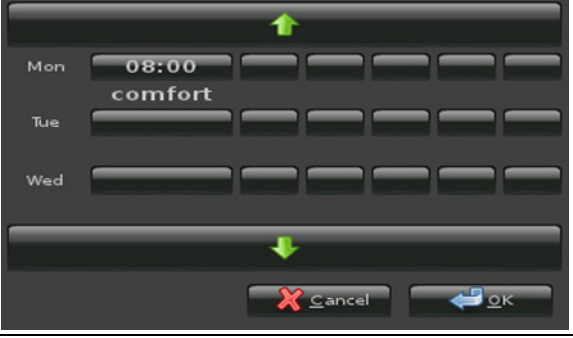
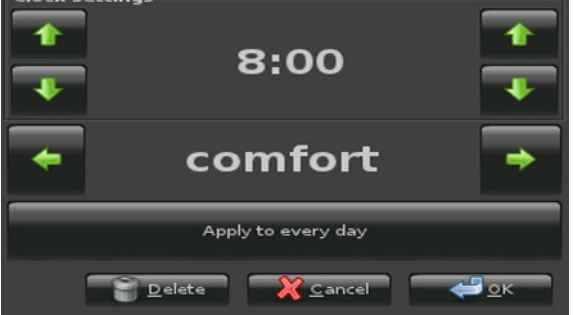

If "Use PIN" is selected, the default master password will be used in case **PIN** is not set. Using **PIN**, an individual password can be assigned.

In case "Use PIN" is selected, an individual password can be assigned using **PPIN**, which protects the secondary functions of this object.



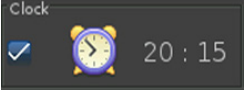

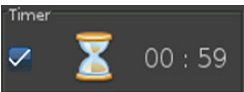
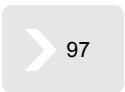
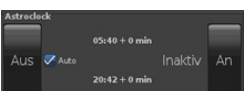



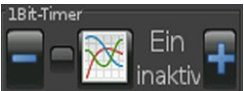

Examples	Element Name; Format
	<p>1Byte-Timer; IMG=thermometer.png; NOBG; OVRTO=1;</p>
	<p>Pressing the options button will open a dialog box where time allowances can be set, according to which the ETS object is then controlled.</p>
	<p>It is possible to determine up to 6 times for each weekday, at which freely selectable values out of the object value range can be sent.</p>

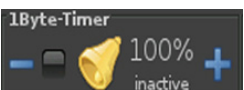

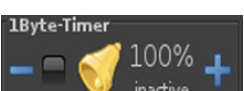
2.15 Overview Time / Date Elements

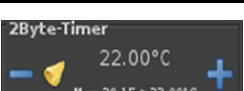
Image	Element Number	Element Type	Page
	Range of Values	Format	
	60	Alarmclock	 96
	0/1	W,ALTO,SILENT,NOBG,RDRQ,PIN,PPIN	
	61	Alarmtimer	 97
	0/1	W,ALTO,SILENT,NOBG,RDRQ,PIN,PPIN	
	59	Astroclock	 98
	0/1	INV,L0,L1,B0,B1,PIN,PPIN	

There are also different timer profiles.



	62	1-Bit-Timer-Profile	 19
	63	1-Byte-Timer-Profile 0 .. 100%	 39
	64	1-Byte-Timer-Profile 0 .. 255	 40
	66	2-Byte-Float-Timer-Profile	 57
	65	1-Byte-Timer-Profile HVAC	 94

2.15.1 Alarmclock

ETS Objects		
Range of values		
Input/Output	Alarm clock Enable	1 Bit
Output	Alarm clock	1 Bit

Format	
W	Determines width of display's surface
ALTO	Time allowance for alarm duration
SILENT	Silent alarm
NOBG	No button background (only possible in special modification)
RDRQ	Read Request
PIN	In case "Use PIN" is selected, an individual password can be assigned using PIN
PPIN	In case "Use PIN" is selected, an individual password for the secondary function can be assigned using PPIN

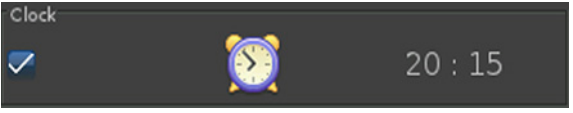
Timer element to send a 1-bit value.
Can additionally be activated from the bus.
Use **ALTO** to determine length of the alarm. (in seconds)
Use **SILENT** to trigger a silent alarm.
RDRQ sent a read request at start-up for the used widgets. This parameter only works when Communication Address and Receive Flag are set.
If "Use PIN" is selected, the default master password will be used in case **PIN** is not set. Using **PIN**, an individual password can be assigned.
In case "Use PIN" is selected, an individual password can be assigned using **PPIN**, which protects the secondary functions of this object.

Examples	Element Name; Format
	Clock; ALTO=5;
	Clock; SILENT;
	Pressing the time button will open a dialog box where time allowances can be set, according to which the ETS object is then controlled. Format (hh:mm)





2.15.2 Alarmtimer

ETS objects		
Range of values		
Input/Output	Alarm timer Enable	1 Bit
Output	Alarm timer	1 Bit

Format	
W	Determines width of display's surface
ALTO	Time allowance for alarm duration
SILENT	Silent alarm
NOBG	No button background (only possible in special modification)
RDRQ	Read Request
PIN	In case "Use PIN" is selected, an individual password can be assigned using PIN
PPIN	In case "Use PIN" is selected, an individual password for the secondary function can be assigned using PPIN

Timer element to send a 1-bit value.
Can additionally be activated from the bus.
Use **ALTO** to determine length of the alarm. (in seconds)
Use **SILENT** to trigger a silent alarm.
RDRQ sent a read request at start-up for the used widgets. This parameter only works when Communication Address and Receive Flag are set.
If "Use PIN" is selected, the default master password will be used in case **PIN** is not set. Using **PIN**, an individual password can be assigned.
In case "Use PIN" is selected, an individual password can be assigned using **PPIN**, which protects the secondary functions of this object.

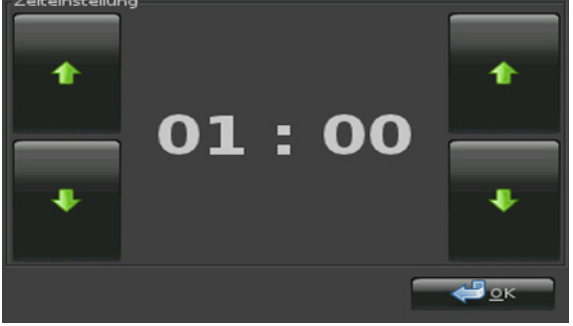
Examples	Element Name; Format
	Timer; ALTO=5;
	Timer; SILENT;
	Pressing the time button will open a dialog box where time allowances can be set, according to which the ETS object is then controlled. Format (mm:ss)





2.15.3 Astroclock

ETS objects		
Range of values		
Input/Output	Astroclock Enable	1 Bit
Output	Astroclock	1 Bit



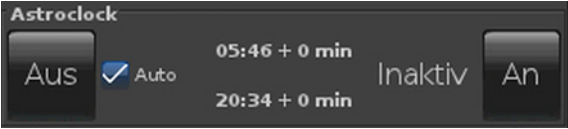



Format	
INV	Value Output invert
L0	Text default for display on "0"
L1	Text default for display on "1"
B0	Text default for button on "0"
B1	Text default for button on "1"
PIN	In case "Use PIN" is selected, an individual password can be assigned using PIN
PPIN	In case "Use PIN" is selected, an individual password for the secondary function can be assigned using PPIN

Timer element to send a 1-bit value.
Can additionally be activated from the bus.
Use **INV** to invert the output.
In the time window between sunrise and sunset (day), the default setting for the output is '0'.
If "Use PIN" is selected, the default master password will be used in case **PIN** is not set. Using **PIN**, an individual password can be assigned.
In case "Use PIN" is selected, an individual password can be assigned using **PPIN**, which protects the secondary functions of this object.

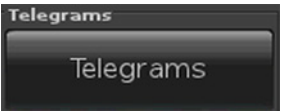
Examples	Element Name; Format
	<p>Astroclock; L0=Inaktiv;L1=Aktiv;B0=Aus;B1=An;</p>
	<p>Astro Clock needs settings of the geographic coordinates and the defined sunset-height (-0.8° for the geometric twilight, -6° for the civil twilight, -12° for the nautic twilight). Optional settings are time-offsets for sunrise and sunset in minutes. The correct times need correct settings of the time, the timezone and the use of DST (Daylight Saving Time).</p>

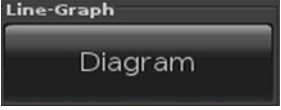

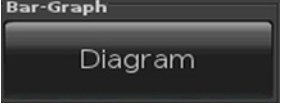
2.16 Overview Datalogging

Image	Element Number	Element Type	Details
	Range of Values	Format	Page
	95	Telegrams	 100
		OBJS,LABEL,PIN	
	96	Line-Graph	 101
		DGRM,LABEL,PIN	
	97	Bar-Graph	 102
		DGRM,LABEL,PIN	



2.16.1 Telegrams

ETS Objects	
Range of values	
Input	
Input/Output	

Format	
OBJS	
LABEL	Text default for button
PIN	In case "Use PIN" is selected, an individual password can be assigned using PIN

For the telegrams-function the datalogging with the SD-Card must be enabled.

OBJS filters the objects which should be visualized by their Object Number from the Log file. The item numbers are separated with a comma.

LABEL defined what is shown on the Button.

If "Use PIN" is selected, the default master password will be used in case **PIN** is not set. Using **PIN**, an individual password can be assigned.

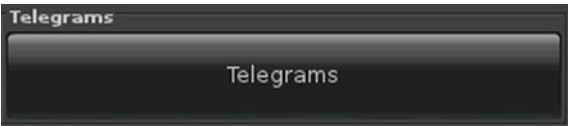
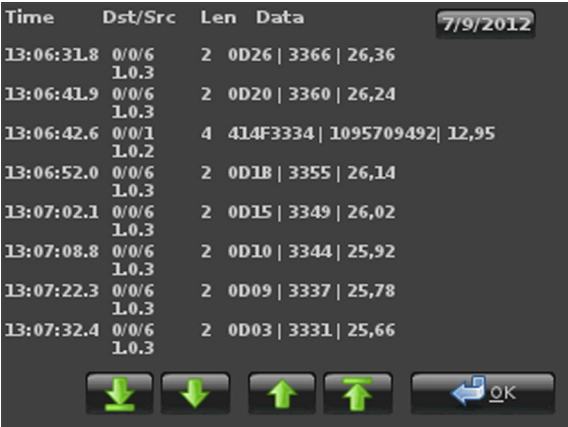
Examples	Element Name; Format
	Telegrams; LABEL=Telegrams;OBJS=64,72;
	<p>In this example, object 64 with the group address 0/0/1.</p> <p>In this example, object 72 with the group address 0/0/6.</p>



2.16.2 Line-Graph

ETS Objects	
Range of values	
Input	
Input/Output	

Format	
DGRM	Diagram parameters
LABEL	Text default for button
PIN	In case "Use PIN" is selected, an individual password can be assigned using PIN

For the diagram-function the datalogging with the SD-Card must be enabled.

DGRM specifies the parameters for the graphs. (see below)

LABEL defined what is shown on the Button.

If "Use PIN" is selected, the default master password will be used in case **PIN** is not set. Using **PIN**, an individual password can be assigned.

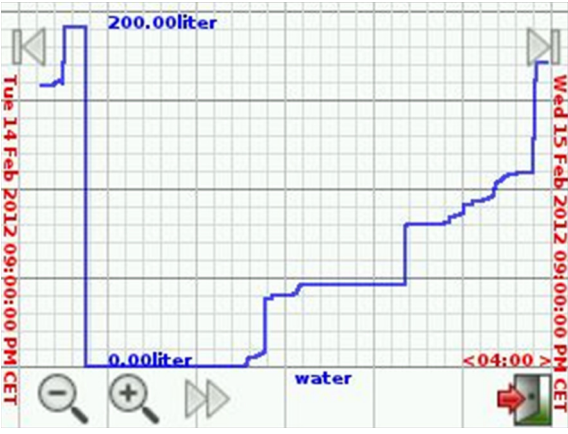
Examples	Element Name; Format
	Line-Graph; LABEL=Line-Graph;DGRM=6/4/3,14,water,liter,blue;
	<p>Up to three curves can be displayed in one diagram. The data to display is defined as a list in the DGRM option separated by a ",".</p> <p>DGRM=a/b[/c],t,n,p,c:.... Object a/b or a/b/c of type is displayed t = DPTtype 12, 13 or 14 according KNX-Standard n = Name to display with the curve p = Postfix to display with the values on the coordinates. c = Color to display the curve</p> <p>Only the groupaddress and the type are mandatory, the rest can be omitted. Example: DGRM=1/2/2,12:1/2/3,12:1/2/4,12</p>



2.16.3 Bar-Graph

ETS Objects	
Range of values	
Input	
Input/Output	

Format	
DGRM	Diagram parameters
LABEL	Text default for button
PIN	In case "Use PIN" is selected, an individual password can be assigned using PIN

For the diagram-function the datalogging with the SD-Card must be enabled.

DGRM specifies the parameters for the graphs. (see below)

LABEL defined what is shown on the Button.

If "Use PIN" is selected, the default master password will be used in case **PIN** is not set. Using **PIN**, an individual password can be assigned.

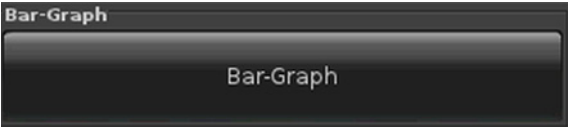
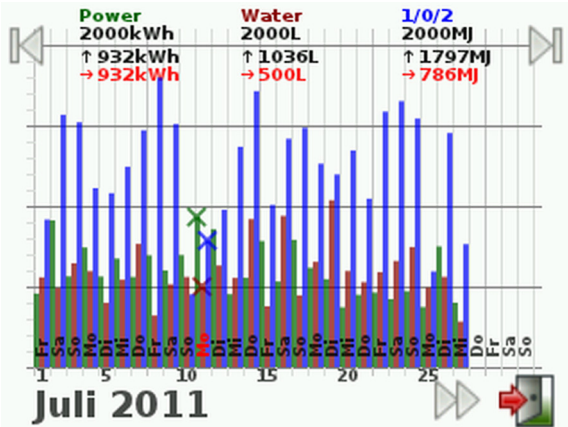
Examples	Element Name; Format
	<p>Bar-Graph; LABEL=Bar-Graph;DGRM=1/0/0,14056,Power,kWh,green:1/0/1,14076,Water,L,red:1/0/2,14043,1/0/2,blue;</p>
	<p>Up to three curves can be displayed in one diagram. The data to display is defined as a list in the DGRM option separated by a ",".</p> <p>DGRM=a/b[/c],t,n,p,c:.... Object a/b or a/b/c of type is displayed t = DPTtype 12, 13 or 14 according KNX-Standard n = Name to display with the curve p = Postfix to display with the values on the coordinates. c = Color to display the curve</p> <p>Only the groupaddress and the type are mandatory, the rest can be omitted. Example: DGRM=1/2/2,12:1/2/3,12:1/2/4,12</p>



3 System Settings

The following section describes the internal system setting of the Touch_IT in detail.

3.1 Main

In the main display of the system page, the following settings can be set directly on the Touch_IT.

- Time and date
- Standby
- Audio signals
- Fonts
- System & SD-card
- Layouts & language

These settings can be changed and adjusted to individual defaults by the user at any time.



3.2 Time & Date

Use the time zone setting for localization. It is required also for logical operations. (For more information see chapter 10, miscellaneous)

An automatic switch to daylight saving time can be activated. The clock will then shift automatically.

As soon as the communication objects 192 (System Time) and 193 (System Date) are connected, the Touch_IT can either be used as a timer in the bus, or be adjusted by a timer.



3.3 Standby

Two brightness settings can be defined.

- Standard operation
- Screen saver operation

Additionally, two time allowances can be set.

- Screen saver operation
- Standby

If the setting is 0, the respective function will be inactive.

As soon as a minute default between 1 and 60 is set, the respective function will be effected after this time has elapsed.

The screenshot shows the 'Standby' settings interface. It contains four adjustable sliders:

- Helligkeit im Normalbetrieb:** Set to 100.
- Bildschirmschoner nach (min):** Set to 1.
- Helligkeit im Bildschirmschonbetrieb:** Set to 32.
- Standby nach (min):** Set to 10.

At the bottom of the screen, there are two buttons: a red 'X' button labeled 'Abbrechen' and a blue arrow button labeled 'OK'.

3.4 Audio Signals

The operation sound and the volume of the alarm sound can be defined individually.

Volume of click and alarm can vary within the scope of 0 to 10.

The frequency of the operation sound can set between 100 and 8000 Hz.

The duration or running time of the operation sound can be adjusted within the scope of 10 to 300 ms.

The screenshot shows the 'Audio Signals' settings interface. It contains four adjustable sliders:

- Lautstärke Klick:** Set to 10.
- Klick Frequenz:** Set to 1200.
- Klick Länge in ms:** Set to 200.
- Lautstärke Alarm:** Set to 10.

At the bottom of the screen, there are two buttons: a red 'X' button labeled 'Abbrechen' and a blue arrow button labeled 'OK'.

3.5 Fonts

The element sizes that are selectable in the ETS can be freely parameterized.		
ETS (Element Size)	↔	Touch_IT
Small	↔	small
Normal	↔	normal
Large	↔	large
X-Large	↔	extra large

It is also possible to change

- Frame label
- Page name
- Menu label

The alterable parameters are

- Type face
- Type form
- Type size

3.6 System & SD Card

All these settings can optionally be

- written to the internal memory
- downloaded from the intern memory
- reset to factory setting

The programming button is additionally materialised in the software. It can be activated on demand, using the „P“ button.

In case data logging is carried out on the Touch_IT, an SD card has to be included. After inclusion, the free memory space will be displayed and the logging starts automatically.

3.7 Layouts & Language

In the overview below you can find examples of different themes and navigation options to choose from.

Currently, the following languages are supported:

- German
- English
- Hebrew
- Italian
- Chinese
- Spanish
- Turkish
- French
- Russian

Please note that your system software as well as ETS must support these languages in order to ensure a proper use.

If the screen saver operation is activated, there are different screen savers to choose from.

- Analog clock
- Time
- Slideshow
- Static screen



Theme



Navigation & Layout



4 Screensaver

There are four different screen saver types available.

- Analog clock (displays analog time and date in front of the image uploaded to the background)
- Time (displays digital time and date on a black background)
- Static screen (displays uploaded image)
- Slideshow (displays uploaded images in an infinite loop)

The screen saver types 1 to 3 are identical except for the fact that they have different predefined default settings. The customer is free to create an individual screen saver. The parameter setting is carried out using ETS and will be described more detailed (see below).

4.1 ETS

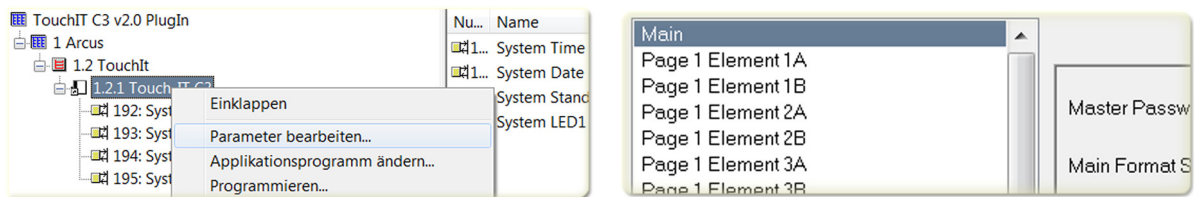

4.2 Parameter Setting

ETS Objects		
Range of values	-	
Input/Output	System Time	3 Byte
	System Date	3 Byte
	Input, external Temp.	2 Byte

Additional Parameters	
SCRBG	Defaults for background
SCRACLK	Defaults for analog clock
SCRDCLK	Defaults for digital clock
SCRDATE	Defaults for date
SCRTEMP	Defaults for temperature

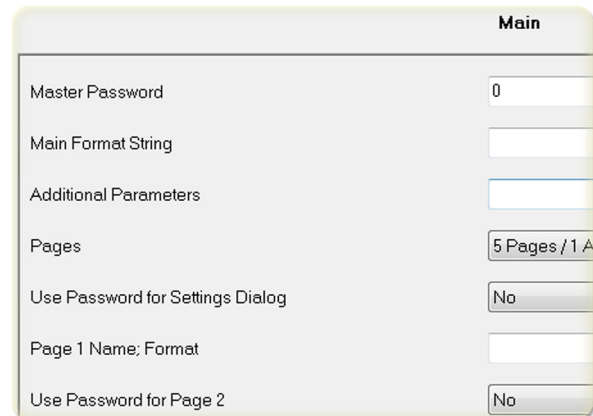

If no static image is used, the background color can be defined using SCRBG. The color selection can be entered either in HTML color code or in HEX RGB code. (SCRBG=#445578 or SCRBG=green)

Use SCRACLK to set the parameters of the analog time.

For this purpose, X- / Y- position, as well as the width, need to be set. The analog clock must be considered as a rectangular surface enclosing the circular shape. (SCRACLK=100,50,80)

Use SCRCLK to set the parameters of the digital time.

Positioning can be carried out as in the case of the analog time. Additionally, the font color can be defined. (SCRCLK=200,0,80,lightgrey oder SCRCLK=200,0,80,#4433FA)

Use SCRDATE to set the date just like in the case of the digital time.

(SCRDATE=200,0,80,lightgrey oder SCRDATE=200,0,80,#4433FA)

Use SCRTEMP to visualize the internally used temperature. The parameter setting of SCRTEMP can be carried out as in the case of the digital time, with an additional adjustment of the decimal places.

(SCRTEMP=200,40,80,1,#334489 oder SCRTEMP=200,40,80,1,purple)

Examples



selected screen saver: static image

SCRACLK=10,10,100
 SCRCLK=200,120,100,black
 SCRDATE=210,160,80,#000000
 SCRTEMP=220,200,60,1,white



selected screen saver: static image

SCRBG=#0735fe
 SCRCLK=200,120,100,#000000
 SCRDATE=210,160,80,#FFFFFF
 SCRTEMP=220,200,60,1,#FDFA00



factory setting of the analog clock

In case one element is not to be used, it can be deactivated using „=N“.

The overall size of the display is 320x240px.

The origin of all elements (including the entire display itself) is the upper left corner.
 All elements are positioned in relation to the origin in the upper left corner.



5 RTR

This document features three major sections. The first section contains descriptions of rather general characteristics which are related to multiple objects and parameters.

5.1 General Information

5.1.1 Structure of this Document

The different subsections of this first section are called "articles". They appear in the respective parameter and object descriptions and every parameter and every object includes a functional description.

Some of them have examples marked by ,

use cases are marked by ,

and important notes marked by .

Also, there are links to other sections with further information corresponding to the respective entry.

In the second section, all parameters are listed and described. In the third section you find a description of all objects related to the Room Temperature Controller. At the end of this document there is an index where all object and parameter names are listed including name and page number.

5.1.2 How to read this

Please use the ETS application.

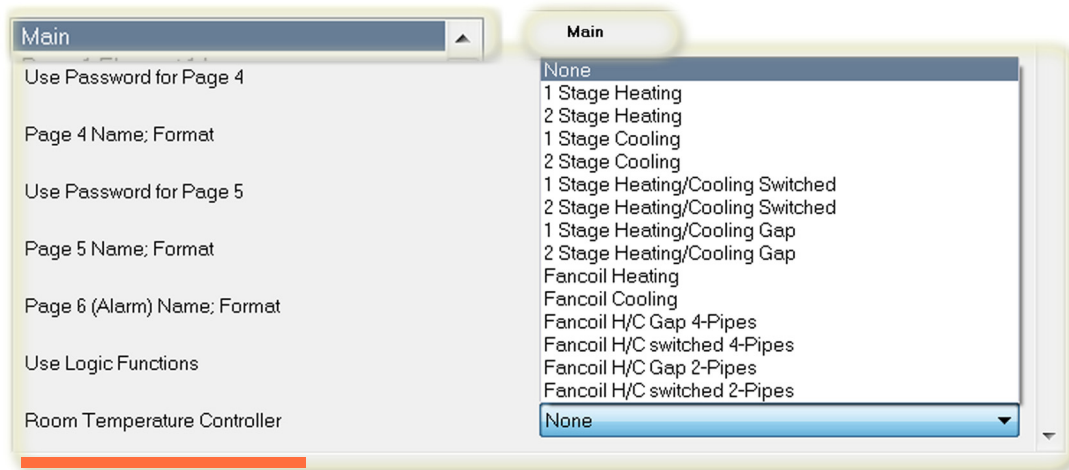

If there are any ambiguities with a parameter or an object, please look it up in the index at the end and go to the corresponding site with the description. In the section General Information, there is a schematic diagram of the Room Temperature Controller.

If a parameter is referenced in the text, it has the following structure:

Parameter "Controller Type (Temp. Controller Heating / Cooling), Page 123"

The string in the brackets stands for the tab in the ETS parameter of the device (see figure). [4].

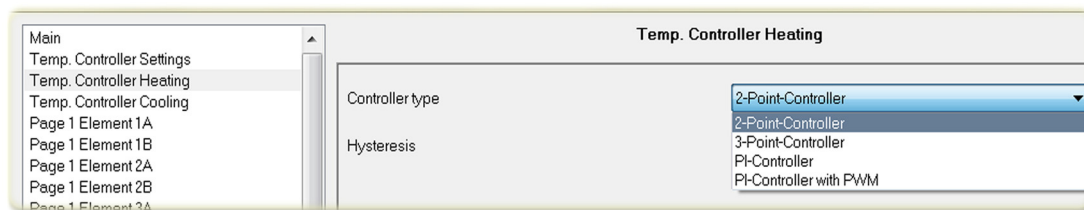

The following schematic diagram shows a general overview of the Room Temperature Controller (RTC). It provides an overview, but it doesn't show every detail. For more details, see the list of all parameters and objects including their descriptions. For some special parts, see the following sections.

5.1.3 Overview

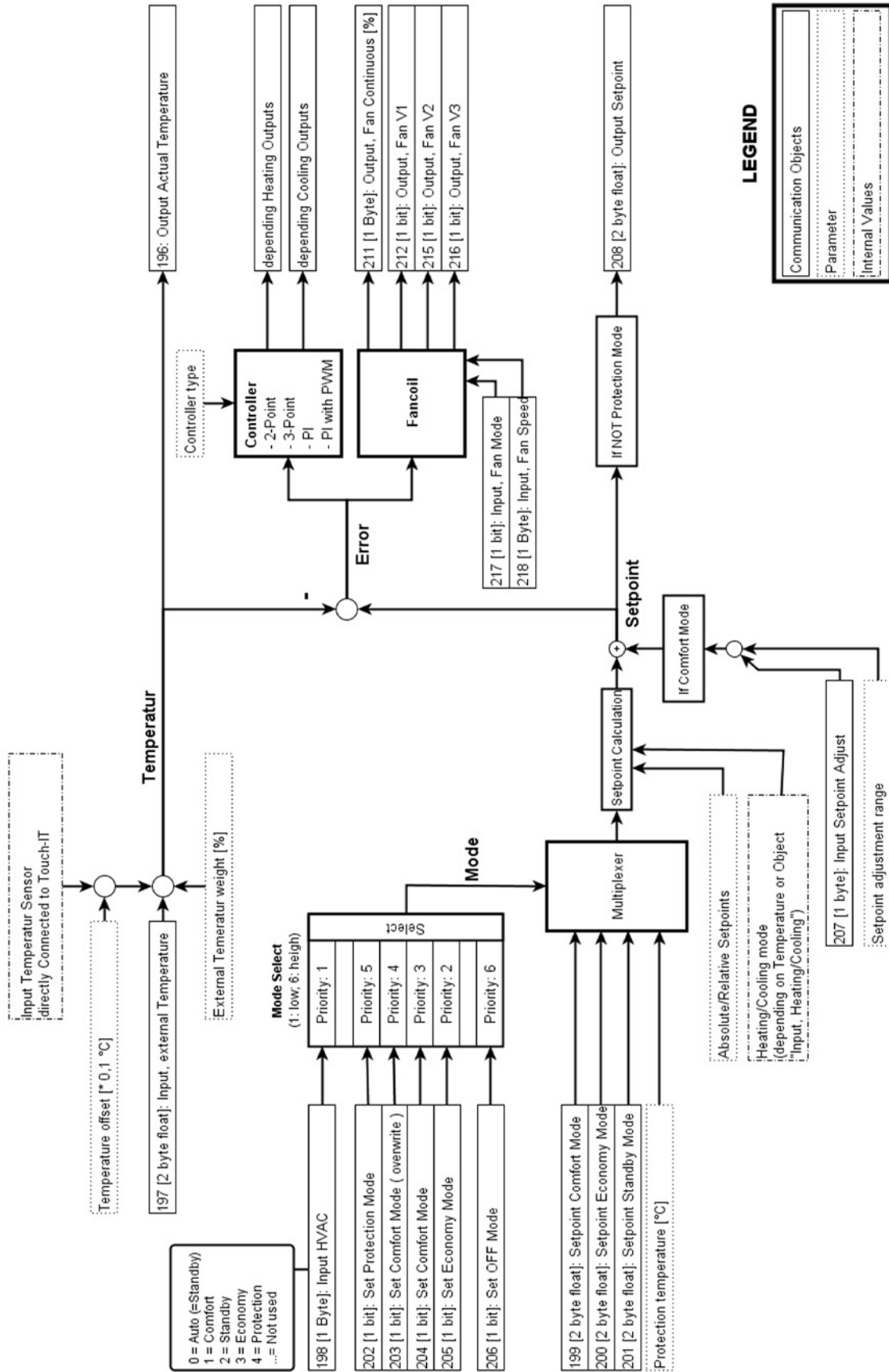

5.1.4 Important

- Check the parameter "External Temperature weight [%]" (If no temperature sensor is directly connected to the device, the parameter "External Temperature Weight [%] (Temp. Controller Settings), Page 125 must be 100!).
- Mode selection (comfort, economy, ...) by the different objects is prioritized
- If PI-controller is poorly or wrongly parameterized, there is the danger of continual oscillation
- The controller does not start if there is no temperature input (If both the internal and the external one are used, both must have readings.)
- If the integration time for a PI-Controller is set to 0, it will turn into a simple P-Controller
- There is the possibility to directly control the RTC from the HVAC element types without any object or group address. See "Device-internal communication to control the RTC"

5.1.5 Device-Internal Communication to Control the RTC

Various HVAC element types have the format string INTERN, which allows to directly control the Room Temperature Controller (RTC) without using the object. Only one of the different element types can have the INTERN format. Otherwise, only one element type will be evaluated. This allows to directly define the different setpoints via the element "HVAC setpoint control" without using any group address or object.

For more information see Chapter 2 Elements.

5.1.6 PI-Controller Set Up

5.1.6.1 Adjusting the PI Controller

There are different systems for heating and cooling rooms. This is done using water, oil or air in various designs, such as in-floor heating, cooling ceilings, and radiators. The diversity of these combinations and the design of the room, such as the placement of radiators and the types of windows, play an important factor in the correct adjustment of the PI Controller. Therefore, it is not possible to specify a general PI parameter set. This description deals more or less with practical results of properly planned and installed heating units. If a system is improperly installed, it can be either slow, need too long to reach the desired temperature or fluctuate above or below the selected temperature.

Heating Type	Pre-programmed Value		Controlling Type	PWM Cycle Type
	Proportional band	Integration time		
Warm Water	5 °C	150 minutes	steady /PWM	15 Min or 2-3 Min if smaller and faster heater
In-Floor Heating	5 °C	240 minutes	PWM	15-20 min
Electric Heating	4 °C	100 minutes	PWM	10-15 min
Heating Ventilation	4 °C	90 minutes	steady	-
Split Unit	4 °C	90 minutes	PWM	10-15 min
Cooling Type				
Cooling Ceiling	5 °C	240 minutes	PWM	15-20 min
Air-Conditioning	4 °C	90 minutes	steady	-
Split unit	4 °C	90 minutes	PWM	10-15 min

- Just a small change in the parameter can result in a noticeable change in the controlling performance.
- The above mentioned values are based on experience and it is suggested to use them in the adjustment of the controlling parameters..

For a more detailed description of the PI controller process, please refer to relevant technical literature. Two other example methods to determine the controller's parameter are the Ziegler-Nichols tuning method and the pole compensation technique. These are only examples and there are more methods. Which method to use always depends on the use case

5.1.6.1 General Basic Rules

Parameter Specifications	Effect
Lower Proportional Band	Large fluctuation (perhaps continual fluctuation), quick adjustment to set point
Higher Proportional Band	Little or no fluctuation, but slow adjustment
Short Integration Period	Quick adjustment of controlling modulations (dependent on conditions), danger of continual oscillation
Long Integration Period	Slow adjustment of controlling modulations

5.1.7 Setpoint handling

The setpoints are predefined in the parameter settings and are changeable via the corresponding objects. As long as the controller is not in the protection mode, the actual setpoint is sent to the object "Output, Setpoint".

! The different setpoints are saved if changed manually or over the corresponding objects and stay saved also if the device is reprogrammed via ETS. To reset the setpoints of the parameter on an already RTC-programmed device, it is necessary to program the device with disabled RTC and then reprogram it with the desired settings. Especially if changing the RTC from absolute to relative mode this reset should be done once.

5.1.7.1 Setpoint Adjustment

If the controller is in comfort mode, it is possible to temporarily adjust the setpoint within the range determined by the parameter "Setpoint Adjustment Range (Temp. Controller Settings), Page 128" to the time set in the parameter "Overwrite Timeout [minutes] (Temp. Controller Settings), Page 127" by the object "Input, Setpoint Adjust".

5.1.7.2 Absolute vs. Relative Setpoint

It is possible to set the calculation of the setpoints relative to the comfort setpoint or absolute in °C. This is selectable using the parameter "Absolute / Relative Setpoints (Temp. Controller Settings), Page 119" which determines how the values of the parameter and the object-related setpoint are interpreted. The setpoints for the cooling part are calculated internally by mirroring the set values at the comfort setpoint.

e.g. Setpoint is absolute and a heating/cooling controller type is installed.

Comfort setpoint is set to 20 °C and the economy setpoint for heating is set to 15 °C. In this case, the setpoint for economy cooling will be calculated to 25 °C (20 °C + (20 °C - 15 °C)).

e.g. Setpoint is relative and a heating/cooling controller type is installed. Comfort setpoint is set to 20 °C and the relative economy setpoint for heating is set to 2 °C. In this case, the setpoint for economy cooling is calculated to 22 °C (20 °C + 2 °C) and for heating it is calculated to 18 °C (20 °C - 2 °C).

5.1.7.3 Heating / Cooling Gap

If controller types with a gap are used, all setpoints are pushed apart relative to the comfort setpoint by the set value at the parameter "Heating / Cooling Bandgap (Temp. Controller Settings), Page 126" (the spacing between the comfort setpoints of heating and cooling corresponds to this value), but the output value at the object "Output, Setpoint" is not affected by the gap value. This means that the setpoint calculation with the gap is carried out only internally and will not be sent.

e.g. Setpoint is relative and a controller type with a gap is selected. The comfort setpoint is 20 °C, the relative setpoint for Stand-By is 5 °C, and the gap is set to 2 °C (setpoint adjust is not used!). In comfort mode, the output at the object "Output, Setpoint" is always 20 °C, no matter if heating or cooling. In economy mode, the output corresponds with the actual state (heating or cooling), i.e. 15 °C or 25 °C.

Internally, in heating state the controller uses 19 °C as setpoint for comfort mode and 14 °C as setpoint for stand-by mode. In cooling state it uses 21 °C as setpoint for comfort mode and 26 °C for stand-by mode.

5.1.7.4 Illustrated Examples

In the following, there are some illustrated examples for different setpoints.

Simple Heating Controller Type with Absolute Setpoints

A simple Heating controller, with absolute setpoints and without setpoint adjust. As one sees the setpoints are used as they are by the controller corresponding to the Mode. The values are also sent without changes to the Object "Output, Setpoint".

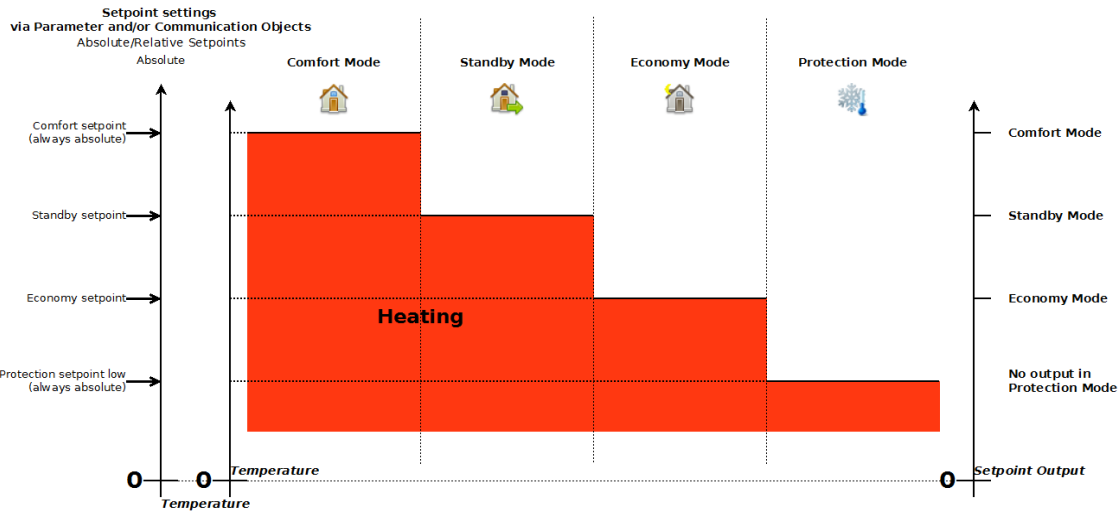

Heating / Cooling Switched Controller Type with Relative Setpoints

A switched heating / cooling controller with relative setpoints and without setpoint adjustment. As is shown, the set setpoints for economy and stand-by mode are relative to the comfort setpoint. The comfort setpoint, as well as both protection setpoints are always set absolute. The setpoints for cooling mode are calculated by mirroring the setpoints at the comfort setpoint. If the controller is in protection mode, there is no output of the setpoint on the object "Output, Setpoint".

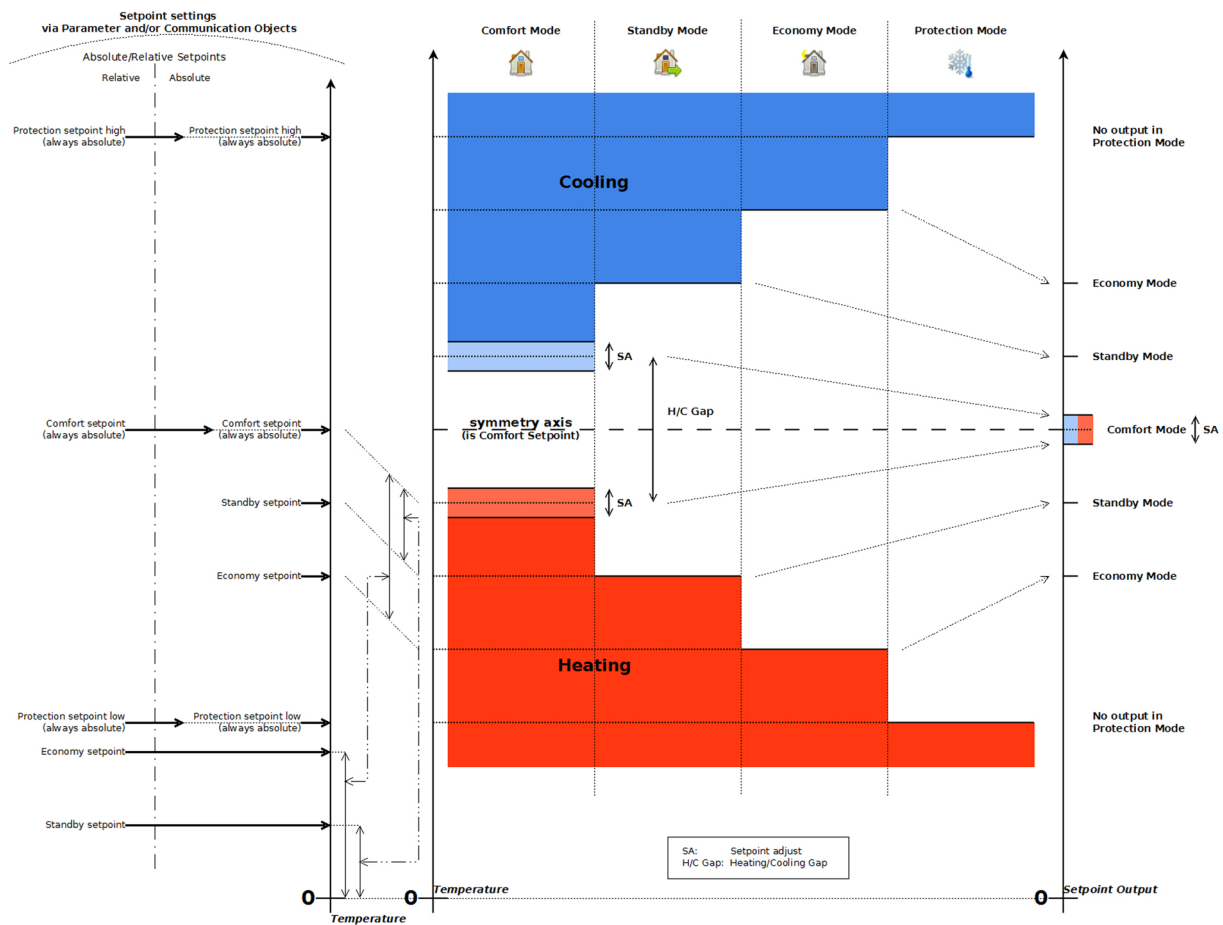

Heating / Cooling with Gap Controller Type, with Relative and Absolute Setpoints and Setpoint Adjustment

This figure shows an overview of a heating / cooling controller type with a heating/cooling gap and setpoint adjustment, as well as the setpoint input interpretation for absolute and relative setpoints and the output of these at the object „Output, Setpoint“.

As is shown, the gap causes all setpoints to be pushed apart relative to the comfort setpoint, but the output is still as if there were no gap. The setpoint adjustment is only available in comfort mode and is being output at the object. All relative and absolute setpoints for economy and stand-by are only set for heating. Subsequently, the setpoints for the cooling part are calculated by mirroring the values at the comfort setpoint.

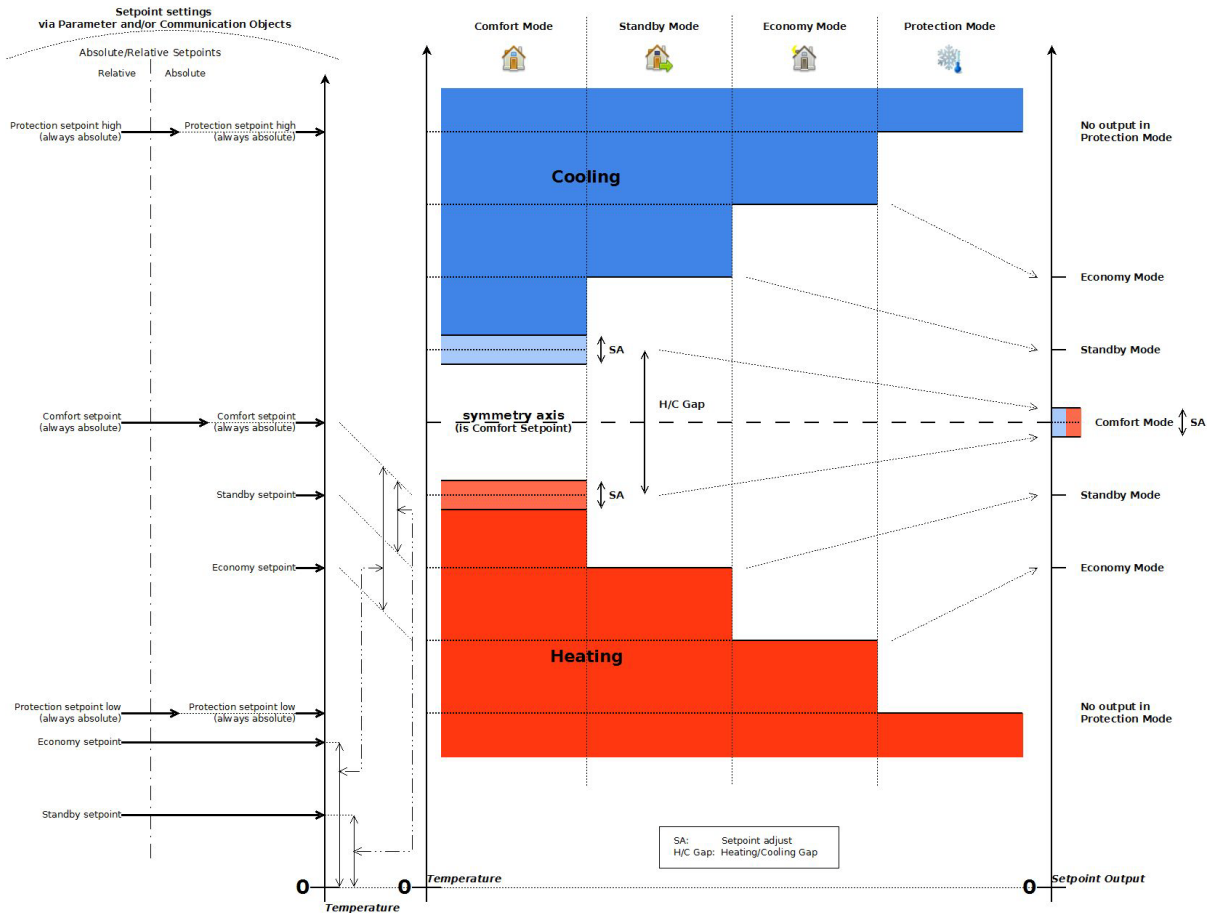

5.1.8 Room Temperature Controllers

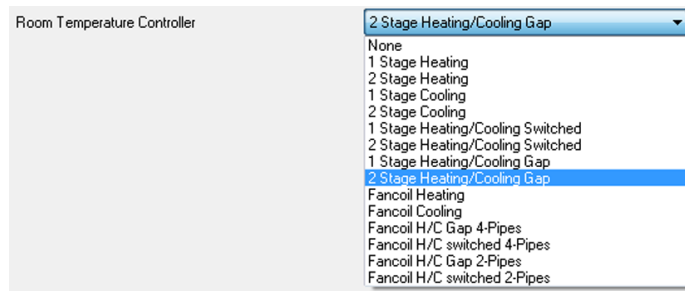

There are different selectable controller types with different functionalities. In the following, their different properties will be described. In most cases, a simple 1-stage heating should be sufficient.

5.1.8.1 Heating vs. Cooling controller

Heating

If a heating controller is used or the controller is in heating state (heating / cooling controller), and the actual temperature falls below the current setpoint (corresponding to the actual mode, e.g. stand-by), the controller, if enabled, starts heating, according to the used controller type (e.g. PI-Controllers, selectable in the parameters).

Cooling

Cooling mode works vice versa to the heating mode, so if the temperature rises over the current setpoint, the controller starts cooling.

5.1.8.2 One- vs. Two-Stage Controllers

One Stage

One-Stage controllers have only one controller that allows to control the current setpoint.

Two-stage

Two-stage controllers have two controllers, each separately configurable. The first stage controller controls on the current setpoint (depending on mode, setpoint adjustment and heating/cooling gap), the second stage controls the actual setpoint plus / minus the parameter "1st / 2nd Stage Bandgap (Temp. Controller Heating / Cooling), Page 119".

e.g. Comparison: see figure. 2-stage cooling controller in comfort mode, with comfort setpoint at 20 °C, no setpoint adjustment, no heating/cooling gap and parameter "1st / 2nd Stage Bandgap" is 2 °C. If the temperature exceeds 20 °C, the first stage starts to work and tries to reduce the temperature to 20 °C. If the temperature still rises and then exceeds 22 °C (20 °C + 2 °C), the second stage starts working and tries to keep the temperature below 22 °C.

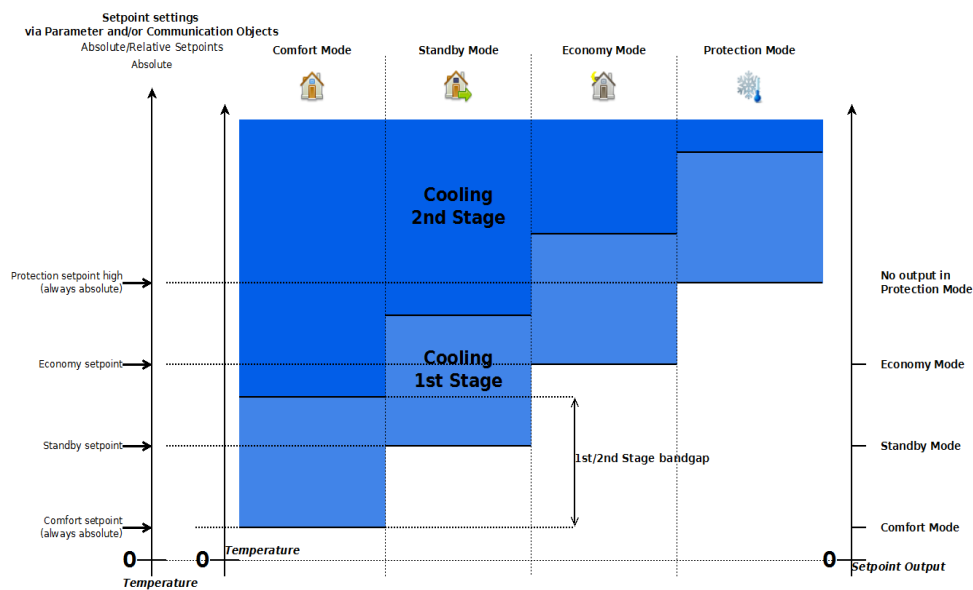

Use If there are solar panels used for heating and for cold days and there is also an electrical heater, the solar heater can be connected to the 1st Stage and the electrical one to the 2nd Stage. Now if the solar heater doesn't provide sufficient power, the electrical heater will switch on.

5.1.8.3 Heating / Cooling Switched vs. Gap Controller

Switched

If a switched controller type is selected, the heating or cooling mode needs to be set by the object "Input, Heating / Cooling". So if the controller is in heating mode and the exceeds the comfort setpoint, the controller does not switch automatically into the cooling mode. This must be done by the object.

Use Normally the switch signal is calculated from the long term mean value of the outdoor temperature.

Gap

The gap controller types have a gap between heating and cooling mode. If the temperature is within this gap, both controllers are inactive.

e.g. Heating/cooling controller with gap in comfort mode, with setpoint set to 20 °C and heating / cooling gap set to 4 °C. If the temperature is below 18 °C (20 °C - 4 °C / 2), the controller is heating. If the temperature is higher than 18 °C but below 22 °C, the controller is neither heating nor cooling. If the temperature is above 22 °C, the controller is cooling.

Fancoil

The fancoil controller types allow the control of fan coil units. It is possible to control 2 and 4 pipe units. It allows to control the fan speed via steady output or via three 1-bit objects for three different speeds. The fan can also be controlled by two objects, which allows one to change the fan speed manually for a limited time (Objects "Input, Fan Mode" and "Input, Fan Speed"). Furthermore, there is the possibility to set a Lead and Lag Time (via parameter "Fan Lead-Time [sec] (Controller Page Fan), Page 126" and "Fan Lag-Time [sec] (Controller Page Fan), Page 126") which allows to set a time before the fan starts and how long the fan runs afterwards, even if according to the calculation the fan should already be turned on or off. This makes it possible to e.g. use the remaining heat in the radiator after the controller is shut off.

General

The fan coil controller sets the control-value depending on the actual temperature and the Setpoint as follows: [5]:

$$\text{Fan Continuous}[\%] = \frac{(\text{setpoint} - \text{Temperature})}{\text{Controller Fan Proportional Part}}$$

[For the parameter description see "Controller Fan Proportional Part (Controller Page Fan), Page 121".]

The fan's continuous signal will then be output at the object "Output, Fan Continuous [%]" in a discretized form, as set by the parameter "Steady-Output Stepwidth [%]", the "Controller Fan Limit 1 [%] (Controller Page Fan), Page 120" and, if available, "Fan Steadyoutput Stepwidth [%] (Controller Page Fan), Page 126", as shown in the following figure..

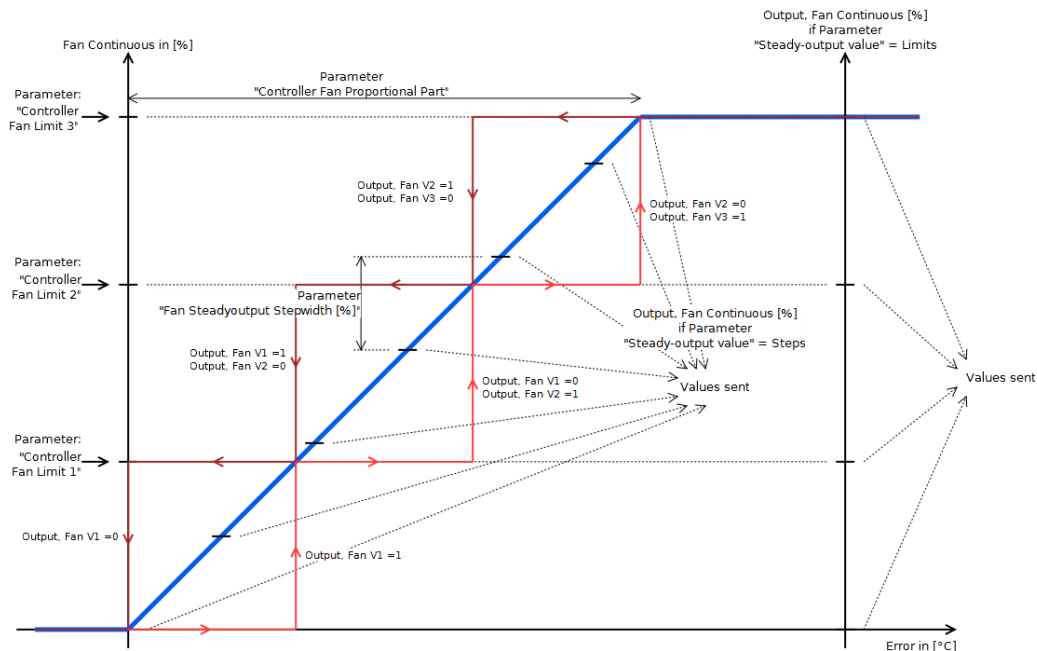

Manual Fan Control

It is possible to manually control the fan (1-byte Object "Output, Fan Continuous [%]" and the 1-bit Objects "Output, Fan VX"). The objects "Input, Fan Mode" and "Input, Fan Speed" make it possible to set the fan speed for the amount of time set by the parameter "Overwrite Timeout [minutes] (Temp. Controller Settings), Page 127" after which it returns to the actual value given by the controller. That can e.g. be used to switch off the fan manually.

It enables setting the fan speed to zero or one of the three defined limits (parameter "Controller Fan Limit 1 [%] (Controller Page Fan), Page 120]") by setting the object "Input, Fan Speed" to a value between 0 and 3 (see Table).

It is possible to set the fan speed to the actual value selected by the object „Input, Fan Speed“ by setting the Object „Input, Fan Mode“ to 1. If this object is set to 0, the Fan speed returns to the given controller value. When started, the fan runs for the time set in the parameter „Overwrite Timeout [minutes] (Temp. Controller Settings), Page 127“ before it returns to the given value from the controller.

If the object value of "Input, Fan Speed" is changed, the fan automatically starts (only if value is changed) for the set amount of time..

Value „Input, Fan Speed“	Object „Output, Fan Continuous [%]“	Object „Output, Fan ...		
		V1	V2	V3
0	0 %	0	0	0

1	Limit 1	1	0	0
2	Limit 2	0	1	0
3	Limit 3	0	0	1

2 vs. 4-Pipes Fancoil

2 Pipes

2-Pipe Fancoils only have one circuit for both heating and cooling. So there is one valve that controls the flow of the hot / cold media and one that switches between heating and cooling. This controller provides the objects corresponding to the selected type (e.g. PI-Controller) necessary to control a valve for the flow. The object "Output, Heating / Cooling" provides the information whether it is in heating or cooling mode.

4 Pipes

4-Pipe Fancoils have 2 circuits, one for the heating and one for the cooling media. So the Provides two separate controllers for heating and cooling. This controller provides the objects corresponding to the selected types (e.g. PI-Controller) necessary to control 2 valves for the flow, one for heating, one for cooling. The Object "Output, Heating / Cooling" provides the information whether it is in heating or cooling mode.

Switched vs. gap Fancoil Controller

If a switched room controller type is selected, it is necessary to switch between heating and cooling mode by changing the object "Input, Heating/Cooling". If a gap is selected, a temperature difference needs to be defined (parameter "Heating / Cooling Bandgap (Temp. Controller Settings), Page 126"), so that in the gap around the comfort setpoint all controllers are inactive.

⚠ If a fancoil is used for heating and cooling (especially if a 2-Pipe fancoil is used), and if the parameters are set accordingly, there is the possibility that e.g. the heating valve opens immediately after the cooling valve is closed, so that the hot heating fluid floods the cold system, which may be unwanted. To prevent this, use the parameter „Heating / Cooling Changeover Deadtime (Temp. Controller Settings), Page 126“.

5.1.8.4 Controller Output Objects

The prefixes such as:

- -Output, Heating/Cooling,
- -Output, Cooling 1st Stage,
- -Output, Cooling 2nd Stage,
- -Output, Cooling,
- -Output, Heating 1st Stage,
- -Output, Heating 2nd Stage,
- -Output, Heating,

correspond to the available controllers, which depend on the selected room temperature controller (Parameter "RTC Parameter, Page 119").

1st Level Switch

This one comes with the 3-point controller and is one of the two 1-bit outputs of this controller. The following figure shows the output values for a simple 3-point heating controller.

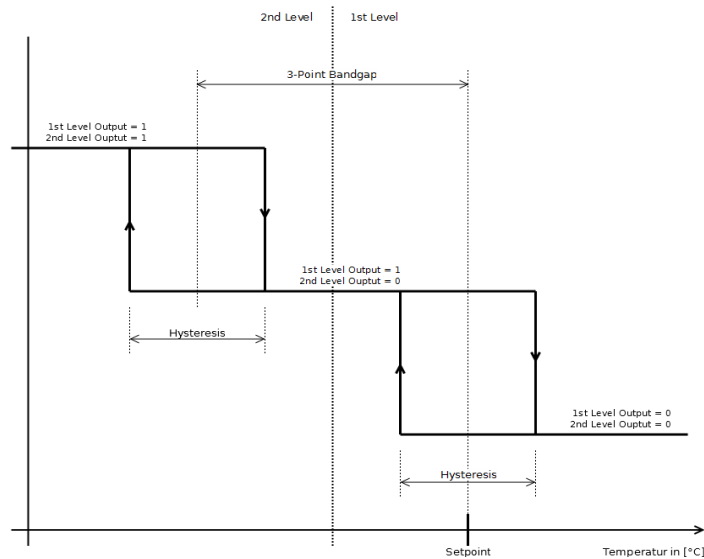
**2nd Level Switch**

See 1st level switch

PWM Output

This one comes with the PI-Controller with PWM. It is a 1-bit object with an PWM signal, its duty cycle is controlled corresponding to the PI-Controller output.

Steady Output

This one comes with the PI-Controller. It is a 1-byte object holding the control variable of the PI-Controller.



Allows to control a steady valve with a PI-Controller.

Steady Output Non-Zero

This one comes with the PI-Controller. It is a 1-bit object which only determines if the steady output is not zero.

!USE Can be used to indicate that the heater/cooler is active.

Switch

This one comes with the 2-point controller. It is a 1-bit value and outputs a simple switching signal, corresponding to the figure that shows the output values for a simple 2-point heating controller.

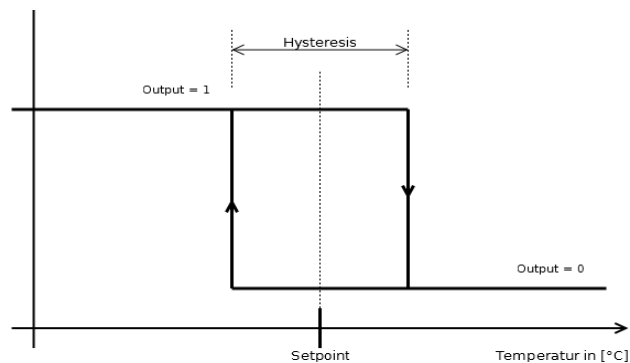

5.2 RTC Parameter

5.2.1 1st / 2nd Stage Bandgap (Temp. Controller Heating / Cooling)

See article "Heating vs. Cooling controller, Page 115".
The gap in °C between the first and the second controller stage.

e.g. A two-stage heating controller is selected, the actual setpoint to be regulated is 20 °C and the parameter "1st / 2nd Stage Bandgap" is set to 5 °C. The temperature falls below 20 °C. Now the first controller tries to heat. If the temperature should fall below 15 °C, the second controller will also start to heat.

Use If e.g. there are solar panels installed for heating, this heat source can be connected to the first stage. Only if the temperature keeps on falling, the electrical heater is activated via the second stage.

5.2.2 3-Point Bandgap (Temp. Controller Heating / Cooling)

See also section „3-Point Controller, Page 123“.
This sets the bandgap between the two 2-point controllers of the 3-point controller.
See figure.

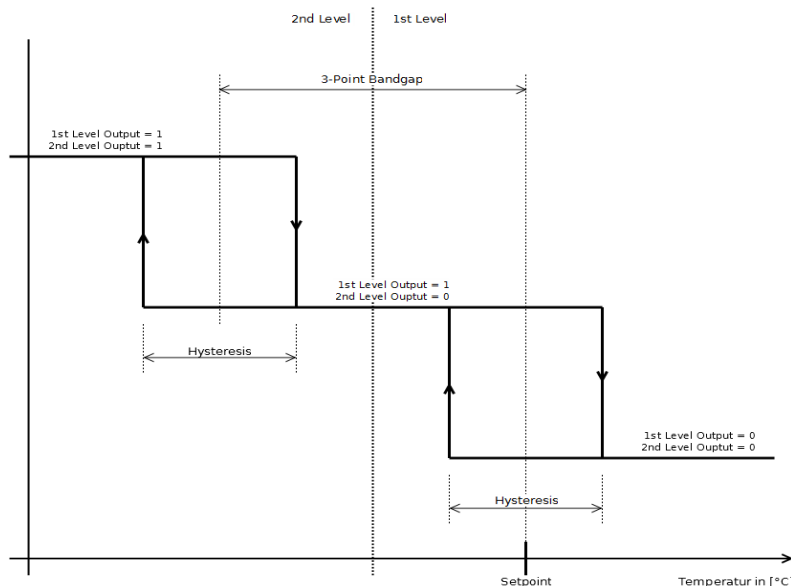

5.2.3 Absolute / Relative Setpoints (Temp. Controller Settings)

! This affects all parameters and objects that have an effect upon the different setpoints (Comfort setpoint is not affected because it is always absolute).
See also article "Setpoint handling, Page 112".

5.2.3.1 Relative

The settings for economy and stand-by setpoints are interpreted relative to the comfort setpoint. To get[1] the setpoint in cooling mode, the relative economy and stand-by setpoints are added to the comfort setpoint. Vice versa, in heating mode they are subtracted.

5.2.3.2 Absolute

The settings for economy and stand-by setpoints are interpreted as absolute values. If a controller with heating and cooling functionality is selected, the economy and stand-by setpoints are set for the heating part. For the cooling controllers, the setpoints are mirrored at the comfort setpoint.

e.g. Controller with heating and cooling and absolute setpoints. Comfort setpoint is 20 °C, economy setpoint is 15 °C, so that in heating mode the economy setpoint is 15 °C and in cooling it is 25 °C (20 °C + (20 °C - 15 °C)).

5.2.4 Comfort Setpoint Temperature (Absolute) (Temp. Controller Settings)

See also article "Setpoint handling, Page 112".

The comfort setpoint is always set as an absolute temperature. It is used as mirror point for the economy and stand-by setpoints.

5.2.5 Controller Fan Limit 1 [%] (Controller Page Fan)

See also article "Fancoil, Page 116".

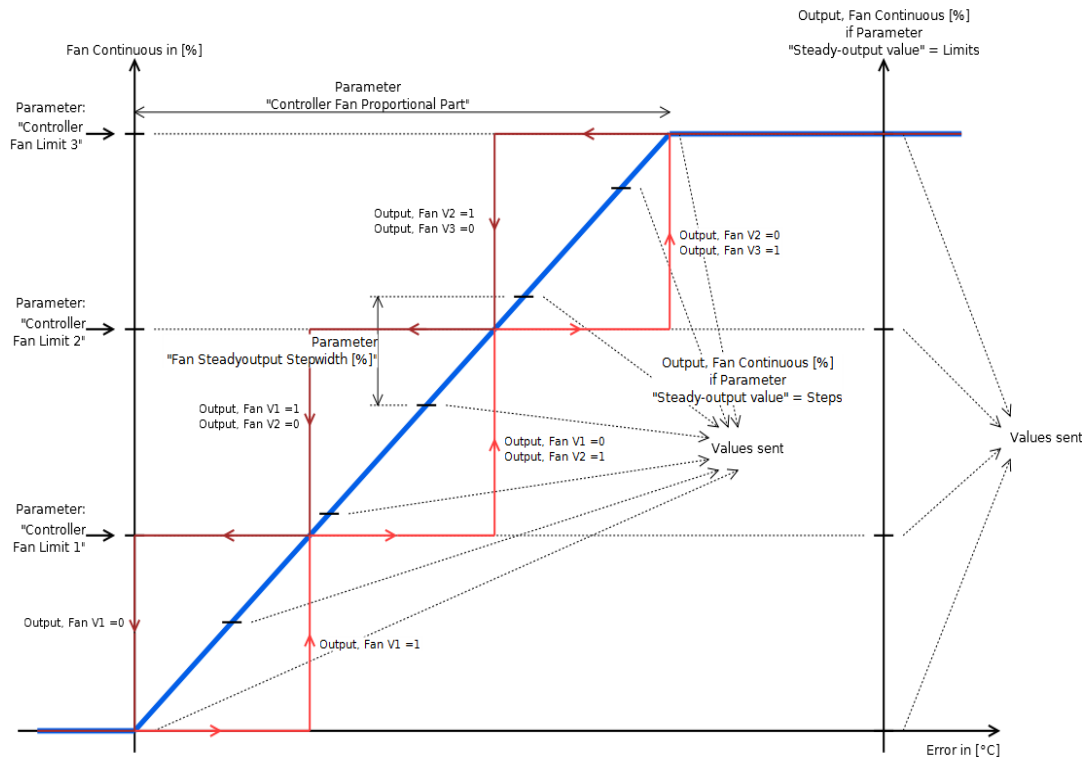

This is used as an input for the calculation of the "Output, Fan VX" 1-bit objects, with the internal steady value of the object "Output, Fan Continuous [%]" as reference value. This is formed according to the error (Setpoint - Temperature) and in dependency of the parameter "Controller Fan Proportional Part (Controller Page Fan) , Page 121". The formula for the steady value is $\{ \text{Error} * (100\% / \text{parameter "Controller Fan Proportional Part"}) \}$.

! At any time, only one object "Output, Fan VX" can be active. It is not possible that two or more are active at the same time.

If the continuous value exceeds a limit, the corresponding object "Output, Fan VX" is set to 1 if the continuous value falls below the limit the output object remains 1 until the continuous value falls below the next smaller limit or 0.

e.g. Parameter "Controller Fan Limit 1 [%]" is 30%. The steady value is 0, and so is the object "Output, Fan V1". If the steady value exceeds the 30 % threshold, the object is set to 1. If the steady value then falls below the 30 % threshold, the Fan V1 output remains at 1 until the value falls below 0.

If the parameter "Steady-output value" (Controller Page Fan) is set to limits, the "Controller Fan Limits X [%]" limits are also used as discretization steps for the object "Output, Fan Continuous [%]". See parameter "Steady-Output Value (Controller Page Fan) , Page 129".

These limits are also used for the objects "Input, Fan Mode [217], Page 136" and "Input, Fan Speed [218], Page 137".

5.2.6 Controller Fan Limit 2 [%] (Controller Page Fan)

See Parameter "Controller Fan Limit 1 [%] (Controller Page Fan), Page 120".

5.2.7 Controller Fan Limit 3 [%] (Controller Page Fan)

See Parameter "Controller Fan Limit 1 [%] (Controller Page Fan), Page 120".

5.2.8 Controller Fan Proportional Part (Controller Page Fan)

See also article "Fancoil, Page 116".

This sets the proportional part for the calculation of the object "Output, Fan Continuous [%]" (see equation). Together with the parameters "Controller Fan Limit X [%]", it serves as an input for the calculation for the output values of the objects "Output, Fan VX".

$$\text{Fan Continuous} = \text{Controller Fan Proportional Part} \cdot (\text{setpoint} - \text{Temperature})$$

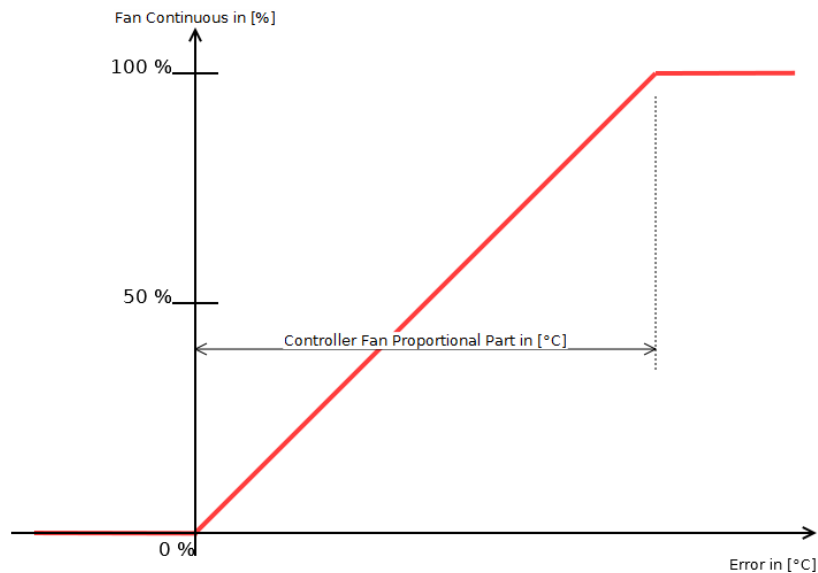

5.2.9 Controller Proportional Band Style (Temp. Controller Settings)

Affects all PI-controllers and PI-controllers with PWM. This setting describes how the "Proportional Part" of the PI-controller is interpreted (see figure , Page 122).

⚠ Fancoil is not affected.

5.2.9.1 Symmetric to Setpoint

👉 Use this if you only have a P-Controller (I=0)

This controller can be used with advantage in proper designed systems which preregulate the inlet temperature. Then this controller has better response times and lead to less distortion when changing the setpoints. It has disadvantages when using heating+cooling designs, because the bands may overlap.)

At an error of 0, the control variable is 50 %, and within the PB, the control variable is linear to the error and else 0 % or 100 %.
Equation for controller variable:

$$\text{Control variable} = K_p \cdot \text{Error}(t) + K_i \cdot \int_0^t \text{Error}(\tau) d\tau + 50\%$$

(for Kp and Ki see parameter „Controller Type (Temp. Controller Heating / Cooling), Page 123“)

5.2.9.2 Asymmetric to Setpoint

👉 Use this if in doubt.

If the error is 0, the control variable is also 0%, and if the error equals the parameter "Proportional Band", the control variable is 100%. Between these two points, it increases linearly.

Equation for controller variable:

$$\text{Control variable} = K_p \cdot \text{Error}(t) + K_i \cdot \int_0^t \text{Error}(\tau) d\tau$$

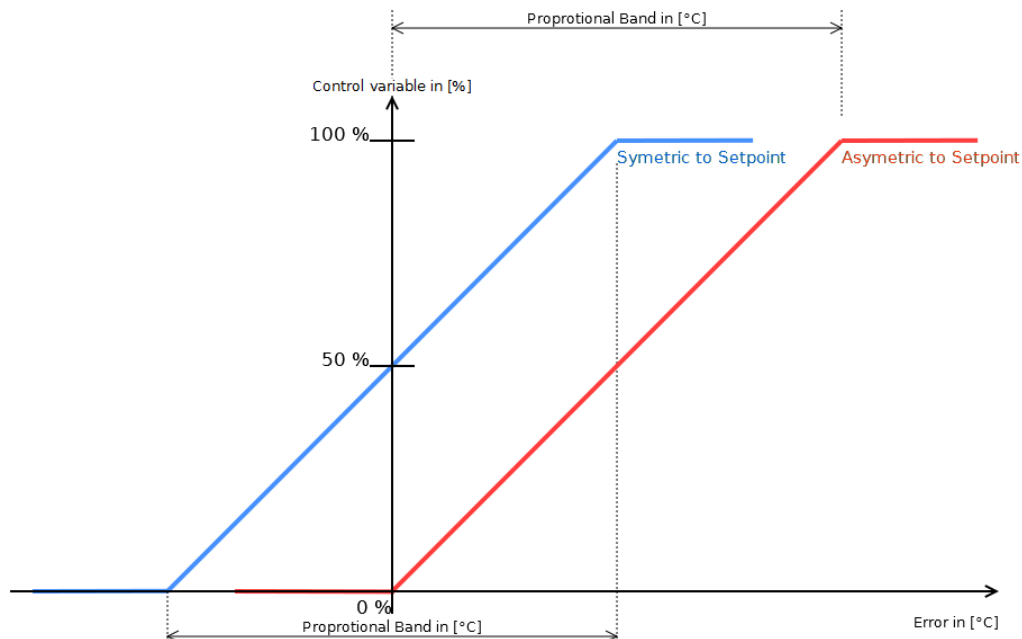

5.2.10 Controller Type (Temp. Controller Heating / Cooling)

See also article "Controller Output Objects, Page 117".

5.2.10.1 2-Point Controller

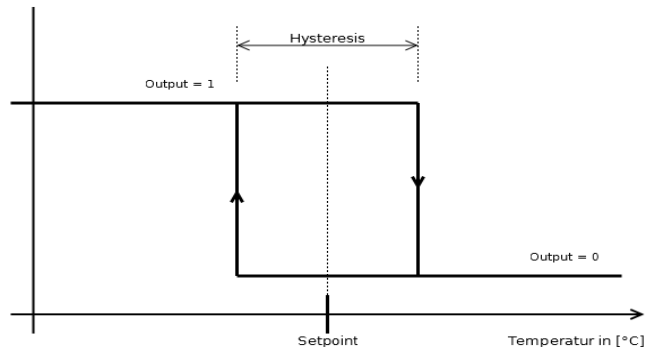

The figure shows a 2-point-controller heating. The hysteresis is set by the parameter "Hysteresis" (Temp. Controller Heating / Cooling) and the setpoint is at half the hysteresis value. For cooling mode, the figure can be viewed mirror-inverted at the setpoint.

5.2.10.2 3-Point Controller

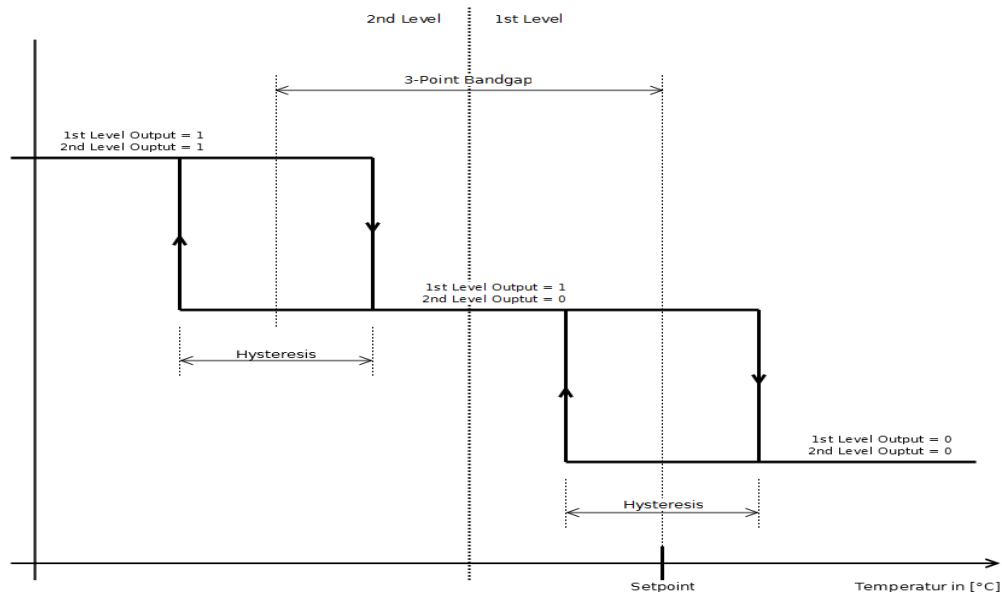

The figure shows a simple 3-point-controller heating. The setpoint in the 1st level is at half the hysteresis value. The hysteresis for both levels is the same and set by the parameter "Hysteresis" (Temp. Controller Heating / Cooling). The gap between the two levels is set by the 3-point bandgap. For cooling mode, the figure can be viewed mirror-inverted at the setpoint.

There are two 1-bit objects "... 1st Level Switch" and "... 2nd Level Switch". Both outputs correspond to the two levels in the figure.

5.2.10.3 PI-Controller

⚠ Affected by the parameter "Controller Proportional Band Style (Temp. Controller Settings), Page 122". The following description refers to the setting "Asymmetric to Setpoint".

For a more complete overview of how to set up a PI-controller see the article "PI-Controller Set Up, Page 111".

The equation for the control variable, which is a 1-byte object [0..100%], is shown in the box below. For the variable „proportional band“ see parameter "Proportional Band (Temp. Controller Heating / Cooling), Page 127", for the variable „Integration Time“ see parameter "Integration Time [minutes] (Temp. Controller Heating / Cooling), Page 126". The error variable is setpoint minus temperature.

$$\text{Control variable} = K_p \cdot \text{Error}(t) + K_i \cdot \int_0^t \text{Error}(\tau) d\tau$$

$$K_p = \frac{100}{\text{Proportional band}}$$

$$K_i = \frac{100}{\text{Proportional band} \cdot \text{Integration time} \cdot 60}$$

There is also a 1-bit object „... Steady Output non-zero“ output.

5.2.10.4 PI-Controller with PWM

! Affected by the parameter "Controller Proportional Band Style (Temp. Controller Settings), Page 122".

The internal function is the same here as in the PI-controller above. The parameter "PWM Cycletime [seconds] (*10) (Temp. Controller Heating / Cooling), Page 128" sets the time for the cycle and for the duty cycle according to the control variable (see Picture).

There is a steady 1-byte and a 1-bit PWM output.

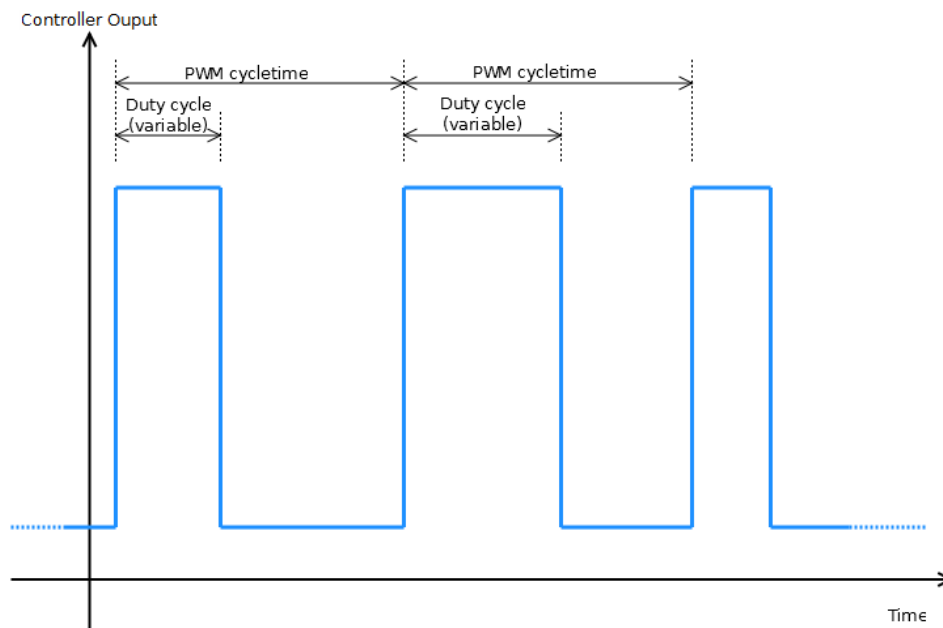

5.2.11 Economy Setpoint Temperature (Absolute) (Temp. Controller Settings)

See also article „Setpoint handling, Page 112“.

The economy setpoint for a heating or cooling controller is set as absolute temperature value.

5.2.12 Economy Setpoint Temperature (Heating, Absolute) (Temp. Controller Settings)

See also article „Setpoint handling, Page 112“.

The economy setpoint for a combined heating/cooling controller is set as absolute temperature value for the heating controller part. For the economy setpoint of the cooling controller part, the value set here is mirrored at the comfort setpoint.

(calculation: $\text{EconomySetpointCooling} = \text{ComfortSetpoint} + (\text{ComfortSetpoint} - \text{EconomySetpoint})$).

5.2.13 Economy Setpoint Temperature Decrease (Temp. Controller Settings)

See also article „Setpoint handling, Page 112“.

Economy setpoint for an Heating Controller, set as temperature difference to the Comfort Setpoint (relative).

5.2.14 Economy Setpoint Temperature Increase (Temp. Controller Settings)

See also article „Setpoint handling, Page 112“.

The economy setpoint for a cooling controller is set as temperature difference to the comfort setpoint (relative).

5.2.15 Economy Setpoint Temperature De- / Increase (Temp. Controller Settings)

See also article „Setpoint handling, Page 112“.

The economy setpoint for a heating / cooling controller is set as temperature difference to the comfort setpoint (relative).

5.2.16 External Temperature Weight [%] (Temp. Controller Settings)

Defines the weight of the external temperature (object "Input, Actual Temperature") in relation to the temperature measured by the sensor that is directly connected to the device.

The temperature. For the calculation see equation..

$$\text{Temperature} = \text{ExternalTemperature} [^{\circ}\text{C}] \cdot \text{ExternalTemperature weight} [\%] + \text{InternalTemperature} [^{\circ}\text{C}] \cdot (100 \% - \text{ExternalTemperature weight} [\%])$$

The calculated temperature is displayed at the object "Output, actual Temperature" and is used as a reference for all operations of all controllers and is the displayed actual temperature if used.

 No sensor directly connected to the device, only the temperature from the object "Input, External Temperature" shall be used. Set the parameter "External Temperature weight" to 100. With this setting, the external temperature will be used and the other temperature input will be ignored.

 The parameter "External Temperature weight" is set to 50, the external temperature reading is 21 °C and the internal is 22 °C. With this setting, the internal temperature will be calculated to 21.5 °C and also sent to the object "Output, Actual Temperature".

 If no sensor is directly connected to the device, the external temperature weight must be 100%.

5.2.17 Fan Lag-Time [sec] (Controller Page Fan)

See also article "Fancoil, Page 116".

The timer starts after the internal Continuous Fan Value[3] returns to zero. Until the time set with this parameter is elapsed, the object "Output, Fan V1" remains on 1 and the object "Output, Fan continuous [%]" remains on the value set at parameter "Controller Fan Limit 1 [%]" (Controller Page Fan), although both should already be zero.

 If the valve for the heating/cooling fluid is closed, there is still some fluid left in the radiator. With this setting it is possible to use this rest more efficiently.

5.2.18 Fan Lead-Time [sec] (Controller Page Fan)

The timer starts after the Continuous Fan Value[4] becomes other than zero. The objects "Output, Fan VX" and "Output, Fan Continuous [%]" remain on 0 until the time has elapsed, although both should already have values.

 When the valve for the heating/cooling fluid is opened, it takes some time until the fluid arrives at the radiator. With this setting it is possible to save the energy for the fan in that time

5.2.19 Fan Steadyoutput Stepwidth [%] (Controller Page Fan)

Defines how big the change of the object "Output, Fan Continues [%]" has to be before it is sent to the bus.

5.2.20 Heating / Cooling Bandgap (Temp. Controller Settings)

More also article "Setpoint handling, Page 112".

Defines the gap between heating and cooling mode in °C.

 If the temperature rises above the comfort setpoint minus heating / cooling gap, half the heating controller will be switched off. If the temperature then rises above the comfort setpoint plus heating / cooling gap, half the cooling controller will be switched on, using comfort setpoint plus heating / cooling gap half as setpoint to regulate upon. In the area between these two points, both controllers are inactive.

5.2.21 Heating / Cooling Changeover Deadtime (Temp. Controller Settings)

Time until the switch between heating and cooling controller occurs.

 After the temperature has risen above the comfort setpoint, the heating controller will be switched off, and the timer starts. When the timer has elapsed, the cooling controller starts if the temperature is still above the comfort setpoint.

 Can prevent fluctuations of fast switching between heating and cooling mode.

5.2.22 Hysteresis (Temp. Controller Heating / Cooling)

See also parameter "Controller Type (Temp. Controller Heating / Cooling), Page 123".
Defines the hysteresis in °C for the 2-point and the 3-point controller.

5.2.23 Integration Time [minutes] (Temp. Controller Heating / Cooling)

See also parameter "Controller Type (Temp. Controller Heating / Cooling), Page 123" and article "PI-Controller Set Up, Page 111".

Defines the integration time for the PI and PI-controller with PWM.

 If this value is set to 0, the PI-controller becomes an simple P-controller.

 There is always the possibility that a PI-controller oscillates if the wrong or poor parameters are used.

In general, a shorter integration time means a quicker adjustment to the setpoint but a higher risk of continual oscillation. Vice versa, a longer integration time means a slower adjustment to the setpoint but an lower risk of continual oscillation.

5.2.24 Minimum / Maximum Gap [%] (Temp. Controller Heating / Cooling)

If the control variable rises above (100% - Minimum/maximum gap) or below the minimum / maximum gap, the control variable is directly set to 100% or 0%, see figure.

 Some steady valves have problems in there marginal areas. With this, it is possible to "jump" over these areas.

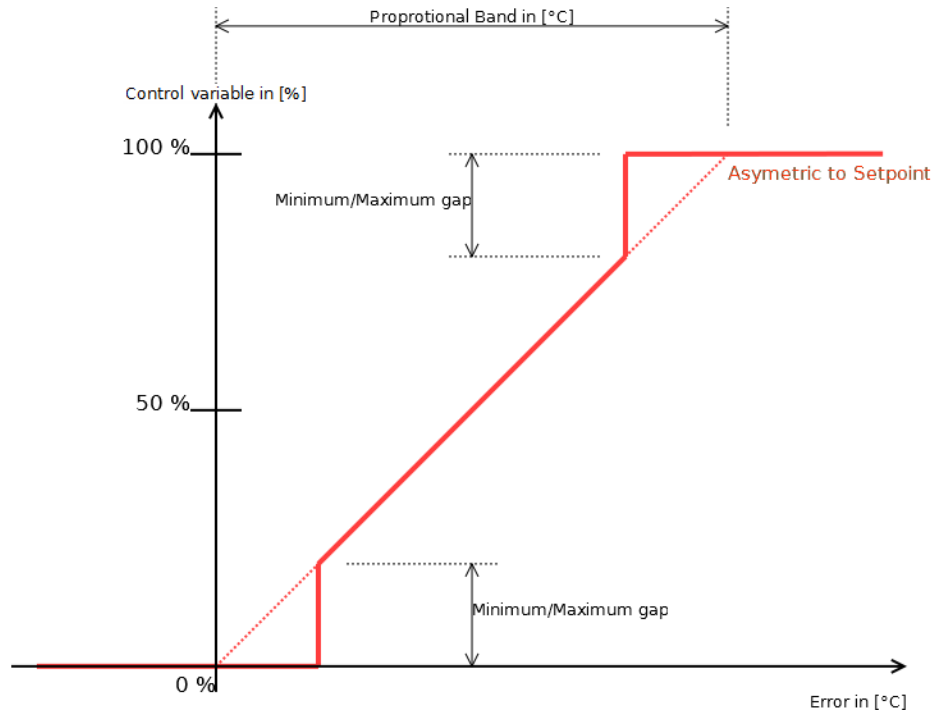

5.2.25 Output Send On Change Off (Temp. Controller Heating / Cooling)

This affects the corresponding Steady PI-Controller Outputs and determines after which change the value is sent again.

5.2.26 Outputs Sending Cycle [minutes] (Temp. Controller Settings)

This affects the output of the object "Output, actual Temperature" and determines, in which time interval the temperature is sent. If 0, the value will not be sent cyclically.

5.2.27 Overwrite Timeout [minutes] (Temp. Controller Settings)

This determines how long it takes to return to the last mode before the object "Input, Set Comfort Mode (overwrite)" was used and how long it takes to return to the default comfort setpoint after a setpoint adjustment via object "Input, Setpoint Adjust" was carried out. This timeout is also used for the fancoil object "Input, Fan Mode" and "Input, Fan Speed". See the object descriptions for further information.

 If the controller is in stand-by mode and the comfort overwrite mode is activated via the object "Input, Set Comfort Mode (overwrite)", the controller changes into comfort mode and starts to regulate the corresponding comfort setpoint. The timer with the set timeout starts. If the mode is not changed otherwise (e.g. by higher prioritized mode selectors like object "Input, Set Protection Mode") and the timer elapses, the controller returns to stand-by mode.

5.2.28 Proportional Band (Temp. Controller Heating / Cooling)

See also parameter "Controller Type (Temp. Controller Heating / Cooling), Page 123" and article "PI-Controller Set Up, Page 111".

Defines the proportional band for the PI and PI-controller with PWM.

 There is always the possibility that a PI-controller oscillates if the wrong or poor parameters are used.

In general, a smaller proportional band means a quicker adjustment to the setpoint, but more fluctuations. Vice versa, a bigger proportional band means a slower adjustment to the setpoint and smaller or no fluctuations.

5.2.29 Protection Setpoint Temperature High (Absolute) [°C] (Temp. Controller Settings)

See also article "Setpoint handling, Page 112".

Protection setpoint for cooling controller. This one is always set absolute in °C. If the controller is in protection mode, there is no setpoint output on the object "Output, Setpoint".

5.2.30 Protection Setpoint Temperature Low (Absolute) [°C] (Temp. Controller Settings)

See also article "Setpoint handling, Page 112".

Protection setpoint for heating controller. This one is always set absolute in °C. If the controller is in protection mode, there is no setpoint output on the object "Output, Setpoint".

5.2.31 PWM Cycletime [seconds] (*10) (Temp. Controller Heating / Cooling)

See also parameter "Controller Type (Temp. Controller Heating / Cooling), Page 123" and article "PI-Controller Set Up, Page 111".

⚠ A low PWM cycle time also means more switching cycles for the valves or relays. Not all are designed for that.

Defines how long one PWM cycle takes. See figure.

In general, a shorter cycle time means a faster response and less temperature fluctuation but also more stress for the valve or relay. Vice versa, a longer cycle time means a slower response and more temperature fluctuations, but also less stress for the valve or relay. This strongly depends on the used heating and/or cooling system.

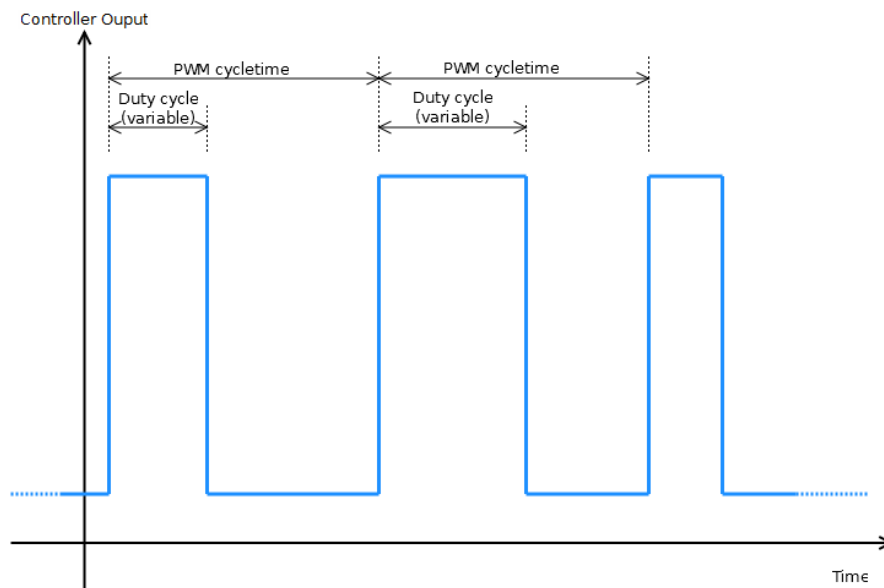

5.2.32 Room Temperature Controller (Main)

Determines the general used controller structure, e.g. how many unique controllers there are, if fancoil is available, if it is a one- or two-stage controller, heating and/or cooling, etc. The major differences of the available entries are described in the article "Room Temperature Controllers, Page 114".

5.2.33 Setpoint Adjustment Range (Temp. Controller Settings)

The comfort setpoint can be adjusted temporally in the range set by this parameter. The setpoint changes at least for the time set in parameter "Overwrite Timeout [minutes] (Temp. Controller Settings), Page 127" or until the mode is changed otherwise (e.g. to stand-by).

The object "Input, Setpoint Adjust" is a 1-byte object which is interpreted according to the set range as follows:

Selection "+0 °C .. +3 °C" and "+0 °C .. +5 °C"

as 1 byte unsigned in which 0 corresponds to +0 °C and 255 to +3 °C or +5 °C.

Selection "-3 °C .. +3 °C" and "-5 °C .. +5 °C"

as 1 byte signed in which 0 corresponds to +0 °C, 127 to +3 °C or +5 °C and -128 to -3 °C or -5 °C.

Selection "-3 °C .. +0 °C" and "-5 °C .. +0 °C"

as 1 byte unsigned in which 0 corresponds to +0 °C and 255 to -3 °C or -5 °C.

5.2.34 Stand-by Setpoint Temperature (Absolute) (Temp. Controller Settings)

See also article "Setpoint handling, Page 112".

Stand-by setpoint for a heating or cooling controller, set as absolute temperature value.

5.2.35 Stand-By Setpoint Temperature (Heating, Absolute) (Temp. Controller Settings)

See also article "Setpoint handling, Page 112".

Stand-by setpoint for a combined heating/cooling controller, set as absolute temperature value for the heating controller part. For the stand-by setpoint of the cooling controller part, the value set here is mirrored at the comfort setpoint .
(calculation: $\text{Stand-bySetpointCooling} = \text{ComfortSetpoint} + (\text{ComfortSetpoint} - \text{Stand-bySetpoint})$).

5.2.36 Stand-by Setpoint Temperature De- / Increase (Temp. Controller Settings)

See also article "Setpoint handling, Page 112".

Economy setpoint for a heating/cooling controller, set as temperature difference to the comfort setpoint (relative).

5.2.37 Stand-By Setpoint Temperature Decrease (Temp. Controller Settings)

See also article "Setpoint handling, Page 112".

Stand-by setpoint for heating controller, set as temperature difference to the comfort setpoint (relative).

5.2.38 Standby Setpoint Temperature Increase (Temp. Controller Settings)

See also article "Setpoint handling, Page 112".

Stand-by setpoint for cooling controller, set as temperature difference to the comfort setpoint (relative).

5.2.39 Steady-Output Value (Controller Page Fan)

Determines in which intervals the output on the object "Output, Fan Continuous [%]" is sent. See figure below.

5.2.39.1 Steps

If this is selected, the parameter option "Fan Steadyoutput Stepwidth [%]" (Controller Page Fan) is enabled. Now this new parameter allows to set a stepwidth, which defines how much the object "Output, Fan Continuous [%]" has to change until it is sent again.

5.2.39.2 Limits

The output is only sent if the value passes the corresponding limit of the limits set by the parameters "Controller Fan Limit X [%]" (Controller Page Fan).

 Fan limit 1 is 25 %. If the value exceeds this limit, the value 25 % is sent to the object "Output, Fan Continuous [%]". If the value falls below this limit, it remains to be 25 %. If the value reaches 0% (in other cases the next lower limit), the object is updated to 0%.

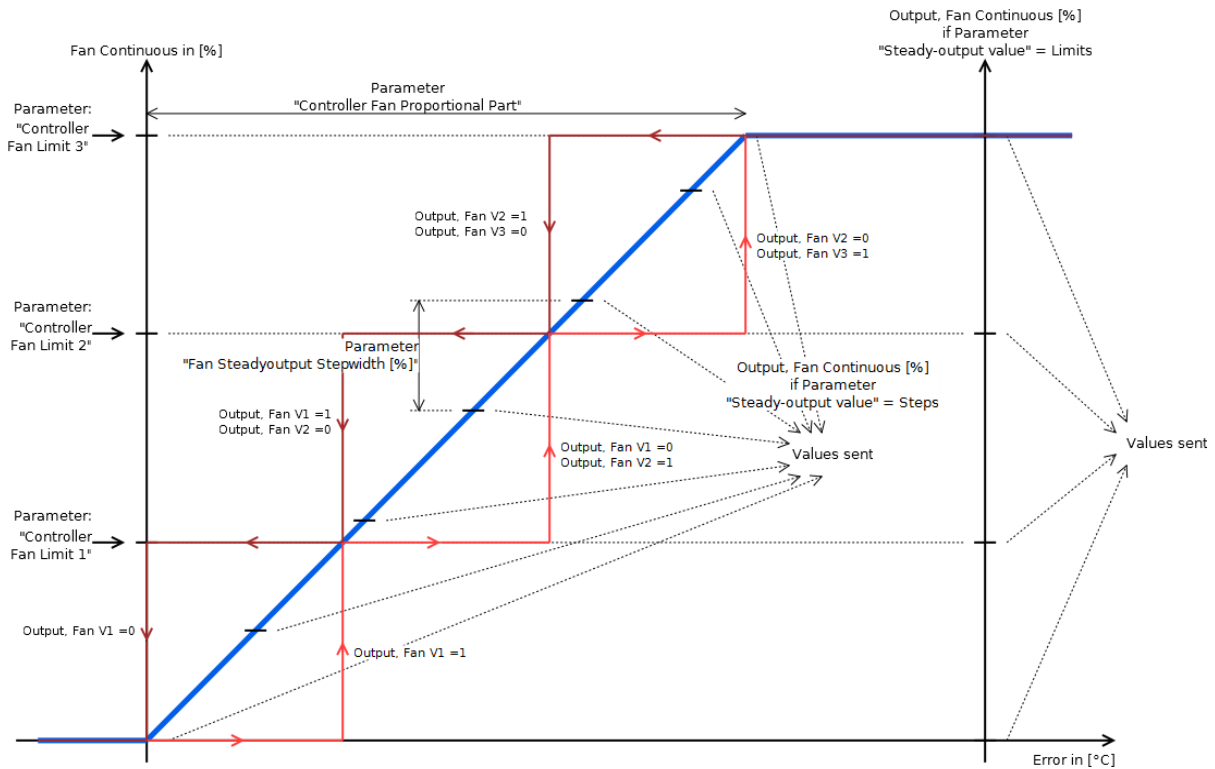

5.2.40 Temperature Offset [* 0,1 °C] (Temp. Controller Settings)

The value set here, multiplied with 0,1 °C, will be added to the temperature measured by the sensor that is directly connected to the Touch-IT (doesn't affect the temperature via object "Input, external Temperature"). The so calculated temperature is then combined with the temperature from the object "Input, external Temperature" (according to the factor set by the parameter "External Temperature Weight [%] (Temp. Controller Settings), Page 125"). It will then be used for internal controller calculation and also for the output on object "Output, actual Temperature".

5.2.41 Temperature Send Cycle [minutes] (Temp. Controller Settings)

This affects the output of the object "Output, actual Temperature". It determines in which interval the value is sent. If it is set to 0, the value will not be sent cyclically.

5.2.42 Temperature Send on Change of (Temp. Controller Settings)

This affects the output of the object "Output, actual Temperature" and determines how much the temperature has to change until the temperature is sent again.

5.3 RTC Communication Objects

5.3.1 Output, Actual Temperature [196]

The actual temperature is sent to this object. This temperature value is calculated as described in the parameter "External Temperature Weight [%] (Temp. Controller Settings), Page 125".

It is possible to send this value periodically or, if it has changed by a certain value, parameterized by the parameter "Temperature Send on Change of (Temp. Controller Settings), Page 130" and "Temperature Send Cycle [minutes] (Temp. Controller Settings), Page 130".

5.3.2 Input, External Temperature [197]

Allows to input an external temperature value from an external sensor that is connected to the bus. The weight against the internal temperature that is measured by the sensor directly attached to the device is set by the parameter "External Temperature Weight [%] (Temp. Controller Settings), Page 125".

5.3.3 Input, HVAC-Mode [198]

Allows to switch between the different modes, e.g. comfort, stand-by, ... mode in order to activate the different setpoints, see table.

There is also the possibility to set this mode via 1-bit objects, e.g. the object "Input, Set Comfort Mode". These different possibilities are prioritized. The object "Input, HVAC-Mode" has the lowest priority, which means it is overwritten if one of the 1-bit objects is used (set to 1).

Input, HVAC-Mode Value	
0	Auto Mode (Hands the mode-control over to a HVAC-profile-display-widget, defaults to Standby Mode if no internal profile-widget is defined)
1	Comfort Mode
2	Standby Mode
3	Economy Mode
4	Protection Mode
5...255	Not used

5.3.4 Input, Setpoint Comfort Mode (Absolute) [199]

Allows to set the Comfort setpoint for an Heating or Cooling Controller set as absolute temperature Value. The Comfort setpoint is always absolute and serves as reference for the other setpoints.

 If comfort setpoint is 20 °C, standby setpoint is 15 °C, an Room Temperature Controller with heating and cooling and also absolute setpoints are used. This means that the standby setpoint for cooling is calculated to 25 °C (20°C + (20 °C - 15 °C)).

5.3.5 Input, Setpoint Economy Mode Decrease [200]

Allows to set the economy setpoint for a heating controller, set as temperature difference to the comfort setpoint (relative).

5.3.6 Input, Setpoint Standby Mode Decrease [201]

Allows to set the stand-by setpoint for a heating controller, set as temperature difference to the comfort setpoint (relative).

5.3.7 Input, Set Protection Mode [202]

Priority: 5 (low value low Priority)

See Object "Input, Set Comfort Mode".

5.3.8 Input, Set Comfort Mode (Overwrite) [203]

Priority: 4 (low value, low priority)

See object "Input, Set Comfort Mode [204], Page 132" except the setting to comfort-mode is only temporary as defined by parameter „Overwrite Timeout [minutes] (Temp. Controller Settings), Page 127“.

5.3.9 Input, Set Comfort Mode [204]

Priority: 3 (low value, low priority)

If this 1-bit object is set to 1, the corresponding setpoint is activated and remains active until the object is set to 0 or another object like "Input, Set OFF Mode" with a higher priority is set to 1.

5.3.10 Input, Set Economy Mode [205]

Priority: 2 (low value low Priority)

See Object "Input, Set Comfort Mode [204], Page 132".

5.3.11 Input, Set OFF Mode [206]

Priority: 6 (low value, low priority)

See object "Input, Set Comfort Mode [204], Page 132".

5.3.12 Input, Setpoint Adjust [207]

See also parameter "Setpoint Adjustment Range (Temp. Controller Settings), Page 128“.

If and only if the controller is in comfort mode, it is possible to adjust the current setpoint within the range set in the parameter "Setpoint Adjustment Range (Temp. Controller Settings), Page 128". These changes remain active for the time set in the parameter "Overwrite Timeout [minutes] (Temp. Controller Settings), Page 127". After that time, the setpoint returns to the value it was set to before the adjustment.

 The comfort setpoint is 20 °C and the room controller is in comfort mode. The parameter "Setpoint adjustment range" is set to "-5 °C .. +5 °C" and the parameter "Overwrite timeout [minutes]" is 30.

If the object "Input, Setpoint Adjust" is set to 64, the used setpoint is 22.5 °C (20 °C + (5°C * 64/127), this setpoint is then valid for 30 minutes.

5.3.13 Output, Setpoint [208]

The actual setpoint is sent to this object if the controller is not in protection mode.

 Heating/cooling room controller type sends the actual setpoint corresponding to the modes heating/cooling and comfort, stand-by and economy.

 Room controller in comfort mode and setpoint adjustment are used. If the value at the object "Input, Setpoint Adjust" is changed, the value on the object "Output, Setpoint" will be updated.

5.3.14 Input, Setpoint Economy Mode (absolute) [200]

Allows to set the economy setpoint for a heating or cooling controller, set as absolute temperature value.

5.3.15 Input, Setpoint Economy Mode (heating, absolute) [200]

Allows to set the economy setpoint for a combined heating/cooling controller, set as absolute temperature value for the heating controller part. For the economy setpoint of the cooling controller part, the value set here is mirrored at the comfort setpoint.

(calculation: $\text{EconomySetpointCooling} = \text{ComfortSetpoint} + (\text{ComfortSetpoint} - \text{EconomySetpoint})$).

5.3.16 Input, Setpoint Economy Mode De- / Increase [200]

Allows to set the economy setpoint for a heating/cooling controller, set as temperature difference to the comfort setpoint (relative).

5.3.17 Input, Setpoint Economy Mode Increase [200]

Allows to set the economy setpoint for a cooling controller, set as temperature difference to the comfort setpoint (relative).

5.3.18 Input, Setpoint Standby Mode (Absolute) [201]

Allows to set the stand-by setpoint for a heating or cooling controller, set as absolute temperature value.

5.3.19 Input, Setpoint Standby Mode (Heating, Absolute) [201]

Allows to set the stand-by setpoint for a combined heating/cooling controller, set as absolute temperature value for the heating controller part. For the stand-by setpoint of the cooling controller part, the value set here is mirrored at the comfort setpoint. (calculation: $\text{StandbySetpointCooling} = \text{ComfortSetpoint} + (\text{ComfortSetpoint} - \text{StandbySetpoint})$)

5.3.20 Input, Setpoint Standby Mode De- / Increase [201]

Allows to set the economy setpoint for a heating/cooling controller, set as temperature difference to the comfort setpoint (relative)

5.3.21 Input, Setpoint Standby Mode Increase [201]

Allows to set the stand-by setpoint for a cooling controller, set as temperature difference to the comfort setpoint (relative).

5.3.22 Input, Heating / Cooling [219]

If a switched room controller type is selected, it is possible to set the modes heating or cooling via this object (also available if a fancoil room controller type is selected)..

Input, heating/cooling Value	
1	Heating
0	Cooling

5.3.23 Output, Heating / Cooling [219]

If a room controller type with heating / cooling and a gap is used, this output indicates if the controller is in heating or in cooling mode.)

Input, Heating/Cooling Value	
1	Heating
0	Cooling

5.3.24 Output, Heating / Cooling, 1st Level Switch [210 / 214]

See article "Controller Output Objects, Page 117".

5.3.25 Output, Heating / Cooling, 2nd Level Switch [212 / 216]

See article "Controller Output Objects, Page 117".

5.3.26 Output, Heating / Cooling, PWM Output [210 / 214]

See article "Controller Output Objects, Page 117".

5.3.27 Output, Heating / Cooling, Steady Output [209 / 213]

See article "Controller Output Objects, Page 117".

5.3.28 Output, Heating / Cooling, Steady Output non-zero [210 / 214]

See article "Controller Output Objects, Page 117".

5.3.29 Output, Heating / Cooling, Switch [210 / 214]

See article "Controller Output Objects, Page 117".

5.3.30 Output, Cooling 1st Stage, 1st Level Switch [214]

See article "Controller Output Objects, Page 117".

5.3.31 Output, Cooling 1st Stage, 2nd Level Switch [216]

See article "Controller Output Objects, Page 117".

5.3.32 Output, Cooling 1st Stage, PWM Output [214]

See article "Controller Output Objects, Page 117".

5.3.33 Output, Cooling 1st Stage, Steady Output [213]

See article "Controller Output Objects, Page 117".

5.3.34 Output, Cooling 1st Stage, Steady Output Non-Zero [214]

See article "Controller Output Objects, Page 117".

5.3.35 Output, Cooling 1st Stage, Switch [214]

See article "Controller Output Objects, Page 117".

5.3.36 Output, Cooling 2nd Stage, 1st Level Switch [214]

See article "Controller Output Objects, Page 117".

5.3.37 Output, Cooling 2nd Stage, 2nd Level Switch [216]

See article "Controller Output Objects, Page 117".

5.3.38 Output, Cooling 2nd Stage, PWM Output [216]

See article "Controller Output Objects, Page 117".

5.3.39 Output, Cooling 2nd Stage, Steady Output [215]

See article "Controller Output Objects, Page 117".

5.3.40 Output, Cooling 2nd Stage, Steady Output non-zero [216]

See article "Controller Output Objects, Page 117".

5.3.41 Output, Cooling 2nd Stage, Switch [216]

See article "Controller Output Objects, Page 117".

5.3.42 Output, Cooling, 1st Level Switch [213]

See article "Controller Output Objects, Page 117".

5.3.43 Output, Cooling, 2nd Level Switch [214]

See article "Controller Output Objects, Page 117".

5.3.44 Output, Cooling, PWM Output [214]

See article "Controller Output Objects, Page 117".

5.3.45 Output, Cooling, Steady Output [216]

See article "Controller Output Objects, Page 117".

5.3.46 Output, Cooling, Steady Output Non-Zero [214]

See article "Controller Output Objects, Page 117".

5.3.47 Output, Cooling, Switch [214]

See article "Controller Output Objects, Page 117".

5.3.48 Output, Heating 1st Stage, 1st Level Switch [209]

See article "Controller Output Objects, Page 117".

5.3.49 Output, Heating 1st Stage, 2nd Level Switch [210]

See article "Controller Output Objects, Page 117".



5.3.50 Output, Heating 1st Stage, PWM Output [210]

See article "Controller Output Objects, Page 117".

5.3.51 Output, Heating 1st Stage, Steady Output non-zero [210]

See article "Controller Output Objects, Page 117".

5.3.52 Output, Heating 1st Stage, Steady Output [209]

See article "Controller Output Objects, Page 117".

5.3.53 Output, Heating 1st Stage, Switch [210]

See article "Controller Output Objects, Page 117".

5.3.54 Output, Heating 2nd Stage, 1st Level Switch [211]

See article "Controller Output Objects, Page 117".

5.3.55 Output, Heating 2nd Stage, 2nd Level Switch [212]

See article "Controller Output Objects, Page 117".

5.3.56 Output, Heating 2nd Stage, PWM Output [212]

See article "Controller Output Objects, Page 117".

5.3.57 Output, Heating 2nd Stage, Steady Output [211]

See article "Controller Output Objects, Page 117".

5.3.58 Output, Heating 2nd Stage, Steady Output Non-Zero [212]

See article "Controller Output Objects, Page 117".

5.3.59 Output, Heating 2nd Stage, Switch [212]

See article "Controller Output Objects, Page 117".

5.3.60 Output, Heating, 1st Level Switch [209]

See article "Controller Output Objects, Page 117".

5.3.61 Output, Heating, 2nd Level Switch [210]

See article "Controller Output Objects, Page 117".

5.3.62 Output, Heating, PWM Output [210]

See article "Controller Output Objects, Page 117".

5.3.63 Output, Heating, Steady Output [209]

See article "Controller Output Objects, Page 117".

5.3.64 Output, Heating, Steady Output Non-Zero [210]

See article "Controller Output Objects, Page 117".

5.3.65 Output, Heating, Switch [210]

See article "Controller Output Objects, Page 117".

5.3.66 Output, Fan Continuous [%] [211]

This is a steady 1-byte output for the fan of a fancoil room controller type. The style of the output is set by different parameters such as "Steady-Output Value (Controller Page Fan), Page 129", "Controller Fan Limit 1 [%] (Controller Page Fan), Page 120" and "Fan Steadyoutput Stepwidth [%] (Controller Page Fan), Page 126".

It is also possible to use the three 1-bit objects "Output, Fan VX" to control the fan.



5.3.67 Output, Fan V1 [212]

See also article "Fancoil, Page 116".

If the corresponding limit, set by the parameter "Controller Fan Limit 1 [%] (Controller Page Fan), Page 120", is exceeded by the fan continuous value, this object is set to 1. It remains to be 1 until the value falls below the next lower limit or becomes 0. See figure.

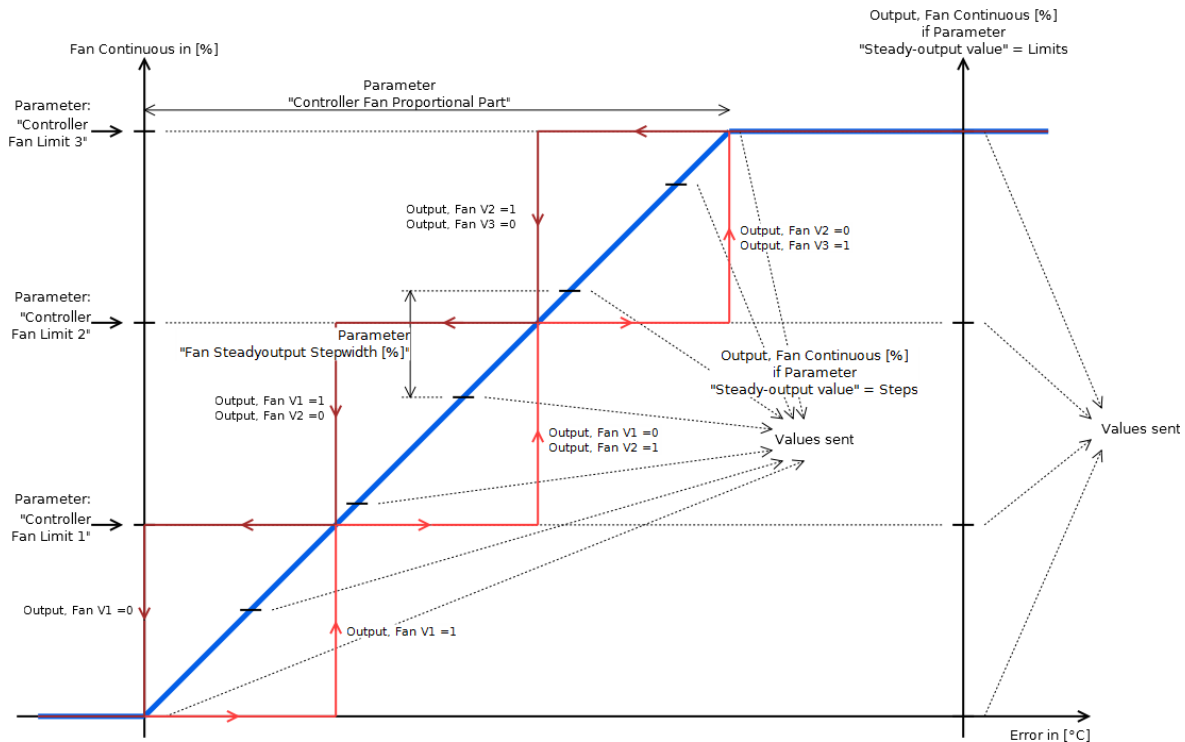

5.3.68 Output, Fan V2 [215]

See "Output, Fan V1 [212], Page 136"

5.3.69 Output, Fan V3 [216]

See "Output, Fan V1 [212], Page 136"

5.3.70 Input, Fan Mode [217]

If set to 1, the objects "Output, Fan Continuous [%]" and "Output, Fan VX" are set to the values corresponding to the speed set at the object "Input, Fan Speed". This value remains active for the time set in the parameter "Overwrite Timeout [minutes] (Temp. Controller Settings), Page 127". Afterwards, it returns to the given value of the controller.

If set to 0, the fan outputs are set as given by the controller.

5.3.71 Input, Fan Speed [218]

Allows to define the value which is then available to set[1] via the object "Input, Fan Mode" as shown in the table. If this value is changed, the corresponding outputs of the objects "Output, Fan VX" and "Output, Fan Continuous [%]" are immediately set to the corresponding value. As usual, these values only remain active for the time set in the parameter "Overwrite Timeout [minutes] (Temp. Controller Settings), Page 127".

 The new values are output immediately when they are changed. This makes it possible to see if the desired setting is OK without having to change the object "Input, Fan Mode" after every change..

Value „Input, Fan Speed“	Object „Output, Fan Continuous [%]“	Object „Output, Fan ...		
		V1“	V2“	V3“
0	0 %	0	0	0
1	Parameter „Controller Fan Limit 1 [%]“ (Controller Page Fan)	1	0	0
2	Parameter „Controller Fan Limit 1 [%]“(Controller Page Fan)	0	1	0
3	Parameter „Controller Fan Limit 1 [%]“(Controller Page Fan)	0	0	1

5.3.72 Output, Status1 [220]

Provides general room controller status information.

This is inspired by the DPT_HVACStatus, only the fourth bit differs, which is not the dew point, see table.

Bit	Attributes	Description	Encoding
b0	Comfort Mode	Indicates if Comfort Mode is active or not	1=active 0=inactive
b1	Standby Mode	Indicates if Standby Mode is active or not	1=active 0=inactive
b2	Economy Mode	Indicates if Economy Mode is active or not	1=active 0=inactive
b3	Frost/Heat protection Mode	Indicates if Protection Modes is active (only Mode)	1=active 0=inactive
b4	OFF Mode	Indicates if OFF Mode is active or not	1=active 0=inactive
b5	Heating/Cooling	Indicates if controller is heating or cooling	0=cooling 1=heating
b6	Controller Status	Indicates if one Heating or Cooling output is not equal 0	1=active 0=inactive
b7	Frost alarm	Indicates if in Protection mode and controller is active (controller output not equal zero)	1=active 0=inactive

5.3.73 "Output, Status2" [221]

Provides more detailed information of the Room Controller status.

Bit	Attributes	Description	Encoding
b0	Controller Heating 1st Stage	Indicates if this Controller is active ore not	1=active 0=inactive
b1	Controller Heating 2nd Stage	Indicates if this Controller is active ore not	1=active 0=inactive
b2	Controller Cooling 1st Stage	Indicates if this Controller is active ore not	1=active 0=inactive
b3	Controller Cooling 2nd Stage	Indicates if this Controller is active ore not	1=active 0=inactive
b4 b5	Fancoil limits	Shows the actual status of the Fancoil limits	BIN DEC Description 0b00 = 0 = Off 0b01 = 1 = Limit 1 exceeded 0b10 = 2 = Limit 2 exceeded 0b11 = 3 = Limit 3 exceeded
b6 .. b15	Not used	Not used	always 0

6 Logic

The logical functions are developed in the scripting language LUA. The available implemented functions will be described more on the following pages. 31 communication objects are reserved for logical functions. As the necessary object types can vary depending on the requirements, there are 6 different object schemas available.

6.1 ETS

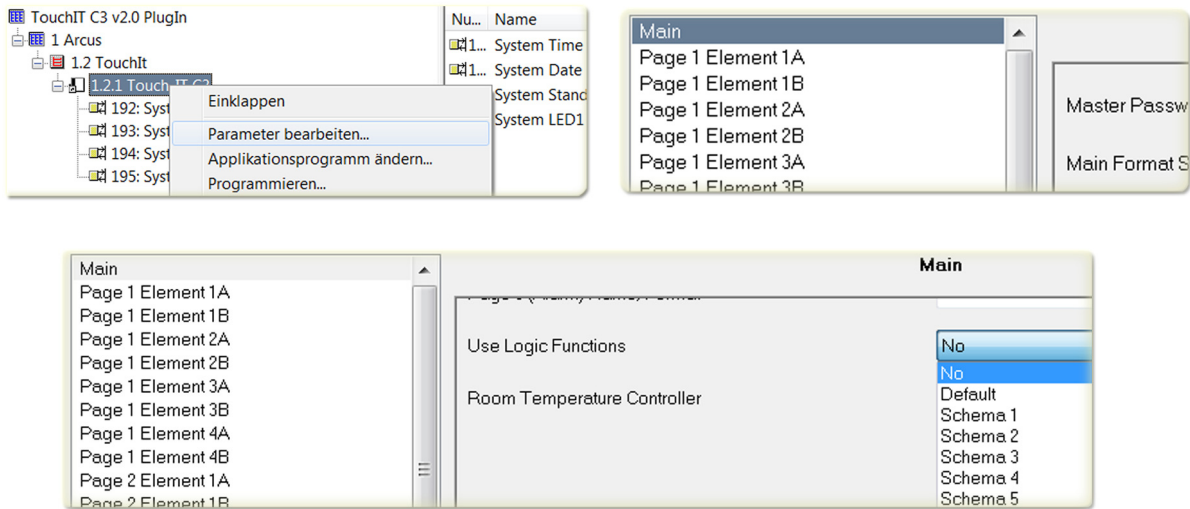

Object Schemas	Quantity	Communication Objects
No		No Objects
Default	10 x 8 x 8 x 5 x	1 Bit 1 Byte 2 Bytes 4 Bytes
Schema 1	23x 4x 2x 2x	1 Bit 1 Byte 2 Bytes 4 Bytes
Schema 2	5x 22x 2x 2x	1 Bit 1 Byte 2 Bytes 4 Bytes
Schema 3	10x 8x 12x 1x	1 Bit 1 Byte 2 Bytes 4 Bytes
Schema 4	31x	1 Bit
Schema 5	15x 16x	1 Bit 1 Byte

6.2 Functions

6.2.1 KNX Functions

Function	Example
knx.get_string(a,b,...)	X,Y,Z=knx.get_string(CO1,CO2,CO3)
Reads one or more 14-Byte strings from the objects a,b,...	
knx.set_string(a,b)	knx.set_string(CO1,"Hello World".. 3)
Writes the 14-Byte string b (Hello World 3) to a communication object (a)	
knx.get_integer(a,b,...)	X,Y,Z=knx.get_integer(48,52,56)
Reads one or more integer value(s) from the objects a,b,... (1Bit, 1Byte, 2Byte, 4Byte (un-)signed).	
knx.get_float(a,b,...)	X,Y,Z=knx.get_float(20,24)
Reads one or more float value(s) from the objects a,b,... (4Byte float).	
knx.set_integer(a,b,c)	knx.set_integer(4,2,344)
Outputs the integer value c with the length b=1..4 to a communication object a.	
knx.set_float(a,b)	knx.set_float(8,27.8)
Outputs the float value b to the communication object a.	
knx.dpt9_to_int(a)	b=knx.dpt9_to_int(Value);
Converts a 2-Byte float value into an integer value (*100).	
knx.int_to_dpt9(a)	b=knx.int_to_dpt9(Value)
Converts an integer value into a 2-Byte float value.	
knx.tx_idle(a)	knx.tx_idle(6)
Tests a communication object whether it has completed the sending process.	

6.2.2 System Functions

Function	Example
sys.timeout(a[,b])	sys.timeout(1000,233)
When a (1000 milliseconds) has elapsed, the function timeout() with the value b (233) will be executed.	
sys.set_page(a)	sys.set_page(0)
Displaying page a, leaving stand-by.	
sys.set_brightness(a)	sys.set_brightness(100)
Setting brightness to a value a (given in %).	
sys.beep(a,{b[,c]})	sys.beep(100,1500,15)
The internal beeper is activated for a (100) milliseconds, with the frequency b (1500 Hz) and the volume c (100%).	
sys.put_setting(a,b)	sys.put_setting(„test value“,10)
Creates a variable named a (test value) and sets it to the value b (10). Will be saved in the flash memory.	
sys.get_setting(a)	sys.get_setting(„test value“)
Outputs the value of the variable a (test value).	
sys.signal_obj(a)	sys.signal_obj(48)
Outputs a signal to the graphical elements that the value of object a (48) has changed.	
sys.message(a)	sys.message(„Hallo Welt“)
Opens a message dialog with the message a („Hello World“).	
sys.settings_dialog(a)	sys.settings_dialog(„table“)
Opens a dialog in order to change the settings table named a („table“).	
sys.read_settings(a)	sys.read_settings(„table“)
Reads a settings table named a („table“).	
sys.write_settings(a)	sys.write_settings(„table“)
Saves the values of the settings table a („table“) in the flash memory.	

Function	Example
settings={ {name;min;max;val;dc} }	settings={ {name="Limit1 kW";min=0.5;max=6.0;val=1.0;dc=1}; {name="Limit2 kW";min=0.5;max=6.0;val=2.5;dc=1}; }
Defines a settings table. „dc“ ist the number of decimal places displayed in the settings dialog.	

6.2.3 Callback Functions

Function	Example
knx_value_changed(x)	
Is carried out when the value of an object changes. X is the object number.	
knx_value_update(x)	
Is carried out when the value of a logical object is updated. X is the object number.	
settings_set(x)	
Is carried out when a settings dialog (x = name of the table) is closed by pressing "OK".	
timeout(x)	
Is carried as soon as a sys.timeout() occurs. x is 0 or as set in sys.timeout(a[,b]). Return 1 to stop the timeout-source 0 to continue cyclically.	

6.2.4 Example Applications

In the following example, three 4-Byte float values coming from a KNX three-phase electricity meter are analyzed and then output as graphic depictions of three 1-Byte values (0,1,2). The figure shows a traffic light. Depending on the performance one of the three colors red, yellow or green will be displayed.

The image shows two screenshots from the ETS (Energy Management System) software. The top screenshot is the 'Parameter Setting Main' window. It shows a list of elements on the left and a configuration area on the right. In the 'Main' section, the 'Main Format String' is set to 'Arcus; LOGIC=Wirkleistung;'. A red '1.' points to this string. Below it, the 'Use Logic Functions' checkbox is checked, with a red '2.' pointing to it. The 'Room Temperature Controller' is set to 'None'. The bottom screenshot is the 'ETS Topologie' window, showing a table of objects. The table has columns for Nummer, Name, Funktion, Beschreibung, Gruppenadressen, Länge, K, L, S, Ü, A, and Datentyp. A row with Nummer 232 is highlighted, showing 'IO, Logic' and 'Logic 1-Byte IO 1'.

Touch_IT	
	<p>Operating the button „Logic“ will open the limits preset page.</p>
	<p>It is possible to predefine 2 different limits.</p> <ul style="list-style-type: none"> • Limit 1 (e.g. 1000W) • Limit 2 (e.g. 2500W)
	<p>The operating page displays the current performance values. The graphics depend on the pre-defined limits.</p>



Source Code

```

settings={
  {name="Limit1 kW";min=0.5;max=6.0;val=1.0;dc=1.0};
  {name="Limit2 kW";min=0.5;max=6.0;val=2.5;dc=1.0};
}

last_states={ -1;-1;-1 }; --last-state

function settings_set(x)
  sys.write_settings(x)
  knx_value_changed(248) --KO 248
  knx_value_changed(249) --KO 249
  knx_value_changed(250) --KO 250
end

function knx_value_changed(x)
  if ( x == 248 ) then
    val=knx.get_float(x);
    state=0;
    if (val>(settings[2].val*1000)) then
      state= 2;
    elseif (val >(settings[1].val*1000)) then
      state= 1;
    end
    if (state ~= last_states[1]) then
      last_states[1]=state;
      knx.set_integer(232,1,state)
    end
  end
  if ( x == 249 ) then
    val=knx.get_float(x);
    state=0;
    if (val>(settings[2].val*1000)) then
      state= 2;
    elseif (val >(settings[1].val*1000)) then
      state= 1;
    end
    if (state ~= last_states[2]) then
      last_states[2]=state;
      knx.set_integer(233,1,state)
    end
  end
  if ( x == 250 ) then
    val=knx.get_float(x);
    state=0;
    if (val>(settings[2].val*1000)) then
      state= 2;
    elseif (val >(settings[1].val*1000)) then
      state= 1;
    end
    if (state ~= last_states[3]) then
      last_states[3]=state;
      knx.set_integer(234,1,state)
    end
  end
end

function knx_value_update(x)
  knx_value_changed(x)
end

sys.read_settings("settings")

```

7 Update Tool

The following section describes the different functionality of the Touch_IT Updater.
The Tool contains several functions e.g.:
Firmware update, Upload Screensavers, User Icons, , Logic files, etc.

7.1 Software Installation

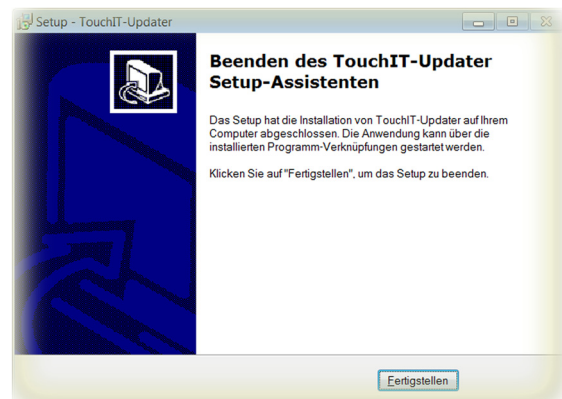
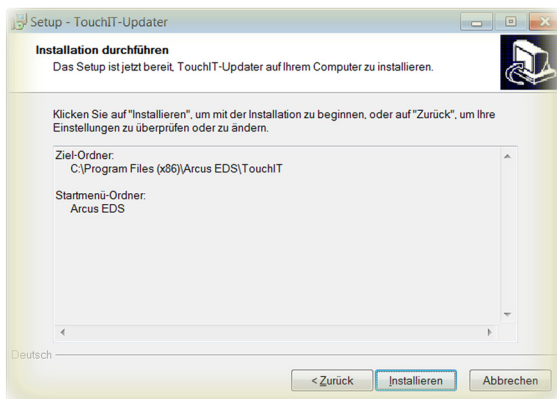
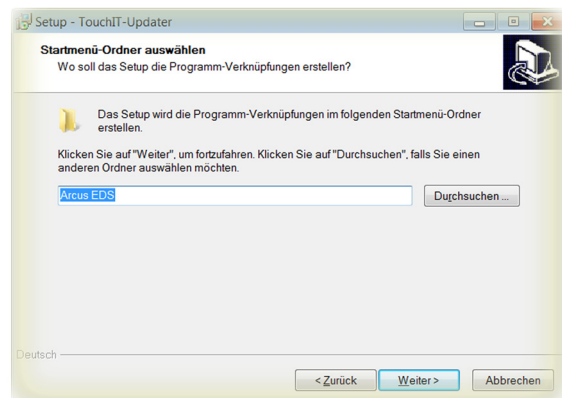
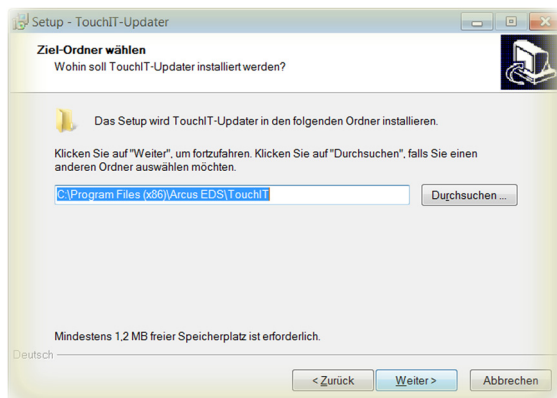
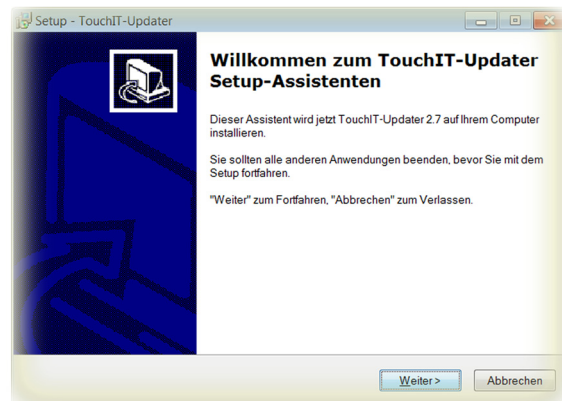
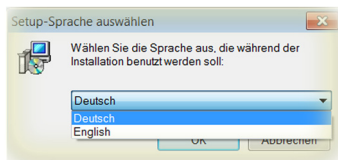

When finishing the installation, a folder containing the 32-Bit and the 64-Bit Touch_IT drivers will be created.

7.2 Driver Installation

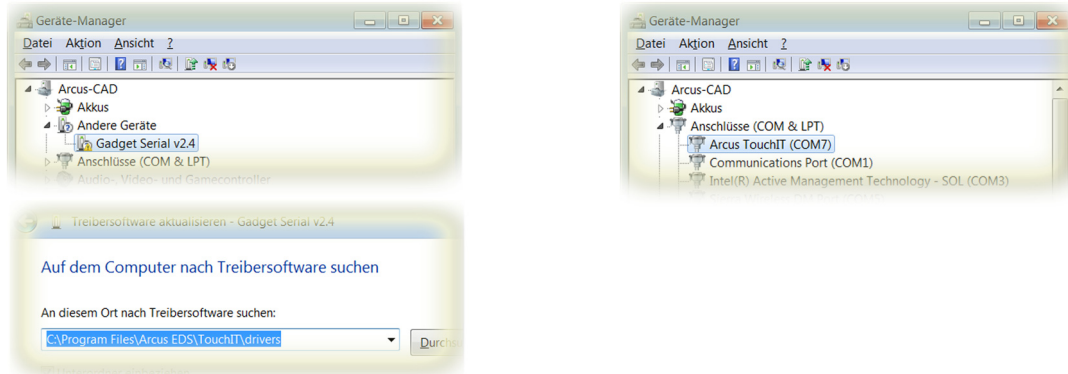

The drivers are located in the folder **drivers** of the installation path.
When the installation of the drivers is finished, an additional serial interface will be registered in the Device Manager.
In this example, the serial interface **COM7** was assigned to the Touch_IT.

7.3 Service Tool

The update tool is located in the folder **Arcus-EDS** of the start menu and can be started by operating **Run Touch_IT-Updater**.

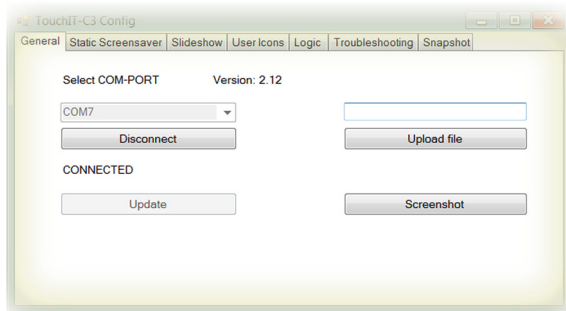

General

Select COM-PORT

must be set to the port that was assigned to the Arcus-EDS Touch_IT by the system. (See also Control Panel / System / Device Manager - connections) (here: COM7)

Update

It will be updated all system components.

Upload File

makes it possible to directly transfer files to any desired storage position of the Touch_IT.

Screenshot

saves the current display of the Touch_IT as an image file on your computer.

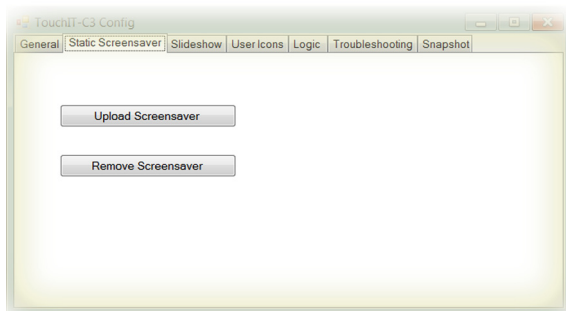

Static Screensaver

Upload Screensaver

can be used to upload an image that is to be used as static screensaver.

Remove Screensaver

deletes the current static screen saver

supported formats:

PNG	BMP	JPG
-----	-----	-----

The resolution of the display is 320x240 pixels.

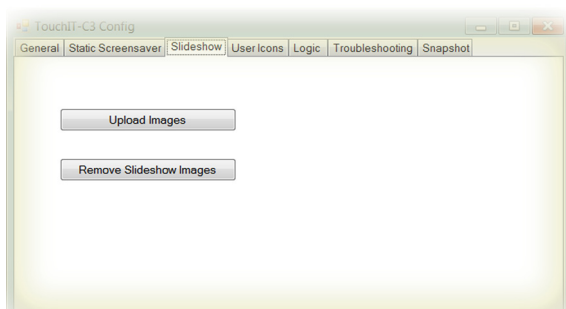

Slideshow

Upload Images

can be used to upload slideshow images that are to be used in the screensaver.

Remove Slideshow Images

can be used to upload slideshow images that are to be u

supported formats:

PNG	BMP	JPG	GIF
-----	-----	-----	-----

The resolution of the display is 320x240 pixels.

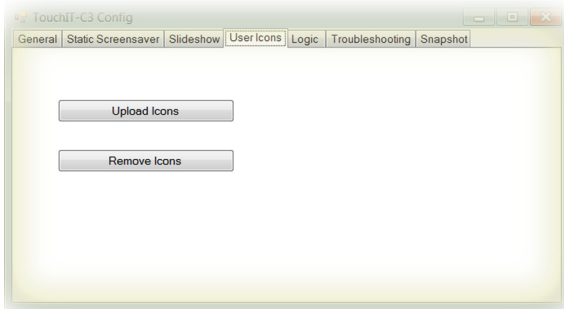

User Icons

Upload Icons

can be used to upload custom symbols and icons that are to be used as operating elements.

Remove Icons

deletes custom symbols and icons

The specification of the size and the assignment of names will be explained in chapter 8, **Custom Properties**.

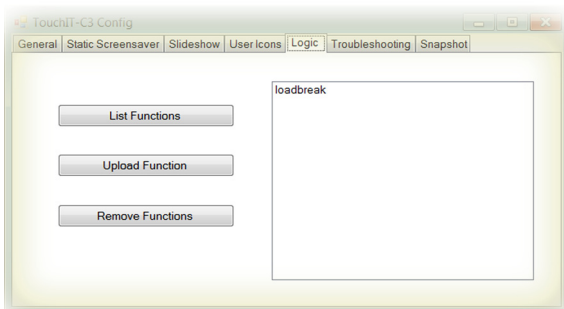

Logic

List Functions

lists all logical functions

Upload Function

serves to upload logical functions

Remove Funktion

deletes selected logical functions

More information on logic can be found in chapter 6, **Logic**.

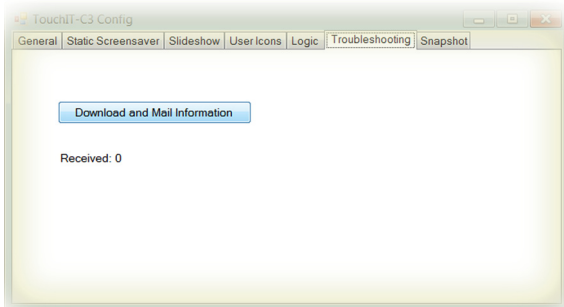

Troubleshooting

Download and Mail Information

If downloading via ETS is not possible or other malfunctions occur, all settings and parameters of the Touch_IT can be downloaded using the Troubleshooting tab. The file can be sent to Arcus-EDS GmbH via email (service@arcus-eds.de) for error analysis.

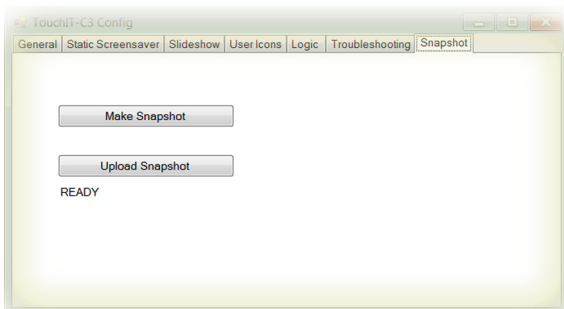

Troubleshooting

Make Snapshot

creates an exact copy of the configuration of a Touch_IT.

The snapshot includes:

- all predefined system settings (font size, time presets for screensaver and standby, etc.)
- Static screensaver image
- Slideshow images for the screensaver
- Custom icons and symbols
- Logical functions

Upload Snapshot

serves to upload an existing snapshot

8 Custom Properties

The following section describes the characteristics and requirements of the given and the highly customizable icons.

8.1 General

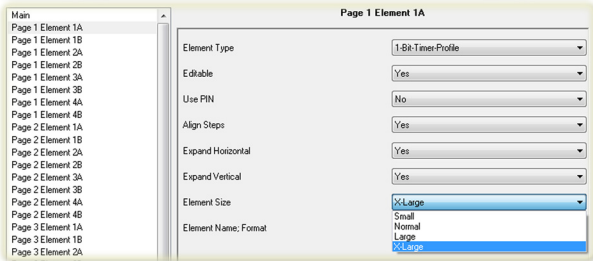

The element size can be defined using the ETS. There are four sizes available:

- Small
- Normal
- Large
- X-Large

Internally, there are 3 different icon sizes available.

- 16x16 Pixel
- 32x32 Pixel
- Custom size

Classification		
ETS Element Size	Button	Label
Small	16x16 Pixel	16x16 Pixel
Normal	16x16 Pixel	32x32 Pixel
Large	32x32 Pixel	32x32 Pixel
X-Large	32x32 Pixel	32x32 Pixel

Remark:

Custom icons are not classified.

8.2 User Defined

8.2.1 1-Bit ON/OFF Control Widgets

Naming convention		
Button	xxx_b_on.png	xxx_b_off.png
Label	xxx_l_on.png	xxx_l_off.png

Icons can be named with a freely selectable prefix. The suffix must be chosen according to the naming convention.

Examples	
	shutter_b_on.png
	shutter_b_off.png
	shutter_l_on.png
	shutter_l_off.png
ETS Parameter Element name;format	;IMGSET=shutter;





Control elements working with this naming convention:

- 1-bit-ON/OFF-Toggle-Picture
- 1-bit-ON/OFF-Toggle-Picture with value
- 1-bit-ON/OFF-Picture with value

8.2.2 Slider / Dimmer / Shutter Widgets

Naming convention		
Button	xxx_up.png	xxx_down.png
Label	xxx_l_on.png	xxx_l_off.png

Icons can be named with a freely selectable prefix. The suffix must be chosen according to the naming convention.

Beispiele	
	light_up.png
	light_down.png
	light_l_on.png
	light_l_off.png
ETS Parameter Element name;format	;IMGSET=light;





Control elements working with this naming convention:

- 1-Byte-Value-Picture-Button
- 1-Byte-Value-Slider
- 2-Byte-Value-Picture-Button
- 2-Byte-Value-Slider
- 2-Byte-Float-Picture-Button
- 2-Byte-Float-Slider
- 4-Byte-Float-Picture-Button
- 4-Byte-Float-Slider
- RGB-Dimmer
- 4-Bit-Dimmer
- 8-Bit-Dimmer
- Shutter-Blinds-Control

8.2.3 Pushbuttons/Profiles/Control Widgets

Naming convention	
Button	xxx.png

Names of icons can be freely selected.

Examples	
	ok.png
	first-aid.png
	sun.png
	bell.png
ETS Parameter Element name;format	;IMG=bell;



Control elements working with this naming convention:

- 1-Bit-Value-Pushbutton
- 1-Bit-Timer-Profile
- 1-Byte-Value-Pushbutton
- 1-Byte-Timer-Profile
- 2-Byte-Value-Pushbutton
- 2-Byte-Float-Value-Pushbutton
- 2-Byte-Float-Timer-Profile
- 4-Byte-Value-Pushbutton
- 4-Byte-Float-Value-Pushbutton
- 14-Byte-String-Pushbutton

8.2.4 IMGVAL Widgets

Naming convention	
Label	xxx

Names of icons can be freely selected.

Examples	
	ampel_0
	ampel_1
	ampel_2
ETS Parameter Element name;format	;IMGVAL=ampel;

Control element working with this naming convention:



- 1-Byte-Value-Picture-Button

Remark:
For the value "0" must be an image defined.
The format must be PNG. To upload the extension must be removed.

8.2.5 QUAD Widgets

Naming convention		
Label	xxx_l_on.png	xxx_l_off.png

Icons can be named with a freely selectable prefix. The suffix must be chosen according to the naming convention.

Examples	
	light_l_on.png
	light_l_off.png
ETS Parameter Element name;format	;IMGSET=light;

Control elements working with this naming convention:

- 1-bit-Quad-ON/OFF-Status/Toggle-Picture
- 1-bit-Quad-Value-Pushbutton-Picture

8.3 Default set of icons

Name	Label ON	Label OFF	Button ON	Button OFF	Button UP	Button DOWN
1staid						
acc_cancel						
bell						
bass						
dnd						
door						
err_pause						
shutter						
green_red						
guest						
in_out						
light						
lightbulb						
mur						
sound						
socket						
treble						
volume						
window						

Imprint

Editor: Arcus-EDS GmbH, Rigaer Str. 88, 10247 Berlin

Responsible for the contents: Hjalmar Hevers, Reinhard Pegelow

Reprinting in part or in whole is only permitted with the prior permission of Arcus-EDS GmbH.

All information is supplied without liability. Technical specifications and prices can be subject to change.

Liability

The choice of the devices and the assessment of their suitability for a specified purpose lie solely in the responsibility of the buyer. Arcus-EDS does not take any liability or warranty for their suitability. Product specifications in catalogues and data sheets do not represent the assurance of certain properties, but derive from experience values and measurements. A liability of Arcus-EDS for damages caused by incorrect operation/projecting or malfunction of devices is excluded. The operator/project developer has to make sure that incorrect operation, planning errors and malfunctions cannot cause subsequent damages.

Safety Regulations

Attention! Installation and mounting must be carried out by a qualified electrician.

The buyer/operator of the facility has to make sure that all relevant safety regulations, issued by VDE, TÜV and the responsible energy suppliers are respected. There is no warranty for defects and damages caused by improper use of the devices or by non-compliance with the operating manuals.

Warranty

We take over guarantees as required by law.

Please contact us if malfunctions occur. In this case, please send the device including a description of the error to the company's address named below.

Manufacturer



Registered Trademarks



The CE trademark is a curb market sign that exclusively directs to authorities and does not include any assurance of product properties.



Registered trademark of the Konnex Association.