

Transmitter 230 V wave UP 110
5WG3 110-2AB11

Product and Applications Description

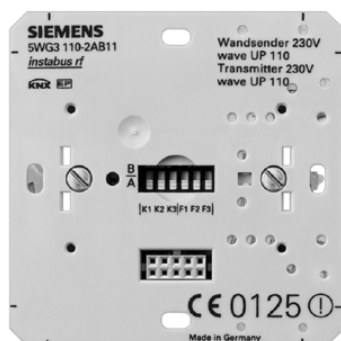

Diagram A

The transmitter 230V wave UP 110 (Diagram A) is a flush-mounted device with radio communication for the wireless operation of room functions. It is possible to connect a 1-fold or 2-fold *instabus* push button (to be ordered separately) or a motion detector (in development) via a 10-pin plug-in connector. Via the push button rocker(s) of a plug-in *instabus* push button, it is possible to operate other radio-controlled actuators and to store and retrieve scenes in the actuators via remote control.

The transmitter 230V wave is connected to the 230V network and supplied with current via an integrated power supply unit.

When the operator interface is removed, the commissioning of the transmitter 230V wave is carried out without any special tools via the six DIL switches located at the front of the device (Easy mode Push Button: EP).

There are two different operation modes for the transmitter 230V wave:

Normal function

- With an *instabus* push button: operation of other actuators that are linked via radio, storing and retrieving of scenes
- With a motion detector: reporting of detected movements to other devices that are linked via radio

Special function

- Establishing connections to other radio-controlled components
- Deleting connections to other radio-controlled components

Operation

The 1-fold or 2-fold *instabus* push button placed on the transmitter 230V wave can be operated at the TOP or BOTTOM. The exact operational functionality depends

on the devices connected via radio control: switching, dimming, shutter control or scene function.

Switching (Actions shorter than 0.4s):

TOP In connection with a switch actuator: ON;
in connection with a dimmer: switching ON with dimming to the saved memory value

BOTTOM OFF

Dimming (Actions longer than 0.4s):

TOP Dimming BRIGHTER up to max. light intensity

BOTTOM Dimming DARKER down to min. light intensity

Shutter STEP command (Actions shorter than 0.4s):

TOP STOP/OPEN slats (by 1 step)

BOTTOM STOP/CLOSE slats (by 1 step)

Shutter UP/DOWN command (Actions longer than 0.4s):

TOP UP command

BOTTOM DOWN command

Scene function:

Preselected states for the lighting (ON or OFF or any brightness value) and the shutters (UP or DOWN) can be saved in a scene and reset via a push button action. Up to four scenes can be saved and retrieved with the transmitter 230V wave. If a 1-fold *instabus* push button is used, scenes 1 and 2 are operated via the rocker. If a 2-fold *instabus* push button is used, scenes 1 and 2 are operated via the left rocker and scenes 3 and 4 are operated via the right rocker.

Before saving a scene, each switch, dimmer and shutter control insert sys or radio-controlled actuator that is linked via radio must be set to the state to be stored:

- Switch actuator: ON or OFF
- Dimmer: Desired light intensity value
- Shutter: TOP or BOTTOM (limit position)

a) Saving scenes (Actions longer than 3s):

When saving a scene, each connected actuator saves the current state under the activated scene number.

TOP Saves scene 1 (or scene 3 when operating the right rocker of the 2-fold push button)

BOTTOM Saves scene 2 (or scene 4 when operating the right rocker of the 2-fold push button)

b) Retrieving scenes (Actions shorter than 0.4s):

When retrieving a scene, each connected actuator is set to the state that has been stored under this scene number.

TOP Retrieves scene 1 (or scene 3 when operating the right rocker of the 2-fold push button)

BOTTOM Retrieves scene 2 (or scene 4 when operating the right rocker of the 2-fold push button)

Technical Specifications

Frequency band

868 MHz (transmission is not susceptible to interference; frequency band reserved for system and security applications)

Range of radio control

approx. 100 m (applying to free field applications)

Power supply

via the 230V mains connection,
rated voltage: AC 230V, 50Hz

Connections

- 2 screw terminals for mains connection;
Insulation strip length: approx. 5 mm
The following conductors are permitted per screw terminal:
 - two solid conductors 0.5 to 1.5 mm²
 - one solid or finely-stranded conductor 0.5 to 2.5 mm²
- 10-pole socket connector for the connection of a 1-fold or 2-fold *instabus* push button

Mechanical specifications

- Housing: plastic
- Dimensions: Spacer units: 71 x 71mm
 - Mounting depth: 32 mm
- Weight: approx. 65 g
- Fire load: approx. 1000 kJ
- Mounting: inserted in box mounts according to DIN 49073-1, Ø 60 mm, min. depth 40 mm.

Electrical safety

- Pollution degree (acc. to IEC 60664-1): 2
- Protection (acc. to EN 60529): IP 20
- Overvoltage category (acc. to IEC 60664-1): III
- Device complies with EN 60669-2-1

Electromagnetic compatibility

complies with EN 300-220, EN 301-489, EN 60669-2-1

Environmental specifications

- Climatic conditions: EN 50090-2-2
- Ambient operating temperature: - 5 ... + 45°C
- Storage temperature: - 25 ... + 70°C
- Relative humidity (non-condensing): 5% to 93%

Certification

VDE certificate in preparation, complies with  - standard

radio frequency rf

easy mode push button 

CE norm

complies with the EMC regulations (residential buildings), low voltage regulations and R&TTE regulations:



The CE declaration can be inspected at:

SIEMENS AG
Siemensstraße 10
93055 Regensburg

Installations Instructions

Caution:

- The installation of the device into metal walls has to be avoided since this considerably reduces the range of radio control.
- Occasionally the transmission range may be influenced by structural conditions (e.g. reinforced concrete) or electric / electronic sources of interference.
- A minimum distance of 1 m must be maintained between the transmitter and the relevant receivers.
- Though the radio transmission is carried out in the safe 868 MHz range, disruptions to the radio transmission cannot be excluded.
- The used radio transmission is not suitable for security applications.



DANGER

- The device may be used for interior installations and in dry rooms only.
- The device must be mounted and commissioned by an authorised electrician.
- The device must not be opened.
- The device may be mounted in switch and socket combination box mounts provided that only VDE-certified devices are used.
- The prevailing safety and accident regulations must be observed.

Transmitter 230 V wave UP 110

5WG3 110-2AB11

Mounting

The transmitter 230V wave is connected to the mains cable (L and N conductor) (**Diagram B**) and inserted in a boxmount (Ø 60 mm and 40 mm depth) using screw or claw fixing. A 1-fold or 2-fold *instabus* push button or a motion detector with the relevant frame (to be ordered separately) is placed on the transmitter 230V wave with guide and mounting clamps (**Diagram C**).

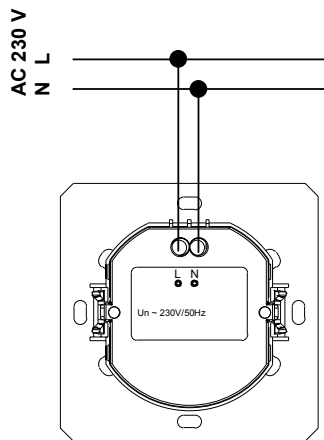

Diagram B

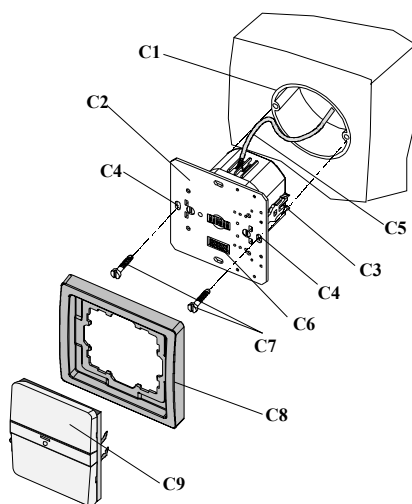

Diagram C

- C1 Installation box (60 mm Ø, acc. to DIN 49073-1)
- C2 Transmitter 230V wave UP 110
- C3 Mounting claws
- C4 Mounting slots for screw fixing
- C5 Cable for mains connection
- C6 10-pole socket connector
- C7 Mounting screws
- C8 Frame
- C9 *instabus* push button

Location and Function of the Display and Operating Elements

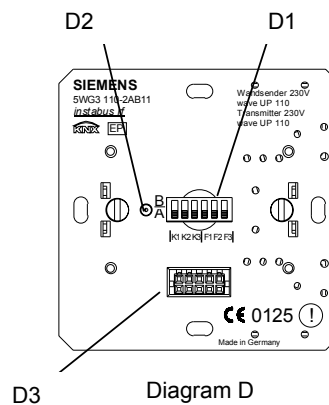
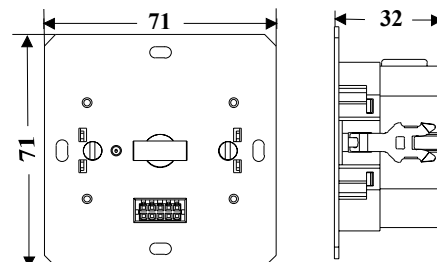

Diagram D

- D1 DIL switches for selecting the function and connecting the transmitter actuator via radio control
- D2 LED for displaying the operating state while the connections to other radio control components are established
- D3 10-pole socket connector for connecting an *instabus* push button or a motion detector

Dimension Diagram

Dimensions in mm



Commissioning

Note: The transmitter 230V wave must be connected to the 230V cable for the commissioning. The commissioning is carried out without the *instabus* push button via the 6 DIL switches (D1) located at the front and is indicated via the flashing of the LED (D2) located beside the DIL switches.

Function of the DIL switches

Diagram E shows the DIL switches in the supplied state. In the lower switch position, a DIL switch is switched off (A=OFF) while it is switched on in the upper switch position (B=ON). Before connecting a rocker, all the DIL switches should be switched off.

Switches **K1 to K3** are used for the **assignment of the channels**. If a 1-fold *instabus* push button is used or when using a motion detector, DIL switch K1 must be used for commissioning the device. If a 2-fold *instabus* push button is implemented, DIL switch K1 is required for commissioning the left rocker while DIL switch K2 is required for commissioning the right rocker. DIL switch K3 is only needed during the start of a master reset.

- K1** 1-fold rocker or left rocker, motion detector
- K2** Right rocker
- K3** (only to be operated when starting a master reset)

The DIL switches **F1 to F3** can be used for **setting the available functions** of switching, switching/ dimming, shutter control or scene function when the transmitter is operated with an push button or for selecting the motion detector function when the transmitter is operated with a motion detector.



Diagram E

Diagram F shows various switch displays that are used in the subsequent diagrams to explain the commissioning process.

Diagram F1 is used to display a **triggered action**. If the switch is moved from the position A to the position B, a connection via radio is triggered.

Diagram F2 is used to show a **position** which the relevant DIL switch must occupy.

Diagram F3 indicates that the relevant DIL switch must first be switched to the corresponding position according to the required function.

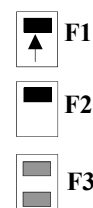

Diagram F

Diagram G shows which position the **function switches F1 to F3** must be switched to in order to **preselect a specified function**:

Diagram G1 Function: **Switching**

Diagram G2 Function: **Switching / Dimming**

Diagram G3 Function: **Shutter control**

Diagram G4 Function: **Scene control**

Diagram G5 Function: **Detection of movement**

Afterwards only one of the channel switches K1 or K2 has to be switched to position B.

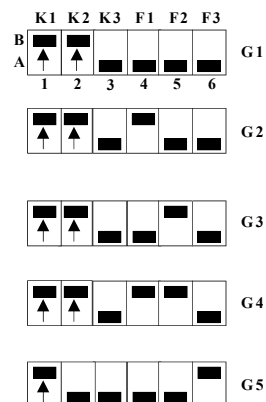

Diagram G

Connection via radio control:

Diagrams H and J indicate the connection of the rocker or the left rocker of a transmitter 230V wave with a single rocker or a twin rocker with a radio-controlled actuator e.g. a switch insert sys with a plug-in push button wave.

H1 Transmitter 230V wave UP 110

H2 Push button wave UP 210

H3 Switch insert sys

Transmitter 230 V wave UP 110

5WG3 110-2AB11

- 1. Radio-controlled actuator:** Switch to the **special function**. (see the commissioning instructions of the radio controlled actuator)
- 2. Transmitter:** Select the required function via the DIL switches F1 and F2 according to diagram G.
- 3. Transmitter: Trigger a connection telegram** via DIL switch K1 (**Diagram J**).

Action: Switch DIL switch K1 to position B. The transmitter sends a connection telegram.

Display: When K1 has been toggled, the LED of the transmitter wave flashes slowly for approx. 2 seconds (approx. once per second). After a successful connection, the LED flashes rapidly for approx. 2 seconds (approx. twice per second) and is then extinguished. If a connection cannot be established, the LED is already extinguished after the first period of 2 seconds when it was flashing slowly. The teaching-in process must then be repeated.

- 4. Transmitter: Reset** all the DIL switches to A.

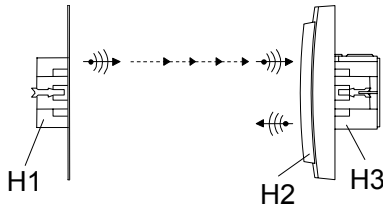

Diagram H

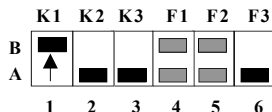

Diagram J

Note:

If the DIL switches are inadvertently not reset to position A after the connection, this is indicated by the LED of the plug-in *instabus* push button which continuously flashes at a rapid rate.

If the transmitter 230V wave should be connected to other radio-controlled actuators, the process described above should be repeated for each actuator.

When using a 2-fold push button, if the right rocker should be linked with a radio-controlled actuator, the above procedure should be repeated, whereby the sending of the connection telegram must now be triggered by the toggling of DIL switch K2 (**Diagram K**).

An unlimited number of radio-controlled actuators can be operated remotely via the rockers of a transmitter 230V wave. Switch and dimmer inserts can be operated to-

gether. The common operation of dimming and shutter functions is however only possible via scenes.

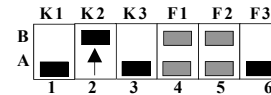

Diagram K

Connecting a scene function via radio control:

Use of a double *instabus* push button for control of 4 scenes.

- Radio controlled actuator: Switch to the special function.
- Transmitter: Select the scene function via DIL switch F1 and F2.
- Transmitter: Trigger linking telegram via DIL switch K1 (for the left rocker; Scene 1 and 2).
- Transmitter: Switch DIL switch K1 back to position A.
- Radio controlled actuator: Switch to the special function again.
- Transmitter: Trigger linking telegram via DIL switch K2 (for the right rocker; Scene 3 and 4).

Repeat steps 1 to 6 for each further radio controlled actuator that is involved in scene function.

- Transmitter: Switch all DIL switches back to position A.

Deleting a link via radio control:

The deletion of a connection is carried out by a new assignment (see "Connection via radio control").

Master reset

(Resetting the device to the supplied state, **Diagram L**)



Diagram L

Prerequisite: No other radio-controlled device may be switched to the special function.

- First set the DIL switches F1 to F3 and then the DIL switches K1 to K3 to B and wait 10 seconds.
- Reset all the DIL switches to A.

Once all the DIL switches have been toggled the LED of the transmitter flashes quicker and quicker and is extinguished after approx. 10 seconds. All the previously stored associations and connections are then deleted.

If one of the DIL switches will be switched to A before the deletion of the LED the master reset will be stopped and all previous associations will be retained.

Technical Product Information

January 2005

Transmitter 230 V wave UP 110

5WG3 110-2AB11

General Notes

- The operating instructions must be handed over to the client.
- Any faulty devices should be returned to the local Siemens office.
- If you have further questions concerning the product please contact our technical support:

 +49 (0) 180 50 50-222
 +49 (0) 180 50 50-223
 adsupport@siemens.com
 www.siemens.de/automation/support-request

Notes