

Brightness Controller GE 253
 42 x 28 mm

5WG1 253-4AB01

Product and Applications Description



The GE 253 brightness controller is used for measuring the outdoor brightness (light intensity) next to the window and consists of a converter and a receiver (light sensor) with a 2 m connecting lead. The converter is an oblong device and is therefore suited for surface mounting, e.g. for fitting in raised ceilings. The receiver should be mounted e.g. interior, next to the window with the mounting kit included.

The actual light intensity value as measured by the receiver is sent on the bus via the converter for evaluation of the outside lighting conditions by the light intensity control module N 342. Additionally, the light intensity value can be read via the bus for example showing it on a display device.

With the ETS (*EIB Tool Software*) the application program is selected, its parameters and addresses are assigned appropriately, and downloaded to the brightness controller GE 253.

Application Programs

12 S1 LuxVal 210D02

- allows to send Lux-value
- release / lock-out modes available
- send conditions can be specified
- characteristic after commissioning can be specified

Example of Operation

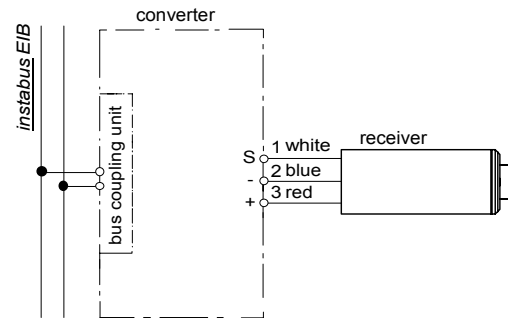

Installation Instructions

- The device may be used within casings or other devices, or surface mounted.



WARNING

- The device must be mounted and commissioned by an authorised electrician.
- Take care that 230 V devices that are used in combination with this device provide a basic insulation of 250 V to the line; otherwise a safety distance of 4 mm must be kept. If in doubt, extra insulation should be added.
- The receiver cable must be installed according to DIN VDE 0800.
- The prevailing safety rules must be heeded.
- The device must not be opened. A device suspected faulty should be returned to the local Siemens office.

Technical Specifications

Unless stated otherwise, the specifications below apply both to converter and receiver.

Power supply

- converter: via bus cable
- receiver: via converter

Measuring range

0 ... 16000 Lux

Control elements

1 learning button (on converter):
for switching between normal operating mode and addressing mode

Display elements

1 red LED (on converter):
for controlling bus voltage and displaying mode, selected
by the learning button

Connections

- converter:
 - to receiver, screwless plug-in terminals:
0,25 ... 0,75 mm² single core
 - to bus line, screwless bus connection blocks:
0,6 ... 0,8 mm Ø single core
- receiver:
 - connection cable to converter,
length: 2 m Ø, 3 x 0,6 mm, non-extendable,
sheathing Ø: max. 5,5 mm

Physical specifications

- housing: plastic
- dimensions (W x H x L):
 - converter: 42 x 28 x 274,5 mm
 - receiver: 25 x 26 x 77,4 mm
- weight:
 - converter: approx. 190 g
 - receiver: approx. 100 g
- fire load (converter and receiver): approx. 4300 kJ ± 10 %
- installation:
 - converter: screw-mounted, in devices
 - receiver: mounted to ceilings

Electrical safety

- fouling class (according to IEC 664-1): 2
- protection (according to EN 60529): IP 20
- protection class (according to IEC 1140): III
- overvoltage class (according to IEC 664-1): III
- bus: safety extra low voltage SELV DC 24 V
- device complies with
EN 50 09020-2-2 and IEC 664-1: 1992

Reliability

rate of failure: 694 fit at 40 °C

Electromagnetic compatibility

complies with
EN 50081-1, EN 50082-2 and EN 50090-2-2

Environmental specifications

- climatic conditions: EN 50090-2-2
- ambient temperature operating: - 5 ... + 45 °C
- ambient temperature non-op.: - 25 ... + 70 °C
- relative humidity (non-condensing): 5 % to 93 %

Certification

EIB certificate

CE norm

complies with the EMC regulations (residential and
functional buildings), and low voltage regulations

Location and Function of the Display and Operator Elements

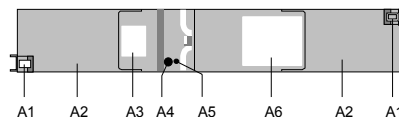

Figure 1: Location of the display and operator elements

- A1 Levers for snapping the cover lids shut
- A2 Cover lids of the connection block compartments
- A3 Label for noting the physical address
- A4 Learning button for switching between normal
operating mode and addressing mode for receiving
the physical address
- A5 LED for indicating normal operating mode (LED off)
and addressing mode (LED on); upon receiving the
physical address the device automatically returns to
normal operating mode
- A6 Type plate

Brightness Controller GE 253
42 x 28 mm

5WG1 253-4AB01

Mounting and Wiring of the Converter

General description

The devices can be built into casings or mounted separately with two screws, \varnothing 4 mm.

Opening the connection block compartment (Figure 2)

- Press the snap levers (A1) outwards (black arrows) and remove the cover lids (A2) of the compartments.

Closing the connection block compartment (Figure 2)

- Press the cover (A2) down until it clicks into place.

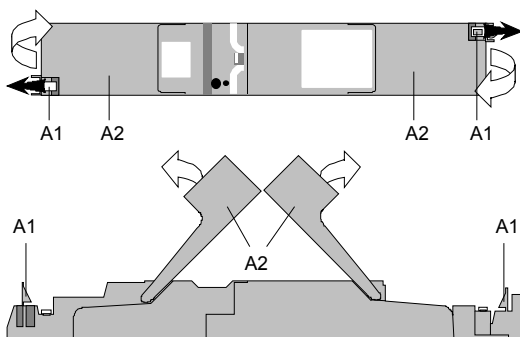

Figure 2: Opening and closing the cover lids

Slipping off bus connection blocks (Figure 3)

- The bus connection block (B3) is situated in the left connection block compartment. It consists of two components (B3.2 and B3.3) with four terminal contacts each. Take care not to damage the two test sockets (B3.1) by accidentally connecting them to the bus cable or with the screw-driver (e.g. when attempting to unplug the bus connection block).
- Carefully put the screw driver to the wire-inserting slit of the bus connection block's grey component (B3.3) and pull the bus connection block (B3) from the built-in device. When removing the red component of the bus connection block, the grey component remains in the compartment.

Note: Don't try to remove the bus connection block from the bottom side! There is a risk of shorting-out the device.

Slipping on bus connection blocks (Figure 3)

- Slip the bus connection block onto the guide slot and
- press the bus connection block (B3) down to the stop.

Connecting bus cables (Figure 3 "A")

- The bus connection block (B3) can be used with single core conductors \varnothing 0,6 ... 0,8 mm.

- Remove approx. 5 mm of insulation from the conductor (B3.4) and plug it into the bus connection block (B3) (red = +, black = -).
- The sheathing of the bus cable must be attached to the casing of the built-in device via the conductor fixing (B1). When using a cable with shielding, it can be screwed onto the terminal (B6, Figure 3).

The recess (B2) can be used to accommodate an overvoltage protection which is connected to the bus connection block in parallel with the bus line (Figure 3).

Disconnecting bus cables (Figure 3 "A")

- Unplug the bus connection block (B3) and remove the bus cable conductor (B3.4) while simultaneously wiggling it.

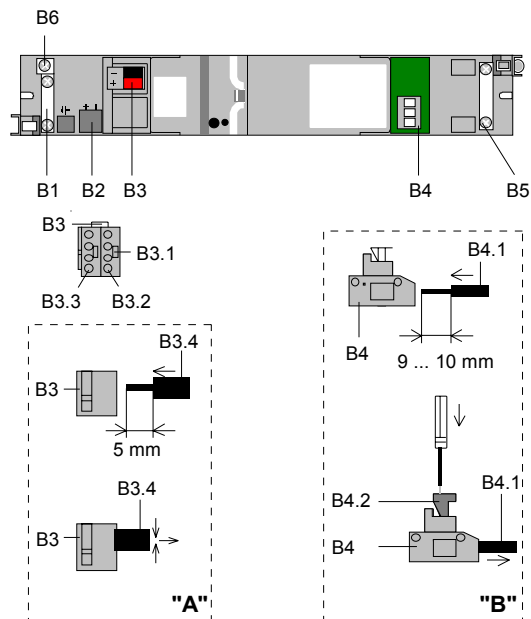

Figure 3: Connections

Connecting receiver cable (Figure 3 "B")

- The receiver cable is connected to screwless plug-in terminals (B4).
- Remove approx. 9 to 10 mm of insulation from the wire (B4.1) and plug it into the terminal (B4).
- The sheathing of the receiver cable must be attached to the casing of the built-in device via the cable clamp (B5, Figure 3).

Brightness Controller GE 253
42 x 28 mm

5WG1 253-4AB01

- Plug-in terminals assignment:



Disconnecting receiver cable (Figure 3 "B")

- Press the terminal lock (B4.2) with a screw driver and
- remove the connector (B4.1) from the terminal (B4).

Mounting and wiring of the receiver (Figure 4)

The included adapter (C2) allows to mount the receiver (C1) horizontally. The adapter is slid onto the guide (C3) on the receiver.

The receiver of the brightness controller GE 253 must be placed with the intake pointing outwards horizontally and firmly fixed at the window. It must be mounted to windows that cannot be opened.

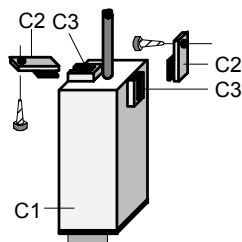
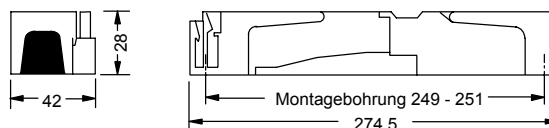

Figure 4: Mounting the receiver

Dimension Diagram

Dimensions in mm

Converter:



Receiver:

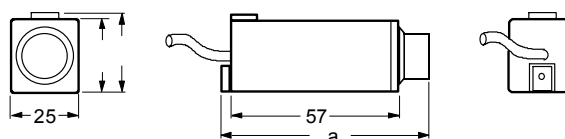

a = 65,5 mm

General notes

- Any faulty devices should be returned to the local Siemens office.
- Should you have any additional queries, please contact our Technical Support department:

☎ +49 (0) 180 50 50-222
 ☎ +49 (0) 180 50 50-223
 ✉ adsupport@siemens.com
 🌐 www.siemens.com/automation/support-request