

Brightness Controller GE 252
 42 x 28 mm

5WG1 252-4AB02

Product and Applications Description



The GE 252 brightness controller can be used for measuring and regulating the workplace illumination and / or floor illumination and consists of a receiver (light sensor) with a 2 m connecting lead and a converter. The converter is an oblong device and is therefore suited for fitting in luminaires for fluorescent lamps. It can also be mounted separately. The receiver is built into ceilings with the help of a spring clamp and a ceiling rose (supplied with the controller).

The converter contains the current brightness level recorded by the receiver and controls the lighting via the *instabus EIB*.

There are various application programs for calibration, constant-light control or two-step control. The light intensity can also be read via the bus and for example be indicated on a display device.

With the ETS (*EIB Tool Software*) the application program is selected, its parameters and addresses are assigned appropriately, and downloaded to the brightness controller GE 252.

Application Programs

12 CO Calibration light sensor 710102

- allows calibration of brightness controller
- download of the lux-value measured to the brightness controller
- reading of calibration value from brightness controller (with the commissioning software)

12 S1 ConstLi 210301

- allows constant light control
- release/interlocking modes provided
- set point can be adjusted via push button
- set point hysteresis adjustable
- behaviour after commissioning can be specified

12 S1 TwoPnt 210201

- two-step light control
- timed interlocking provided
- release/interlocking modes
- threshold can be adjusted via push button
- cyclic send mode
- characteristic after commissioning can be specified
- optional use as on/off-control

12 S1 LuxVal 210401

- allows Lux-value to send
- release/interlocking modes
- send conditions can be specified
- characteristic after commissioning can be specified

Example of Operation

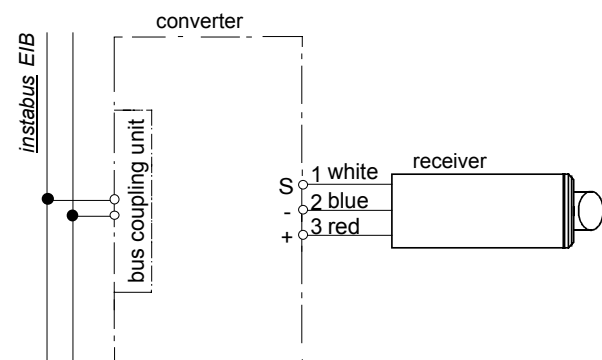

Installation Instructions

- The device may be used within casings or other devices, or surface mounted.



WARNING

- The device must be mounted and commissioned by an authorised electrician.
- Take care that 230 V devices that are used in combination with this device provide a basic insulation of 250 V to the line; otherwise a safety distance of 4 mm must be kept. If in doubt, extra insulation should be added.
- The receiver cable must be installed according to DIN VDE 0800.
- The prevailing safety rules must be heeded!
- The device must not be opened. A device suspected faulty should be returned to the local Siemens office.

Brightness Controller GE 252
42 x 28 mm

5WG1 252-4AB02

Technical Specifications

Unless stated otherwise, the below specifications apply both to converter and receiver.

Power supply

- converter: via bus cable
- receiver: via converter

Measuring range

- constant light control: 200 ... 1900 Lux
- send light intensity value: 0 ... 2000 Lux
- precision: $\pm 15\%$

Control elements

1 learning button (on converter):
for switching between normal operating mode and addressing mode

Display elements

1 red LED (on converter):
for controlling bus voltage and displaying mode, selected by the learning button

Connections

- converter:
 - to receiver, screwless plug-in terminals: 0,25 ... 0,75 mm² single core
 - to bus line, screwless bus connection blocks: $\varnothing 0,6$... 0,8 mm single core
- receiver:
 - connection cable to converter, length: 2 m $\varnothing 3 \times 0,6$ mm, non-extendable, sheathing \varnothing max. 5,5 mm

Physical specifications

- housing: plastic
- dimensions (W x H x L):
 - converter: 42 x 28 x 274,5 mm
 - receiver: 25 x 26 x 77,4 mm
- weight:
 - converter: approx. 190 g
 - receiver: approx. 100 g
- fire load (converter and receiver): approx. 4300 kJ $\pm 10\%$
- installation:
 - converter: screw-mount, in devices
 - receiver: mount to ceilings

Electrical safety

- fouling class (according to IEC 664-1): 2
- protection (according to EN 60529): IP 20
- protection class (according to IEC 1140): III
- overvoltage class (according to IEC 664-1): III
- bus: safety extra low voltage SELV DC 24 V
- device complies EN 50090-2-2 and IEC 664-1: 1992

Reliability

rate of failure: 522 fit at 40 °C

Electromagnetic compatibility

complies with EN 50081-1, EN 50082-2 and EN 50090-2-2

Environmental specifications

- climatic conditions: EN 50090-2-2
- ambient temperature operating: - 5 ... + 45 °C
- ambient temperature non-op.: - 25 ... + 70 °C
- relative humidity (non-condensing): 5 % to 93 %

Certification

EIB certificate

CE norm

complies with the EMC regulations (residential and functional buildings), and low voltage regulations

Location and Function of the Display and Operator Elements

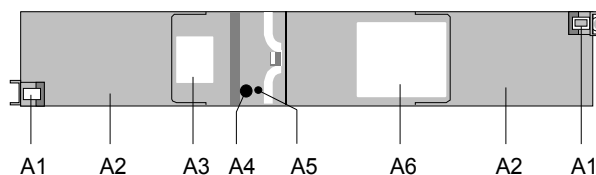

Figure 1: Location of the display and operator elements

- A1 Levers for snapping the cover lids shut
- A2 Cover lids of the connection block compartments
- A3 Label for noting the physical address
- A4 Learning button for switching between normal operating mode and addressing mode for receiving the physical address
- A5 LED for indicating normal operating mode (LED off) and addressing mode (LED on); upon receiving the physical address the device automatically returns to normal operating mode
- A6 Type plate

Brightness Controller GE 252
42 x 28 mm

5WG1 252-4AB02

Mounting and Wiring of the Converter

General description

The devices can be built into casings or mounted separately with two screws, \varnothing 4 mm.

Opening the connection block compartment (Figure 2)

- Press the snap levers (A1) outwards (black arrows) and remove the cover lids (A2) of the compartments.

Closing the connection block compartment (Figure 2)

- Press the cover (A2) down until it clicks into place.

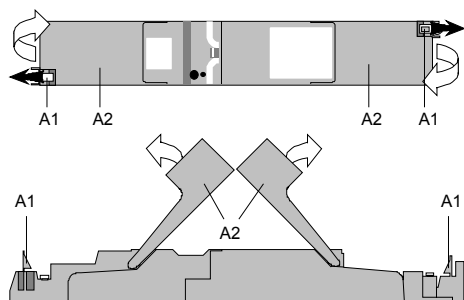

Figure 2: Opening and closing the cover lids

Slipping off bus connection blocks (Figure 3)

- The bus connection block (B3) is situated in the left connection block compartment. It consists of two components (B3.2 and B3.3) with four terminal contacts each. Take care not to damage the two test sockets (B3.1) by accidentally connecting them to the bus cable or with the screw-driver (e.g. when attempting to unplug the bus connection block).
- Carefully put the screw driver to the wire-inserting slit of the bus connection block's grey component (B3.3) and pull the bus connection block (B3) from the built-in device. When removing the red component of the bus connection block, the grey component remains in the compartment.

Note: Don't try to remove the bus connection block from the bottom side! There is a risk of shorting-out the device.

Slipping on bus connection blocks (Figure 3)

- Slip the bus connection block onto the guide slot and
- press the bus connection block (B3) down to the stop.

Connecting bus cables (Figure 3 "A")

- The bus connection block (B3) can be used with single core conductors \varnothing 0,6 ... 0,8 mm.
- Remove approx. 5 mm of insulation from the conductor (B3.4) and plug it into the bus connection block (B3) (red = +, grey = -).

- The sheathing of the bus cable must be attached to the casing of the built-in device via the conductor fixing (B1). When using a cable with shielding, it can be screwed onto the terminal (B6, Figure 3).

The recess (B2) can be used to accommodate an over-voltage protection which is connected to the bus connection block in parallel with the bus line (Figure 3).

Disconnecting bus cables (Figure 3 "A")

- Unplug the bus connection block (B3) and remove the bus cable conductor (B3.4) while simultaneously wiggling it.

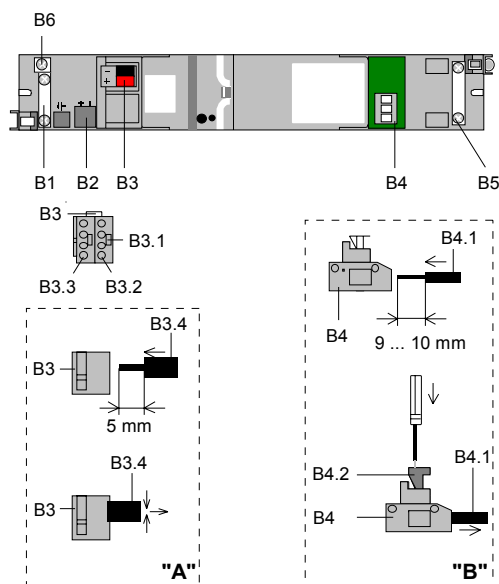
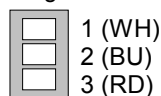

Figure 3: Connections

Connecting receiver cable (Figure 3 "B")

- The receiver cable is connected to screwless plug-in terminals (B4).
- Remove approx. 9 to 10 mm of insulation from the wire (B4.1) and plug it into the terminal (B4).
- The sheathing of the receiver cable must be attached to the casing of the built-in device via the cable clamp (B5, Figure 3).
- Plug-in terminals assignment:



Disconnecting receiver cable (Figure 3 "B")

- Press the terminal lock (B4.2) with a screw driver and
- remove the connector (B4.1) from the terminal (B4).

Mounting and Wiring of the Receiver

Mounting of the receiver (Figure 4)

The included adapter (C2) allows to mount the receiver (C1) horizontally or vertically. The adapter is slid onto the guide (C3) on the receiver. The receiver also can be fixed to a mounting support (D3).

The mounting support (D3) must provide an opening of at least $\varnothing 35$ mm for the receiver (D1). The rose (D4) is snapped onto the receiver.

The retaining spring then is slipped with its nibs (D2) from the back along the edges of the receivers casing (D1) to the front until a tight fit is achieved.

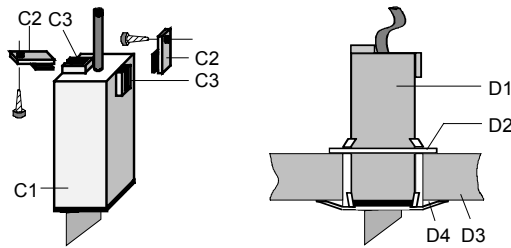

Figure 4: Mounting the receiver

Mounting height (Figure 5)

Use a height of 2.5 to 6 m above the receiving area when mounting the receiver to the ceiling.

The receiver must be adjusted along the longitudinal axis pointing vertically downwards.

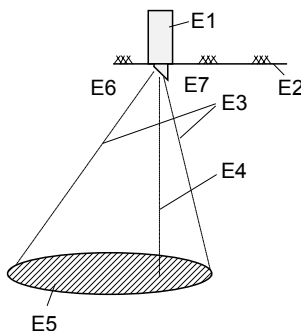

Figure 5: Mounting height GE 252

- E1 Receiver of the brightness controllers GE 252
- E2 Ceiling
- E3 Receiver cone
- E4 Longitudinal axis of the receiver
- E5 Illumination area
- E6 Angle: approx. 38°
- E7 Angle: approx. 20°

When using a mounting height of more than 6 m:

- The receiver cone grows with the mounting height. Thus, also the noise created by other light sources is increased, i.e. the measuring errors are increased to more than the stated maximum of $\pm 15\%$.
- The projected light intensity that shall be established must be increased to above 400 Lux.
- The receiver cone of multiple brightness controllers must not overlap (e.g. when arranging lines of luminaires in parallel with individual brightness controllers).

Mounting notes

- The receiver of the brightness controller GE 252 alternatively can be fixed to a mounting support (see Figure 4).
- The slanted tubus can be rotated along its longitudinal axis. It must be adjusted in order to minimise picking up light from other light sources.
 - In rooms that have only a single windowed wall, the long side of the tubus must be positioned against the window.
 - In rooms with two or three windowed walls, the long side of the tubus must be positioned against one of the walls without windows (as dark as possible).
 - In rooms with windows on all sides, the long side of the tubus must be facing northwards.
- The receiver must be mounted at least 70 cm from any wall. If this is not possible, the receiver can be mounted up to 30 cm from the wall. Then, the long side of the tubus must be adjusted to the wall.
- If the light cones of individual work place lights overlap with the receiving area of the brightness controller the measured values are corrupted which reduces the effectiveness of the control.
- Avoid arrangements where light from other sources hit the pick up directly.

Projecting Notes

Constant light control

The most effective strategy for power saving purposes is to group up to four lines of luminaires arranged in parallel (as seen from the window), as a greater distance from the window reduces the so called daylight quotient considerably.

The daylight quotient (in %) is the ratio of the outside horizontal light intensity (in Lux) to the interior daylight intensity (in Lux).

Brightness Controller GE 252
42 x 28 mm

5WG1 252-4AB02

Constant light control approaches

- Separate control of all lines of luminaires; i.e. one brightness controller (receiver) per line of luminaires, placed along the longitudinal axis of the lines of luminaires (up to four lights).
- Two to four lines of luminaires are grouped and controlled by a single brightness controller (receiver) which must be mounted in the centre between the longitudinal axis of the two outer lines of luminaires of the group.

Calculation example (Figure 6)

For the example in Figure 6 horizontal light intensity of 16000 Lux (which roughly reflects a sunny day) 6,7 m from the window (i.e. beneath the third light) results in a daylight quotient of only:
 $(16000 \times 1,8 / 100) \text{ Lux} = 288 \text{ Lux}$

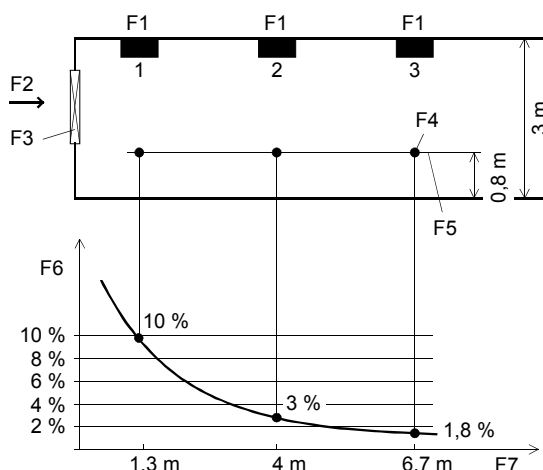

Figure 6: Calculation example

- F1 Lines of luminaires 1 ... 3
- F2 Horizontal light intensity
- F3 Window
- F4 Measuring position for the Luxmeter
- F5 Working area
- F6 Daylight quotient
- F7 Distance to the window

Note: The graph depends on the room characteristics and can be determined by measurement.

Two-step light control

All lines of luminaires of a room must be controlled by a single brightness controller as the overlapping receiver cones of separate control groups would create oscillations.

However, oscillations can occur within a single control group (e.g. caused by passing clouds). These effects can be countered by increasing the cycle period (which can be adjusted in the application program) reducing them to a frequency which is appropriate.

Calibration Notes

In order to guarantee a correct calibration the room must be completely furnished including floor cover, panelling and furniture. In addition, only the Luxmeter should be placed in the receiver cone.

In order to conduct a calibration a light intensity of 200 to 1900 Lux is required in the room.

The highest precision is achieved when using the final operating light intensity for calibration.

A warm-up period of at least 15 minutes must be considered when calibrating fluorescent lights until a constant light intensity is established required for a proper calibration.

While running the calibration, the light intensity must not change!

Constant light control

Best results are gained when using a mix of 50% artificial light and 50% daylight for calibrating a constant light control.

Example of a constant light control at 500 Lux:

Starting with pure daylight, the Luxmeter should show a value between 200 and 300 Lux when placed beneath the brightness controller. Otherwise, the blinds must be adjusted accordingly. If this is not possible, the calibration must be delayed until the daylight meets this Lux level. After that, the artificial light intensity is increased until approx. 500 Lux are reached. Now the calibration is run. For the calibration procedure the exact value must be read.

Two-step light control

Best results are gained when using a mix of 50% artificial light and 50% daylight for calibrating a two-step light control. However, the light intensity must not exceed 1900 Lux as no calibrations can be run at light intensities above that level.

Running a calibration with using artificial light exclusively is also possible. However, this slightly increases the calibration error as no daylight is available.

Brightness Controller GE 252 42 x 28 mm	5WG1 252-4AB02
---	-----------------------

Example of a two-step light control at 500 Lux:
Read light intensity with the Luxmeter beneath the brightness controller without daylight, e.g. 600 Lux. For best results, calibrations should be run with a mix of artificial light and daylight at twice the light intensity level, i.e. 1200 Lux.

Send light intensity value

Depending on the type and configuration of the lighting installed one of the two methods (as used for the constant light control and the two step light control) might be preferable.

Dimension Diagram

Dimensions in mm

Converter:

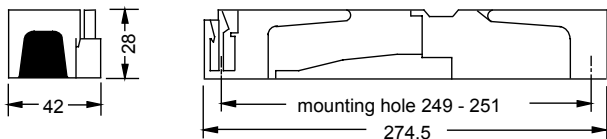

Receiver:

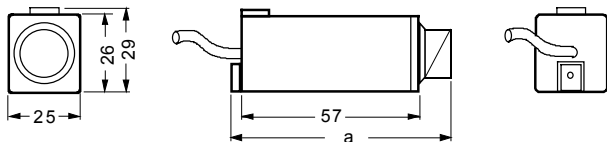

a = 77,4 mm (slanted tube)